



buffet | tabletop | bar



*SINCE 1933*

# 2024

INTERNATIONAL  
CATALOGUE

# APS – Werkstatt und Bühne für den Genuss

APS – Workshop and stage for enjoyment



family-run company  
since 1933

Reinhold Pott | Bastian Becker



- eigene Produktion in Deutschland
- 20.000 Euro-Palettenlagerplätze
- own production in Germany
- 20,000 Euro pallet storage spaces



buffet | tabletop | bar

**Assheuer + Pott GmbH & Co. KG**  
Talweg 11 | 59846 Sundern  
Germany

Phone: +49 (0) 2933 / 97 35 - 0  
info@aps-germany.de  
aps-germany.de



Visit our website!



p. 100



p. 110



p. 138



Buffet & Display

p. 176



p. 194



p. 232



Buffet & Tableware  
Melamine

p. 258



p. 302



p. 318



Tableware &  
Table Presentation

p. 358



p. 370



p. 374



Baskets

p. 390



p. 408



p. 414



Chafing Dish,  
GN Container & Transport

p. 442



p. 456



p. 494



Bar, Café & Drinkware

p. 514



p. 530



p. 548



Kitchen & Servings tools

p. 563



p. 565



p. 568



Covers & Accessories

## Ihr Mehrwert: Inspiration & Service

- ✓ aktuellste Nonfood-Trends im Sortiment
- ✓ hohe Warenverfügbarkeit



## Your added value: Inspiration & Service

- ✓ latest nonfood-trends in the range
- ✓ high availability of goods

# APS – KNOW-HOW

We only work with the raw material manufacturer who has the best technology in the industry.



## MELAMINE

- ✓ 100 % pure melamine
- ✓ BPA free, urea free
- ✓ perfect for serving dishes
- ✓ extremely break and shock resistant
- ✓ sustainable due to durability and robustness
- ✓ hygienic surfaces
- ✓ environmentally friendly due to low processing temperature
- ✓ 100 % dishwasher safe
- ✓ useable up to max. 70 °C

## STAINLESS STEEL

- ✓ hygienic surface
- ✓ durable and easy to clean
- ✓ recyclable
- ✓ good temperature conductor
- ✓ 100 % dishwasher safe



Chrome-nickel steel is used in a wide variety of products due to its attractive appearance, as a brightly polished, ground or brushed variant.

## WOOD ACACIA - BEECH - OAK - OLIVE



## PORCELAIN



## PLASTIC PP - PS - SAN - TRITAN



- ✓ high resistance to heat
- ✓ durable, no disposable plastic
- ✓ crystal clear
- ✓ hygienic surface
- ✓ easy to clean
- ✓ recyclable
- ✓ BPA free

# Präzisionsarbeit und Design für Ihren Erfolg

Precision work and design for your success



state-of-the-art  
manufacturing  
technology



eco-friendly



high  
professional  
usability

## QUALITÄT

- ✓ Jedes Produkt muss mehr als zwei Qualitätskontrollen bestehen.
- ✓ Wir verwenden nur 100 % reines Material.
- ✓ Jedes Rohmaterial wird streng geprüft.

## QUALITY

- ✓ Each product must pass more than two quality checks.
- ✓ We only use 100 % pure material.
- ✓ Each raw material is strictly tested.



APS production | Made in Germany

## DESIGN

- ✓ Unsere eigenständig entwickelten Produkte verfügen über zahlreiche Design-Patente im In- und Ausland.
- ✓ Wir entwickeln Produktlösungen für jeden individuellen Kundenbedarf.

## DESIGN

- ✓ Our independently developed products have rich / multi design patents at home and abroad.
- ✓ We develop product solutions for every individual customer need.



Design team

# DEUTSCH

## Artikel Seite

### A

Abklappbehälter	416,493
Abräumwagen	426,427
Abtropfmatte	474
Adapter / Zwischensteg	418
Allzweckgießer	329,490
Antirutschmatte	18,454
Aschenbecher	506-509
Auflaufform	83
Aufstrichmesser	536
Auslagenplatte / Kuchenplatte	154,361
Ausgießer	329,480,481,490
Ausstellblech	154,361,545
Austernmesser	533

### B

Backblech	143,423
Backform	544,552-553
Backhandschuhe	554
Baguette Korb	360,366
Bain-Marie	393-401,405,541
Bar-Caddy	474
Barlöffel	471
Barmaß	468-469
Barmatte	474
Barsieb	472,539
Becher	273,460-466,493,497
Becher Emaille	266
Behälter	89-91,350-355,432,473
Bento Box	227-228
Beschriftungsetiketten	71,346
Beschriftungskarten	344-349
Besteckablage	250,431
Besteckbehälter	23,89-91,350-355,362,381,428-430
Besteckkorb	353,367
Besteckständer	353
Bestecktaschen	325-326
Beton	88,99,111,196-197,307,295,342,344,351,452,455,507
Bierglasträger	151,503
Bitterflasche	480
Blattschale Melamin	203,222,239,248
Bonleiste	558
Bonspieß	558
Bräter	80-82,480-410
Brennpastenbehälter Edelstahl	399
Brezel- oder Wurstständer	62
Brotstation	68
Brotkorb	43,68,358-366,368-369,370-373,374-379,380-384
Brotschneidebrett	68-70
Brötchenspender Edelstahl	43
Brottasche	370-373
Buffet Box	57-58
Buffet Kühlset	20,31,126,156
Buffet Kühlset Edelstahl	31
Buffet-Set	43,106,366,387
Buffetbrett	72-74,124
Buffetgestell	29,43,59,106,366,387
Buffetkorb	43,68,358-366,368-369,370-373,374-379,380-384
Buffetleiter	104-105,108-109
Buffetschilder	113,117,344-349
Buffetständer	17,54-56,67,73,93-94,95,99,102,228,241
Buffetständer Edelstahl	228,241
Buffetständer Holz	54-56,67,95,99,102
Buffetständer Metall	17,73,93-94,98
Buffetvitrine	32-34,41
Buffetvitrine Edelstahl	32-34
Butterdose	313
Butterservierer	312
Bürste Bar	481

### C

Caddy	169,311,355,474,487
Cappuccinotasse	137,333,495
Cerealispender	23,100-103
Cerealispender Edelstahl	23,100-103
Chafing Dish	84-85,390-400,402-405
Chafing Dish Rolltop	398,400,405
Champagnerkühler	446-447
Cocktailmesser	473,531

### D

Darioform	545
Deckel	38,40,104,251,278,417,421,554,572-574
Deckel Edelstahl	417-418
Dekoriermesser	473,533
Dip-Schälchen	47,205,243-246,257,270-271
Dispenser Saft	22,113,116,118,120
Dispenser Milch	22,116-117,120
Dosier- & Vorratsflasche	480,548-549
Dosierer Zucker	330-331,491-492
Dosierpumpe	550
Dosierspender	550
Dressingtopf Edelstahl	71
Dressingtopf Melamin	71
Dressingtopf Porzellan	71

### E

Eier-Box	432,550
Eierbecher	250,313
Eierkorb	361
Eierschneider	537
Eimer	263,433,476-477,543
Eis-Kugel-Former	478
Eisbox	26,476
Eiseimer	443,476-477
Eisportionierer	528,559
Eisschaufel	477
Eiswaffel-Ständer	559
Eiswasserröhre	110,124-125,454
Eiswürfelform	478
Eiszange	479,523
Eiszerkleinerer	477
Emaille-Artikel	201,266-267,313
Entkerner	532
Espressotasse	136,332,496
Etagère	19,54-55,60-66,161,214,219

### F

Fadenschneider	530
Fast-Food Tablett	152,504
Feuerzangenbowle-Set	317,407
Fingerfood-Löffel	48,230,248-249
Flambierbrenner	559
Flasche	122-125,299,274,480,482-483,548-549
Flaschenhalter Wein	453
Flaschenkühler	53,71,126,128,256,443-444,446-447,449-452,460,483
Flaschenöffner	128,482
Folien-Abreißvorrichtung	558
Fondue-Set	317,407
Frischhaltedeckel	278

### G

Gabel Fleisch	515,518-519
Gabel Salat	514,250,517,556
Spitzsieb	539
Gebäckpalette	169
Gebäckzange	525-528
Gemüsehobel	541
Getränkspender	18,111-115,455
Getränkewanne	127,447
Gewürzstreuer	310
Gläsereschiene	465
Glasumrandler	474
Glocke	505
Gourmetlöffel	273
GN Abtropfgitter	418,421
GN Behälter	49,139,251,414-416,419-425
GN Behälter Edelstahl	139,414-416
GN Besteckbehälter	23,90-91,362,428-429
GN Buffetgestell	366
GN Buffetleiter	108-109
GN Buffetständer	17,228
GN Buffetvitrine Edelstahl	31-34
GN Chafing Dish	391,393-394,396,398-400
GN Deckel	251,417-419,421,424
GN Haube	139,188,366,369,379,562-564
GN Korb	26,358-361,362-366,369,378,380
GN Korb Metall	378,380
GN Korb Polypropylen	358-366,369
GN Naturschieferplatte	16,30,157
GN Partyplatte	150
GN Rost	423
GN Schale Melamin	175,179,185,213
GN Servierbrett	503
GN Serviergestell	27
GN Tablett	25,30,52,138 139,174,176,180,185,188,190,192,197,198,216,217,218-219,227,235,237-238,247,423
GN Tablett Edelstahl	138-139,247
GN Tablett Melamin	30,174,176,180,185,188,190,192,197,198,216,217,218-219,227,235,237-238
GN Tablett Porzellan	25,423
GN Wanne	25,30
Gourmetgläser	277

### H

Häkelkorb	372
Haube	24-27,31-37,45,67,72,74,138-142,146-149,155,160,161,188,211,241,365-366,369,379,405,562-571
Haube Rolltop	20,24,26-27,31-37,74,142,149,160,241,330,365-366,405,492,565-567
Haube Rolltop Edelstahl	405
Haubenhalterung	45
Heizelement	18,85,129,398-399,403,404,413
Hobel	62,533,541
Holzbox	15,171,283,311,386-387
Honiglöffel	557
Hummerbrecher	537
Hygieneschutz	17,42,43,62

### I

Induktionskochplatte	85,390-397,403-404
Induktionsstation	18,85,403
Infrarotwärmelampe	51,53,406
Iso-Dispenser	118
Isolierkanne	129-131

### K

Kaffeebecher	266,497
Kaffeedispenser Edelstahl	129-131,413
Kaffeekanne	489
Kaffeetasse	137,333,495
Kanne	117,122-125,129-134,263,412,485-489,492
Kanne Saft	122-125,247
Karaffe Glas	122-126
Kartenhalter	343-349
Käsehobel	533
Kaviarkühler	149
Kellnermesser	482
Kreide-Marker	17,28,344,346,386
Kochtopf	81-82,409-410
Konditorplatte	240
Konferenzkühler	483
Korb Edelstahl	262-263,382-383
Korb Metall	265,373-380,383-385
Korb Polypropylen	353,358-369
Korkenöffner	483
Kronkorkenschale	128
Kugelausstecher	530
Kühlakku	21,32-40,128,156,575
Kühlbox	20,31-40,126,156
Kühlkaraffe	124-125
Kühlmanschette	453
Kühlschale	21,38-40
Kühltablett	24,36,31

### L

Ladestation	340-341,440-441
Likör- und Fondanttrichter	541
Limettenpresse	484,551
Löffel	48,183,230,248-250,273,300,431,471,514-521,528,539,555-557
Löffelablage	431
Löffel Backen	539
Löffel Feinkost	555
Löffel Fingerfood	48,230,247,248-249
Löffel Frittieren	539

Löffel Gourmet	273
Löffel Salat	250,514,517,556
Löffel Saucen, Dressing	515,555
Löffel Spaghetti	516,521,524
Lunchbox	511

### M

Magnet-Messerhalter	558
Mandoline	541
Mehrwegbecher	497
Menage	294-302,308
Messbecher	542-543
Messlöffelsatz	528
Metallrahmen für Induktionskochplatte	393-395,404
Milchdispenser	22,116
Milchgießer/-kännchen	329,490,492
Milchkanne	22,116,117
Minis	47,106,242,244-249,329,490,492
Moscow Mule Becher	460-462
Mühle Pfeffer	301-309
Mühle Salz	301-309
Multi Rack Edelstahl	75
Multibox	133
Muscheltopf	293
Müslispender	23,100-103

### N

Naturschieferplatte	16,30-31,63,149,156-161,165-166,284,288-289,304
---------------------	---

### P

Panierstation	551
Parmesan Menage	300-301
Partyplatte	150
Passiersieb	538-539
Pendelschäler	531-532
Permanent-Ausgießer	481
Pfanne	142,260-261,411
Pfannenwender	52,515
Pfeffermühle	301-309
Pizzaballenbehälter	432,554
Pizzazange	479,529
Pitcher	122,124-126,453
Pizzaform	552-553
Pizzaschaufel	553
Pizzaschneider	532,537,554
Platzsets	318-325
Platzteller	315
Podest	17,18,123
Pommes-Frites-Seiher	540
Porzellan	84,136-137,332-333,394,397,402,494-495
Pump-Isolierkanne	129-131

### Q

Quetschflasche	548-549
----------------	---------

### R

Rechnungstablett	316,505
Regalwagen	341,426-427,441
Reinigungsbürste	475,481
Rezeptionsglocke	505
Rolltop-Set	16,149
Rührbecher	543
Rührglas	480

### S

Saftdispenser	22,113,116,118-120
Saftkanne	122,124,125
Salatbesteck	250,514,517,521,524-525,556
Salatzange	25,521,524-527
Salat-Löffel	514,517,556
Salzmühle	302-310
Samowar	134,412,485
Sauciere	314,315
Schälchenspender	106
Schale Aluminium	53,265,373
Schale Beton	99
Schale Edelstahl	79,142,257,263-264,272,383
Schale Emaille	266-267,313
Schale Glas	104,105,574
Schale Holz	96-98,164,170-171,280-281,285,290-291
Schale Melamin	175,177-219,221,229,231-247,249,293

Schaufel Eis	477	237,238,241,247,256,282,283,286,289,
Schaufel	287,477,547,553,556,557	290,292,316,329,361,423,425,492,
Schaufel Mehl	547	500-505
Schaumlöffel	516,521	Tablett Edelstahl 24,25,138,147,149,247,
Schaumspesering	544	256,292,316,500,501,502,505
Schiefer	16,28,30,31,62,63,156,156-161,	Tablett Fast Food 152,504
	165,166,218,220,284,288,289,304,386	Tablett Holz 24,45,65,68,96,148,163,282,
Schilder	344-346,386	283,286,290,329,492
Schlüsselschnur	483	Tablett Melamin 25,30,65,68,70,145,151,
Schneebesen	537	158,174,176,178,180,182,185,188,189,
Schneidbrettständer	559	190,191,192,197,198,199,200,
Schneidebrett	25,44,68,70,473	207,210,216,217,218,219,220,221,
Schöpflöffel	514,516,518,519,521	224,225,227,230,232,233,235,237,
Seiher	540	238,241,247,289,500,502,503
Sektglas	335,456	Teebox 133,487
Sektkühler	127,442-444,448,449	Teebrühsieb 492
Senftöpfchen	296	Teekanne ASIA 132,282,486
Servierbox	15,16,26,28-30,57,58,68,78,	Teigbehälter 432,554
	107,133,171,269,282,283,311,386,387	Teigschaber / Abstecher 536
Serviertöpfchen	149,260,261	Teigspachtel 545
Servier- / Tortenplatte Edelstahl	147,154	Teller Emaille 201,267
Servier- / Tortenplatte Holz	154	Teller Fingerfood 247
Servier- / Tortenplatte Melamin	153,240	Teller Melamin 96,112,175,176,177,178,
Servierbrett	162-169,171,281-288	180,181,182,186,191,193,194,199,200,
Servier-Frittierkorb	262	201,202,207,224,227,233,247
Serviergabel	515	Thermometer 489
Serviergestell	60-62,106,278	Thermo Tablett-Set 35
Servierkelle	269	Thermo-Set 37
Servierkorb	26,256,358-366,368,369,	Tin in Tin Shaker 466
	372-385	Tischrestebehälter 354-355
Servierlöffel	250,514,516,517-219,521	Tischschäufsteller 346,348
Servierpfanne	142,260,261	Tischkartenhalter 343-349
Servierpfanne Gusseisen	268	Tischkrümelentferner 315,505
Servierset	183	Tischleuchte 336-341,436-441
Serviertablett	143-145,151,163,283,	Tischsets 318-328
	292,501-503	Tortenheber 515,517
Servierwagen	426,427	Tortenmesser 517
Servierzange	526-529	Tortenplatte 147,153-154,160,240
Serviettenhalter	86-88	Tortenring 544
Serviettenringe	316	To-Go Becher 497
Serviettentaschen	325,326	Transportwagen 426,427,341,441
Shaker	463,466,467	Tretbeutelhalter 510
Sieb	472,492,538,539	Trichter 433,541,546
Snackbox	269,282	Trinkbecher 114-115,463,466,457-459
Snackholder	262-264	Trinkflasche 121,498-499
Snackpresenter	41	Trinkglas 113,459
Snackspender	273,464	Trinkhalme 475
Spachtel	536	Tropfenschale Melamin 112,115,455
Spaghettizange	521,523-526	<b>U</b>
Spargelzange	526	Universalbox 78
Sparschäler	531	Universalkanne 488-489
Speisenwärmer	51,406	Untersetzer Edelstahl 316
Spritzflasche	480,299	Untersetzer Kork 114-115
Standascher	509	Untersetzer Melamin 112
Ständer	17,62,67,73,92-95,98,99,102,103,	Untersetzer Naturschiefer 159,289,304
	106,215,228,241,293,295,301,344,347,	Untertasse 136-137,332-333,594-595
	541,559	Unterteller 112
Ständer Wein- / Sektkühler	445	<b>V</b>
Staubkappen	481	Vase 342
Stielglas	335	Verschluss Wein / Champagner 481
Stielkasserolle	258-261	Vorspeisenzange 524
Stift	346	Vorratsglas 76-78
Stößel	470	<b>W</b>
Stövchen	133,487	Wachspapier 143,159,169,264,282,292,500
Streichpalette	534	Wanne 25,127,432
Streuer	309-310,540	Warenträger 320
Streuer Pfeffer	309-310	Wärmebrücke 51,53,406
Streuer Salz	309-310	Wärme-Kies 405
Superbox	28-30,386-387	Warnschild 550,575
Suppenkelle	517	Wasserbadschüssel 541
Suppentopf	401	Wasserkanne 122-125
Sushiboard Holz	162,286	Wasserspender 110-115,454-455
Sushiboard Melamin	180,182,207	Weck Gläser 274-278,289
<b>T</b>		Weinglas 335,456
Table Caddy	169,311,355,474	Weinkühler 127,442-444,448-449
Tablett	19,24,25,30,45,49,52,54,55,60-66,	Weinkühlerständer 445
	68,70,96,138-147,143-145,148,149,	Wender 516,519-520,534-535
	151,152,158,161,163,174,176,178,180	Windaschenbecher 506-509
	182,185,188,189,190,191,192,197,198,	Windlicht 342
	199,200,207,210,214,216,217,218,219,	<b>Z</b>
	220,221,224,225,227,230,232,233,235,	Zange 479,521-529

## ENGLISH

item	page
<b>A</b>	
adapter	418
air pot	129-131
airtight cover	278
appetizer tong	524
ashtray	506-509
asparagus tongs	526
<b>B</b>	
baguette basket	360,366
bain marie bailing bowl	541
Bain-Marie	393-401,405,541
baking mittens	554
baking pan	544,552-553
baking sheet	143,423
bar caddy	474
bar knife	473,531
bar spoon	471
bar strainer	539,472
barrel mug	273,460-466,493,497
basket metal	265,373-380,383-385
basket polypropylene	353,358-369
basket stainless steel	262-263,382-383
beaker	266
beer rack	151,503
Bento Box	227-228
beverage dispenser	18,111-115,455
beverage tub	127,447
bill presenter	316,505
bill rail	558
bill spike	558
bottle	122-125,299,274,480,
	482-483,548-549
bottle cooler	53,71,126,128,256,
	443-444,446-447,449-452,460,483
bottle fuel	399
bottle opener	128,482
bowl aluminium	53,265,373
bowl concrete	99
bowl enamel	266-267,313
bowl glass	104,105,574
bowl holder	106
bowl melamine	175,177-219,221,229,
	231-247,249,293
bowl stainless steel	79,142,257,263-264,
	272,383
bowl wood	96-98,164,170-171,
	280-281,285,290,291
bread basket	370-373
bread station	68
Breadbox	68,43,358-366,368-369,
	370-373,374-379,380-384
breeding set	551
bucket	263,433,476-477,543
buffet basket	68,43,358-366,368-369,
	370-373,374-379,380-384
buffet box	57-58
buffet ladder	104-105,108-109
buffet set	43,106,366,387
buffet signs	113,117,344-349
buffet stand	17,29,43,54-56,59,67,73,
	93-94,95,99,102,106,228,241,366,387
buffet stand metal	17,73,93-94,98
buffet stand stainless steel	228,241
buffet stand wood	54-56,67,95,99,102
buffet-board	72-74,124
butter dish	313
butter dish	312
<b>C</b>	
caddy	487,169,311,355,474
cake lifter	515,517
cake plate melamine	153,240
cake plate stainless steel	147,154
cake plate wood	154
cake setting ring	544
cake slice	517
cake stand	147,153-154,160,240
canale / decorating knife	531
canister	76-78
cap bowl	128
cappuccino cup	137,333,495
cast iron pan	268
caviar cooler	149
cereal dispenser	23,100-103
cereal dispenser stainless steel	23,100-103
Chafing Dish	84-85,390-400,402-405
Chafing Dish Rolltop	398,400,405
chalk marker	17,28,344,346,386
champagne bowl	127,442-444,
	446-447,448,449
champagne glass	335,456
champagne/wine saver	481
charging station	340-341,440-441
cheese dish	300-301
cheese slicer	533
chefs blow torch	559
chopping board	25,44,68,70,473
citrus squeezer	484,551
cleaning brush	475,481
clingfilm tear-off dispenser	558
cloche / dome cover	505
coaster cork	114-115
coaster melamine	112
coaster natural slate	159,289,304
coaster stainless steel	316
coffee cup	266,497
coffee dispenser stainless steel	129-131,413
coffee pot	489
concrete	88,111,295,351,507,99,
	196-197,307,342,344,452,455
condiment holder	473
confectionery funnel	541
conference bottle cooler	483
conical strainer	539
container	89-91,25,127,350-355,432,473
cooking pot with lid	81-82,409-410
cool collar	453
cooler	21,32-40,128,156,575
cooling bowl	21,38-40
cooling box	20,31-40,126,156
cooling box stainless steel	31
cooling carafe	124-125
cooling plates	24,31,36
corer	532
corkscrew	483
cornet stand	559
cover	38-40,104,251,278,417,421,
	379,405,562-571,24-27,
	31-37,45,67,72,74,138-142,
	146-149,155,160-161,188,211,241,
	365-366,369,554,572-574
cover holder	45
cover stainless steel	417-418
crochet rope basket	372
crumber	315,505
curler	62,533,541
cutlery bag	325-326
cutlery basket	353
cutlery dispenser	353,367
cutlery organizer	23,89-91,350-355,362,
	381,428-430
cutlery rest	250,431
cutting board	68-70
cutting board rack	559
<b>D</b>	
Dariol moulds	545
decorating knife	473,533
decorator / zester	530
delicatessen spoon	555
designation cards	344-349
dip bowl	47,205,243-246,257,270-271

dispenser	550
dispenser sugar	330-331,491-492
display	320
display plate	154,361
display tray	361,154,545
dosing pump	550
dough container	432,554
dough spatula	545
dough scraper	536
dressing pot melamine	71
dressing pot porcelain	71
dressing pot stainless steel	71
dressing/sauce spoon	515,555
drinking bottle	121,498-499
drinking cups	113, 457-459, 114-115,463, 459,466
drip mat	474
drip tray melamine	112,115,455
dust & fly cap	481
<b>E</b>	
egg basket	361
egg cutter	537
egg holder	250,313
eggs box	432,550
enamel articles	201,266-267,313
espresso cup	136,332,496
<b>F</b>	
fingerfood plate	247
fire punch bowl set	317,407
flower vase	342
fondue set	317,407
fork	515
free flow pourer	481
fry baskets	262
fry dripping tray	540
funnel	433,541,546
<b>G</b>	
glass carafe	122-126
glass rack	465
glass rimmer	474
GN basket	26,358-361, 362-366,369,378,380
GN basket metal	378,380
GN basket polypropylene	358-366,369
GN bowl melamine	175,179,185,213
GN buffet display stainless steel	31-34
GN buffet ladder	108-109
GN buffet stand	17,228,366
GN Chafing Dish	391,393-394,396,398-400
GN cover	139,188,366,369,379, 562-564
GN cutlery organizer	23,90-91,362,428-429
GN grid	423
GN natural slate tray	16,30,157
GN pan stainless steel	139,414-416
GN party tray	150
GN serving board	503
GN serving stand	27
GN tray	25,30,52,138-139,174,176, 180,185,188,190,192,197,198, 216,217,218-219,227, 235, 237-238,247,423
GN tray melamine	30,174,176,180,185, 188,190,192,197,198,216,217, 218-219,227,235,237-238
GN tray porcelain	423,25
GN tray stainless steel	138-139,247
GN-container	414-416,419-425,49,139,251
GN-drainer	418,421
GN-lid	251,417-419,421,424
gourmet glasses	277
graduated jug	542-543
granite chips	405
gravy boat	314,315
greaseproof paper squares	169,143,159, 264,282,292,500
<b>H</b>	
heating unit	18,85,129,398-399,403,404,413
honey spoon	557
hygienic cover	17,42,43,62

<b>I</b>	
ice ball former	478
ice box	26,476
ice bucket	443,476-477
ice cream scoop	528,559
ice crusher	477
ice cube cooling tube	110,124-125,454
ice cube maker	478
ice scoop	477
ice tongs	479,523
induction plate	85,390-397,403-404
induction station	18,85,403
insulated dispenser	118
<b>J</b>	
jigger	468-469
jug	488-489
juice dispenser	22,113,116,118,120
juice pitcher	122-125,247
<b>K</b>	
key cord	483
<b>L</b>	
labeling labels	71,346
labels	344-346,386
ladle	514,516,518,519,521
leaf melamine	203,222,239,248
lemon slice squeezer	493
lime press	484,551
lobster cracker	537
lunchbox	511
<b>M</b>	
magnetic knife rack	558
mandolin	541
meat fork	515,518-519
melon baller	530
menage	294-302,308
milk dispenser	22,116-117,120
milk jug	329,490,492
mini bowl	47,106,242,244-249,329,490,492
mixing glass	480
Moscow Mule barrel mug	460-462
mousse ring	544
muddler	470
multi rack stainless steel	75
multibox	133
mussel pot	293
mustard glass	296
<b>N</b>	
napkin bag	325,326
napkin holder	86-88
napkin rings	316
natural slate tray	16,30-31,63,149,156- 161,165-166,284,288-289,304
non slip mat	18,454
oyster knife	533
<b>P</b>	
pan	142,260-261,411
party spoon	48,230,248-249,273
partytray	150
pastry spatula	169
pastry tongs	525-528
pedal bin	510
peeler	531
pen	346
pepper mill	301-309,310
pitcher	117,122-125,129-134, 263,412,485-489,492
pizza cutter	532,537,554
pizza dish	552-553
pizza dough container	432,554
pizza peel	553
placemat	318-325
plate enamel	201,267
plate melamine	96,112,175,176,177,178, 180,181,182,186,191,193,194,199,200,201, 202,207,224,227,233,247
plate tray	315
plate warmer	51,406
podest	17,18,123
porcelain	84,136-137,332-333,394,397, 402,494-495
pourers	329,480,481,490

pouring container	480,548-549
pretzel-/ sausage stand	62
<b>R</b>	
refrigerated buffet display	20,31,126,156
reusable cup	497
ring bell	505
roll dispenser stainless	43
rolltop cover	20,24,26-27,31-37,74, 142,149,160,241,330, 365-366, 405,492,565-566
rolltop set	16,149
rolltop-cover stainless steel	405
<b>S</b>	
salad fork	250,514,517,556
salad spoon	250,514,517,556
salad spoon + fork	250,514,517, 521,524-52,556
salad tongs	25,521,524-527
salt mill	301-309,310
samovar	134,412,485
sandwich knife	536
saucer	112,136-137,332-333,594-595
sauté pan / mini sauce pan	258-261
scoop	287,477,547,553,556,557
scoop flour	547
scraper	536
service trolley	426,427,341,441
serving basket	26,256,358-366, 368,369,372-385
serving board	162-169,171,281-288
serving box	15,16,26,28-30,57,58,68, 78,107,133,171,269,282,283,311,386,387
serving cup	262-264
serving set	183
serving spoon	514,516,517-219,521,250
serving stand	17,60-62,67,73, 92-95,98,99,102,103,106,215,228,241, 278,293,295,301,344,347,541,559
serving tongs	526-529
serving trolley	426,427
serving trowel	269
set measuring spoon	528
shaker	309-310,463,466,467,540
showcase	32-34,41
showcase stainless steel	32-34
skimmer	516,521
skimmer spoon	539
slate	16,28,30,31,62,63,156,156-161,165, 166,218,220,284,288,289,304,386
small serving pot	149,260,261
snack dispenser	273,464
snack tray	152,504
snackbox	269,282
snackpresenter	41
snap mesh tea ball	492
soup ladle	517
soup pot	401
spaghetti spoon	516,521,524
spaghetti tongs	521,523-526
spatula	534
spice shaker	310
spider spoon	539
spoon	48,183,230,248-250,273,300, 431,471,514-521,528,539,555-557
spoon rest	431
spray bottle	480
squeeze bottle	299,548-549, 480
stainless steel frame for induction plate	393-395,404
stand for wine / champagne bowl	445
standing ashtray	509
stirring cup	543
strainer	472,492,538,539,540
straws	475
sugar dispenser	329-331, 491-492
sugar pot	492
superbox	28-30,386-387
sushiboard melamine	180,182,207
sushiboard wood	162,286
swivel peeler	531-532

<b>T</b>	
table caddy	169,311,355,474
table garbage bin	354-355
table lamp	336-341,436-441
table mats	318-328
table stands	343-349, 346,348
tapping container	416,493
tea-box	133,487
teapot ASIA	132,282,486
teapot warmer	133,487
thermal bridge	51,53,406
thermo set	37
thermo tray	35
thermometer	489
To-Go cup	497
tong	479,521-529
tray	19,24,25,30,45,49,52,54,55,60-66, 68,70,96,138-147,143-145,148,149, 151,152,158,161,163,174,176,178,180, 182,185,188,189,190,191,192,197,198, 199,200,207,210,214,216,217,218,219, 220,221,224,225,227,230,232,233,235, 237,238,241,247,256,282,283,286,289, 290,292,316,329,361,423,425,492, 500-505
tray melamine	25,30,65,68,70,145,151, 158,174,176,178,180,182,185, 188,189,190,191,192,197,198,199,200, 207,210,216,217,218,219,220,221,224, 225,227,230,232,233,235,237,238,241, 247,289,500,502,503
tray stainless steel	500,501,502,505, 24,25,138-147,149,247,256,292,316, 283,286,290,329,492
tray wood	24,45,65,68,96,148,163,282, 283,286,290,329,492
trolley	341,426-427,441
turner	515,52, 516,519-520,534-535
tweezer	479,529
<b>U</b>	
universal box	78
<b>V</b>	
vacuum jug	129-131
<b>W</b>	
waiter's corkscrew	482
warning sign	550,575
water pitcher	122-125
Weck-bottles	274-278,289
whisk	537
wind lights / candle holder	342
wine bowl	127,442-444, 448-449
wine glass	335,456
winebottle-stand	453
woodbox	15,171,283,311,386-387

 <b>ESPAÑOL</b>	
<b>artículos</b>	<b>pág.</b>
<b>A</b>	
abre ostras	533
abridor	128,482
acumulador de frío	21,32-40,128,156,575
adaptador	418
aro anti-goteo melamina	112,115,455
aro de tarta	544
aro redondo para semifríos	544
artículos esmaltados	201,266-267,313
azucarero	330-331,491-492
<b>B</b>	
bajo plato	315
bandeja	19,24,25,30,45,49,52,54,55, 60-66, 68,70,96,138-147,143-145, 148,149,151,152,158,161,163,174,176, 178,180, 182,185,188,189,190,191, 192,197,198,199,200,207,210,214,216, 217,218,219,220,221,224,225,227,230, 232,233,235,237,238,241,247,256,282, 283,286,289,290,292,316,329,361,423, 425,492,500-505



bandeja acero inoxidable	24,25,138-147,149,247,256,292,316,500,501,502,505	cenicero de pie	509	dispensador de cereales acero inoxidable	23,100-103	GN soporte buffet	27,366
bandeja autoservicio y snacks	152,504	cepillo de limpieza	475,481	dispensador de film	558	GN soporte para buffet	17,228
bandeja con alturas	19,54-55,60-66,161,214,219	cesta acero inoxidable	262-263,382-383	dispensador de leche	22,116-117,120	GN tabla de servir	503
bandeja de pizarra natural	16,30-31,63,149,156-161,165-166,284,288-289,304	cesta de baquette	360,366	dispensador de salsa	550	GN tapa	251,417-419,421,424
bandeja isotérmica	37	cesta de buffet	43,63,358-366,368-369,370-373,374-379,380-384	dispensador de snacks	273,464	granulado térmico	405
bandeja madera	24,45,65,68,96,148,163,282,283,286,290,329,492	cesta de cuerda de ganchillo	372	dispensador de zumo	22,113,116,118,120	<b>H</b>	
bandeja melamina	25,30,65,68,70,145,151,158,174,176,178,180,182,185,188,189,190,191,192,197,198,199,200,207,210,216,217,218,219,220,221,224,225,227,230,232,233,235,237,238,241,247,289,500,502,503	cesta de huevos	361	dispensador de panecillos acero inoxidable	43	hormigón	88,111,295,351,507,99,196-197,307,342,344,452,455
bandeja para sushi melamina	180,182,207	cesta metal	265,373-380,383-385	dispensador en escalera acero inoxidable	75	huevo	250,313
bandeja party	150	cesta para servir	26,256,358-366,368,369,372-385	dispensador isotérmico	118	<b>I</b>	
bandeja pastelera	154,423,143,361,545	cesta polipropileno	353,358-369	embudo	433,541,546	infusor de té, pinza con malla	492
bandeja tartas acero inoxidable	147,154	cestitas para el servicio mesa	262	embudo dosificador	541	<b>J</b>	
bandeja tartas madera	154	Chafing Dish	84-85,390-400,402-405	enfriador de botellas	53,71,126,128,256,443-444,446-447,449-452,460,483	jarra	122,124-126,117,122-125,129-134,263,412,453,488-489,492
bandeja tartas melamina	153,240	Chafing Dish Rolltop	398,400,405	enfriador de caviar	149	jarra de agua	122-125
bandeja termo	35	champañera	446-447	enfriador múltiple	483	jarra de leche	329,490,492
bandejas refrigeradas	24,31,36	colador	463,466,467	escurridor de fritos	540	jarra de vidrio	122-126
baño María	393-401,405,541	colador cónico	472,492,538,539,540	espátula	516,519-520,534-535,515,52	jarra de zumo	122-125,247
barra magnética para cuchillos	558	colador de cóctel	472,539	espátula masa	545	jarra enfriadora	124-125
barreño botellines	127,447	conjunto aperitivo	294-302,308	espátula plancha	536	jarra graduada	542-543
batidor	537	contenedor knock-out	416,493	espumadera	516,521	jarra termo	129-131
Bento Box	227-228	copa de champán	335,456	espumadera para fritos	539	juego de cucharas medidoras	528
bol refrigerado	21,38-40	copa de vino	335,456	estación de carga	340-341,440-441	<b>L</b>	
bolsa cubiertos	325-326	corta huevos	537	estación de empanado	551	lámpara de mesa	336-341,436-441
bolsa de servilletas	325,326	corta pasta	536	estación de inducción	18,85,403	llavero enrollable	483
bomba dosificadora	550	cortador de pizza	532,537,554	estación pan	68	<b>M</b>	
bote	76-78	cubeta	25,127,432	esterilla antideslizante	18,454	mandolina	541
bote de mostaza	296	cubierta higiénica antialiento	17,42,43,62	esterilla escurridora	474	manoplas de panadero	554
bote dosificador flexible	548-549	cubitera	26,476	etiquetas	71,346,344-346,386	mantelín	318-328
bote vertedor universal	329,490	cubitera isotérmica	443,476-477	expositor	320	mantequera	313
botella	122-125,299,274,480,482-483,548-549	cubitera para cava	127,442-444,448,449	expositor buffet	29,43,59,106,366,387	mantequillera	312
botella „store & pour”	480,548-549	cubitera para vino	127,442-444,448,449	expositor buffet frío	20,31-40,126,156	marco de acero inoxidable para placa de inducción	393-395,404
botella de combustible líquido	399	cubo	369	expositor buffet frío acero inoxidable	31	marco pastelero	544,552-553
botella exprimible	480,299	cuchara	48,183,230,248-250,273,300,431,471,514-521,528,539,555-557	expositor de buffet	17,54-56,67,73,93-94,95,99,102,228,241	marmita	401
botes especieros	310	cuchara de espaguetis	516,521,524	expositor de buffet acero inoxidable	228,241	medidor jigger	468-469
<b>C</b>		cuchara de miel	557	expositor de buffet madera	54-56,67,95,99,102	mejillonera	293
caballetes buffet	113,117,344-349	cuchara gourmet	273,555	expositor de buffet	17,73,93-94,98	molde de cubitos de hielo esféricos	478
caballetes de mesa	346,348	cuchara para ensalada	250,514,517,556	expositor para tartas	154,361	molde de pizza	552-553
cacerola	142,260-261,411	cuchara para helado	528,559	exprimidor cítricos	551,484	molde para cubitos de hielo	478
caddy	169,311,355,474,487	cuchara para hornear	539	<b>F</b>		molinillo de pimienta	301-310
caddy de mesa	169,311,355,474	cuchara para servir	250,514,516,517-519,521	fiambarrera	511	molinillo de sal	301-310
cafetera	489	cuchara party	48,230,247,248-249	flaneras	545	mortero	470
caja comida	15,16,26,28-30,57,58,68,78,107,133,171,269,282,283,311,386,387	cucharilla de cóctel	471	florero	342	Moscow Mule taza	460-462
caja de buffet	57-58	cucharón	514,516,518,519,521	fuelle en forma de hoja melamina	203,222,239,248	multibox	133
caja de pan para buffet	68,43,358-366,368-369,370-373,374-379,380-384	cucharón de salsa/aliño	515,555	fuelle para la mesa	260,261,142	<b>O</b>	
caja dispensadora	78	cucharón de sopa	517	funda de frío	453	olla con tapa	81-82,409-410
caja madera	15,171,283,311,386-387	cuchillo acanalador	473,533	<b>G</b>		olla pequeña de servir	149,260,261
caja para huevos	432,550	cuchillo de decoración cincelador	530,531	GN bandeja	25,30,52,138-139,174,176,180,185,188,190,192,197,198,216,217,218-219,,227,235,237-238,247,423	organizador de bar	474
caja para té	133,487	cuchillo para cóctel	473,531	GN bandeja acero inoxidable	138-139,247	<b>P</b>	
calentador de tetera	133,487	cuchillo para untar	536	GN bandeja de pizarra natural	16,30,157	pajas	475
calienta platos	51,406	cuenco	79,142,257,263-264,272,383	GN bandeja melamina	30,174,176,180,185,188,190,192,197,198,216,217,218-219,227,235,237-238	pala	287,477,547,553,556,557
campana	24-27,31-37,45,67,72,74,138-142,146-149,155,160-161,188,211,241,365-366,369,379,405,562-571	cuenco aluminio	53,265,373	GN bandeja party	150	pala de hielo	477
campana esférica	505	cuenco de vidrio	104,105,574	GN bandeja porcelana	25,423	pala de pizza	553
campana rolltop	20,24,26-27,31-37,74,142,149,160,241,330,365-366,405,492,565-567,565-566	cuenco esmaltado	266-267,313	GN campana	139,188,366,369,379,562-564	pala de tartas	515,517
campana rolltop acero inoxidable	405	cuenco hormigón	99	GN cesta metal	378,380	pala para harina	547
candelabro	274	cuenco madera	96-98,164,170-171,280-281,285,290,291	GN cesta polipropileno	358-366,369	paleta para servir	269
cantimplora	121,498-499	cuenco melamina	175,177-219,221,229,231-247,249,293	GN Chafing Dish	391,393-394,396,398-400	paleta pastelera	169
carro	341,426-427,441	cuenco mini	47,106,242,244-249,329,490,492	GN cubeta	30,25,49,139,251,414-416,419-425	panera	370-373
carro de servicio	331,426,427,441	cuenco para chapas	128	GN cubeta acero inoxidable	139,414-416	papel alimenticio	169,143,159,264,282,292,500
cazo para baño maría	541	cuenco para dip	47,205,243-246,257,270-271	GN cuenco melamina	175,179,185,213	papelera de sobremesa	354-355
cazo recto bajo	258-261	<b>D</b>		GN dispensador buffet en escalera	108-109	pedestal	17,18,123
cenicero	506-509	descorazonador	532	GN escurridor	418,421	pedalator reversible	531-532
		dispensador buffet en escalera	104-105,108-109	GN expositor buffet acero inoxidable	31-34	picadora de hielo	477
		dispensador de bebidas	18,111-115,455	GN porta cubiertos	23,90-91,362,428-429	pie porta champañera / vino	445
		dispensador de bocadillos	41	GN rejilla	423	pie porta vino	445
		dispensador de café acero inoxidable	413,129-131			pinchanotas	558
		dispensador de cereales	23,100-103			pinza	479,521-529

pinza para espárragos	526
pinza para pasteles	525-528
pinza universal	526-529
pizarra	16,28,30,31,62,63,156,156-161,165,166,218,220,284,288,289,304,386
placa de inducción	85,390-397,403-404
platicillo	112,136-137,332-333,594-595
plato esmaltado	267,201
plato melamina	96,112,175,176,177,178,180,181,182,186,191,193,194,199,200,201,202,207,224,227,233,247
plato para el aperitivo	247
polvoreador	540,309-310
porcelana	84,136-137,332-333,394,397,402,494-495
porcionador de pastel	517
porta cubierto	23,89-91,350-355,362,367,381,428-430
porta cuenta	316,505
porta menú	343-349
porta vasos de cerveza	151,503
portafichas	558
porta-tarjetas	343-349
portavelas antiviento	342
posavasos acero inoxidable	316
posavasos corcho	114-115
posavasos melamina	112
posavasos pizarra natural	159,289,304
prensa de limón	484,551
punto térmico	51,53,406
pulverizador licores	480
<b>Q</b>	
quesera parmesano	300-301
<b>R</b>	
rack de copas	465
rack dispensador de cuencos	106
rebanador de queso	533
recipiente de ingredientes	473
recipiente organizador	350-355,432,473,89-91
recipiente para masa	554,432
recipiente para masa y bolas de pizza	432,554
recogemigas	315,505
reposa cuchara	250,431
resistencia	18,85,129,398-399,403,404,413
ribeteador de vasos	474
rizador	62,533,541
rotulador	346
rotulador de tiza	17,28,344,346,386
<b>S</b>	
sacacorchos	483
sacacorchos de camarero	482
salsera	314,315
salsera acero inoxidable	71
salsera melamina	71
salsera porcelana	71
samovar	134,412,485
sartén de hierro fundido	268
señal de advertencia	550,575
Servidor de ensalada	250,514,517,521,524-52,556
servilletero	86-88
servilleteros/aros	316
set de buffet	43,106,366,387
set de buffet refrigerado	20,31,126,156
set para fondue	317,407
set para ponche caliente	317,407
set para servir	183
set rolltop	16,149
snackbox	269,282
soplete de cocina para flambeo	559
soporte	17,55,62,67,73,92-95,98,99,102,103,106,215,228,241,293,295,301,344,347,541
soporte a pedal	510

soporte campana	45
soporte cucuruchos	559
soporte de pretzels o salchichas	62
soporte para botella de vino	453
soporte para pastel	147,153-154,160,240
soporte para tablas de cortar	559
soporte platos	60-62,106,278
superbox	28-30,386-387
<b>T</b>	
tabla de corte	68-70
tabla de servir	162-169,171,281-288
tabla para cortar	25,44,68,70,473
tabla para el buffet	72-74,124
tapa	38-40,104,251,278,417,421,554,572-574
tapa acero inoxidable	417-418
tapa hermética	278
tapete escurridor	474
tapón antipolvo	481
tapón vertedor	481
tarjetas	344-349
tarros gourmet	277
taza	273,460-466,493,497
taza de café	266,497
taza de cappuccino	137,495,333
taza de espresso	136,332,496
tenedor de carne	515,518-519
tenedor de ensalada	250,514,517,556
tenedor de servicio	515
termómetro	489
tetera ASIA	132,282,486
timbre	505
tubo enfriador para cubitos	110,124-125,454
<b>V</b>	
vaciador de melón redondo	530
vaso	113,459
vaso agitador	543
vaso coctelero	266
vaso mezclador vertedor	480
vaso para servir	262-264
vaso reutilizable	497
vaso To-Go	497
vasos	114-115,457-459,463,466
vertedor continuo	481
vertedores	329,480,481,490
vitrina de buffet	32-34,41
vitrina de buffet acero inoxidable	32-34
<b>W</b>	
Weck-botellas	274-278,289

## FRANÇAIS

<b>item</b>	<b>pág.</b>
<b>A</b>	
accumulateur de froid	21,32-40,128,156,575
adaptateur	418
anneau coupe-gouttes mélamine	112,115,455
anneaux à serviettes	316
ardoise	16,28,30,31,62,63,156,156-161,165,166,218,220,284,288,289,304,386
articles en émail	201,266-267,313
assiette de présentation	315
assiette émail	201,267
assiette mélamine	96,112,175,176,177,178,180,181,182,186,191,193,194,199,200,201,202,207,224,227,233,247
assiette pour apéritif	247
<b>B</b>	
bac	25,127,432
bac knock-out	416,493
Bain-Marie	393-401,405,541
barre aimantée pour couteaux	558
barre porte-bons	558
base bois	15,171,283,311,386-387

bassine à glace	127,447
Bento Box	227-228
béton	88,111,295,351,507,99,196-197,307,342,344,452,455
beurrer	312,313
boîte à ingrédients	473
boîte à lunch	511
boîte à œufs	432,550
boîte à pain pour le buffet	68,43,358-366,368-369,370-373,374-379,380-384
boîte à thés et infusions	133,487
boîte de buffet	57-58
boîte distributrice	78
boîte-repas	15,16,26,28-30,57,58,68,78,107,133,171,269,282,283,311,386,387
bol acier inox	79,142,257,263-264,272,383
bol aluminium	53,265,373
bol béton	99
bol bois	96-98,164,170-171,280-281,285,290,291
bol émail	266-267,313
bol en verre	104,105,574
bol mélamine	175,177-219,221,229,231-247,249,293
bol mélangeur	266
bol mini	47,106,242,244-249,329,490,492
bol récupérateur de capsules	128
bol réfrigéré	21,38-40
bordeur à verres	474
bouchon anti-poussières et anti-insectes	481
bouchons verseurs	329,480,481,490
boule à thé avec pince	492
bouteille	122-125,299,274,480,482-483,548-549
bouteille store & pour	480,548-549
bouteille de combustible liquide	399
bouteille isotherme	129-131
bouteille verseuse souple	548-549
brosse lave	481,475
broyeur à glaçons	477
<b>C</b>	
caddy	487,169,311,355,474
caddy de table	169,311,355,474
cadre support inox pour plaque induction	393-395,404
caisson thermo	35
carafe en verre	122-126
casserole	142,260-261,411
casserole à moules	293
cendrier	506-509
cendrier sur pied	509
cercle à gâteaux	544
cercle à mousse rond	544
Chafing Dish	84-85,390-400,402-405
Chafing Dish Rolltop	398,400,405
chalumbeau e cuisine	559
chariot	341,426-427,441
chariot de service	426,427,341,441
chauffe-plat	51,406
chauffe-théière	133,487
chevalets de table	346,348
chinois	539
cloche	24-27,31-37,45,67,72,74,138-142,146-149,155,160-161,188,211,241,365-366,369,379,405,562-571
cloche demi-sphère	505
cloche rolltop	20,24,26-27,31-37,74,142,149,160,241,330,365-366,405,492,565-567
cloche rolltop acier inox	405
coquetier	250,313
corbeille	370-373
corbeille à baguette	360,366
corbeille acier inox	262-263,382-383

corbeille de buffet	68,43,358-366,368-369,370-373,374-379,380-384
corbeille de service	26,256,358-366,368,369,372-385
corbeille métal	265,373-380,383-385
corbeille polypropylène	353,358-369
coupe-œufs	537
coupe-pâte	536
coupe-pizza	532,537,554
couteau à huitres	533
couteau à tarte	517
couteau à tartiner	536
couteau cannelé	473,533
couteau cocktail	473,531
couteau tranche-fromage	533
couteau zesteur	530
couteau zesteur cannelé	531
couvercle	38-40,104,251,278,417,421,554,572-574
couvercle acier inox	417-418
couvercle hermétique	278
couvert à salade	250,514,517,521,524-52,556
cuillère	48,183,230,248-250,273,300,431,471,514-521,528,539,555-557
cuillère à cocktail	471
cuillère à glace	528,559
cuillère à miel	557
cuillère à salade	250,514,517,556
cuillère à sauce	515,555
cuillère à spaghetti	516,521,524
cuillère de service	250,514,516,517-219,521
cuillère gourmet	273,555
cuillère party	48,230,247,248-249
cuillère pâtisserie	539
<b>D</b>	
décapsulateur	128,482
dénoyateur	532
dérouleur de film	558
distributeur de petits pains acier inox	43
distributeur à jus	22,113,116,118-120
distributeur à lait	22,116-117,120
distributeur de boisson isothermique	118
distributeur de boissons	18,111-115,454,455
distributeur de café acier inox	129-131,413
distributeur de céréales	23,100-103
distributeur de céréales acero inox	23,100-103
distributeur de snacks	273,464
doseur à sauce	550
<b>E</b>	
écumoire	516,521
égouttoir à friture	539-540
entonnoir	433,541,546
entonnoir à piston	541
étagère	19,54-55,60-66,161,214,219
étiquettes	71,346,344-346,386
<b>F</b>	
flacon pulvérisateur	299,480
flûte à champagne	335,456
forme à gateaux	544,552-553
fouet	537
fourchette à salade	250,514,517,556
fourchette à viande	515,518-519
fourchette de service	515
frisette	62,533,541
<b>G</b>	
gants de boulanger	554
GN bac	30,25,49,139,251,414-416,419-425
GN bac acier inoxydable	139,414-416
GN bol mélamine	175,179,185,213
GN Chafing Dish	391,393-394,396,398-400
GN cloche	139,188,366,369,379,562-564
GN corbeille	26,358-361,362-366,369,378,380
GN corbeille métal	378,380

GN corbeille polypropylène	358-366,369	pichet à lait	329,490,492	pot	76-78	support	17,62,67,73,92-95,98,99,102,103, 106,215,228,241,293,295,301,344,347, 541,559
GN couvercle	251,417-419,421,424	pichet gradué	542-543	pot à épices	309-310,540	support à bretzel ou à saucissons	62
GN égouttoir	418,421	pichet rafraîchisseur	124-125	pot à sauce acier inox	71	support à cornets	559
GN grille	423	pied pour seau à champagne / vin	445	pot à sauce mélamine	71	support cloche	45
GN planche de service	503	pied pour seau à vin	445	pot à sauce porcelaine	71	support multiple acier inox	75
GN plateau	25,30,52,138-139, 174,176,180,185, 188,190,192,197,198,216,217,218-219, 227,235,237-238,423,247	pilon muddler	470	pot de moutarde	296	<b>T</b>	
GN plateau acier inox	138-139,247	pince	479,521-529	pot verseur universel	490,329	tamis	472,492,538,539
GN plateau ardoise naturelle	16,30,157	pince à apéritif	524	poubelle à pédale	510	tamis cocktail	472,539
GN plateau buffet acier inox	31-34	pince à asperges	526	poubelle de table	354-355	tapis antidérapant	18,454
GN plateau mélamine	30,174,176,180, 185,188,190,192,197,198,216,217, 218-219,227,235,237-238	pince à dresser	479,529	présentoir à assiettes	60-62,106,278	tapis de bar	474
GN plateau party	150	pince à gâteaux	525-528	présentoir	320	tapis égouttoir	474
GN plateau porcelaine	25,423	pince à glaçons	479,523	présentoir à gâteaux	147,153-154, 160,240,361	tasse à café	266,497
GN présentoir buffet	17,228,366	pince à homard	537	présentoir à sandwiches	41	tasse à cappuccino	137,333,495
GN présentoir buffet en escalier	108-109	pince à salade	25,521,524-527	présentoir buffet	29,43,59,106,366,387, 17,54-56,67,73,93-94,95,99,102,228,241, 43,106,366,387	tasse à espresso	136,332,496
GN range couverts	23,90-91 362,428-429	pince à spaghetti	521,523-526	présentoir buffet acier inox	228,241	tasse à remuer	543
GN support buffet	27	pince universelle	526-529	présentoir buffet bois	54-56,67,95,99,102	tasse réutilisable	497
gobelet	113,273,460-466, 493,497,459	pince presse citron	493	présentoir buffet en escalier	104-105,108-109	tasse To-Go	497
gobelet à apéritif	262-264	pique-bons	558	présentoir buffet froid	20,31-40,126,156	théière ASIA	132,282,486
gobelets	457-459,114-115,463,466	pissette p. liqueurs	480	présentoir buffet froid acier inox	31	thermomètre	489
gourde	121,498-499	planche à découper	25,44,68,70,473	présentoir buffet métal	17,73,93-94,98	tire-bouchons	482,483
gravier thermique	405	planche à découper buffet	72-74,124	presse citron	484,551	tube de service	269
<b>H</b>		planche de service	162-169,171,281-288	<b>R</b>		tube pour glaçons	110,124-125,454
housse isotherme	453	plaque à induction	85,390-397,403-404	rack porte-verres	465	<b>V</b>	
<b>J</b>		plaque à pâtisserie	143, 545,361,154, 423	rack pour planches à découper	559	vase soliflor	342
jeu de cuillère à mesure	528	plat à gâteau acier inox	147,154	rafraîchisseur	483	verre à vin	335,456
<b>L</b>		plat à gâteau bois	154	rafraîchisseur de bouteilles	53,71,126,128, 256,443-444,446-447,449-452, 460,483	verre mélangeur	480
lampe de table	336-341,436-441	plat à gâteau mélamine	153,240	rafraîchisseur de caviar	149	verres gourmet	277
louche	514,516,518,519,521	plat à sauter	258-261	ramasse-miettes	315,505	verseurs continus	481
louche de service	517	plat ardoise naturelle	16,30-31,63,149, 156-161,165-166, 284,288-289,304	ramequin	47,205,243-246,257,270-271	vitrine de buffet	32-34,41
<b>M</b>		plateau	19,24,25,30,45,49,52,54,55, 60-66, 68,70,96,138-147,143-145, 148,149,151,152,158,161,163,174,176, 178,180, 182,185,188,189,190,191, 192,197,198,199,200,207,210,214,216, 217,218,219,220,221,224,225,227,230, 232,233,235,237,238,241,247,256,282, 283,286,289,290,292,316,329,361,423, 425,492,500-505	ramasse-miettes	315,505	vitrine de buffet acier inox	32-34
mandoline	541	plateau acier inox	24,25,138-147,149, 247,256,292,316, 500,501,502,505	range couverts	23,89-91,350-355, 362,367,381,428-430	<b>W</b>	
marmite	401	plateau bois	24,45,65,68,96,148,163,282, 283,286,290,329,492	réceptif à pâte	432,554	Weck-bouteilles	274-278,289
marmite avec couvercle	409-410,81-82	plateau feuille mélamine	203,222,239,248	réceptif de table	89-91,350-355,432,473		
marmite petite de servir	260,261,149	plateau mélamine	25,30,65,68, 70,145,151,158,174,176,178,180,182,185, 188,189,190,191,192,197,198,199,200, 207,210,216,217,218,219,220,221,224,22, 5,227,230,232,233,235,237,238, 241,247,289,500,502,503	repose-cuillère	431		
marqueur à la craie liquide	17,28,344, 346,386	plateau party	150	réceptif bain-marie	541		
mesure jigger	468-469	plateau self-service et snacks	152,504	réceptif à pâte et boules à pizza	432,554		
Moscow Mule gobelet	460-462	plateau sous-verre acier inox	316	résistance	18,85,129,398-399,403,404,413		
moule à boule ronde simple	530	plateau sous-verre mélamine	112	<b>S</b>			
moule à glaçons	478	plateau sushi mélamine	180,182,207	samovar	134,412,485		
moule à glaçons en boules	478	plateaux réfrigérés	24,31,36	saucière	314,315		
moule à pizza	552-553	plucheur droitier/gaucher	531,532	saupoudreuse à épices	310		
moules à flan	545	pochette à serviettes	325,326	seau	263,433,476-477,543		
moulin à poivre	301-310	pochette couverts	325,326	seau à champagne	127,442-444, 446-447, 448,449		
moulin à sel	301-310	podium	17,18,123	seau à glaçons	26,476		
multibox	133	poêle en fonte	268	seau à glaçons isothermique	443,476-477		
<b>N</b>		pompe de dosage	550	seau à vin	127,442-444,448-449		
organisateur bar caddy	474	pont thermique	51,53,406	service à fondue	317,407		
<b>P</b>		porcelaine	84,136-137,332-333, 394,397,402,494-495	service à parmesan	300-301		
pailles	475	porte verres à bière	151,503	service à punch	317,407		
panier à œufs	361	porte-addition	316,505	set apéritif	294-302,308		
panier en corde au crochet	372	porte-bols	106	set de service	183		
panier pour le service sur table	262	porte-bougies anti-vent	342	set de table	318-328		
panneau d'avertissement	550,575	porte-bouteille à vin	453	set rolltop	16,149		
papier alimentaire	169,143,159, 264,282,292,500	porte-cartes	343-349	set thermo	37		
pare-haleine	17,42,43,62	porte-cartes de table	343-349	shaker	463,466,467		
passoire	538-540	porte-clés avec câble à enroulement	483	snackbox	269,282		
peleur	531	porte-couverts	86-88	sonnette	505		
pelle	287,477,547,553,556,557	pose-cuillère	250,431	soucoupes ardoise naturelle	159,289,304		
pelle à farine	547			soucoupes liège	114-115		
pelle à gâteau	515,517			sous-tasse	112,136-137,332-333,594-595		
pelle à glaçons	477			spatule	516,519-520,534-535		
pelle à pizza	553			spatule à pâte	545		
petits chevaux de buffet	113,117,344-349			spatule coudée spéciale grill	536		
pichet	117,122-125,129-134,263, 122, 124-126,412,453,485-489,492			spatule pâtisseries	169		
pichet à café	489			station de panure	18,85,403		
pichet à eau	122-125			station de charge	340-341,440-441		
pichet à jus de fruit	122-125,247			station de panure	551		
				station pain	68		
				stylo	346		
				sucrier	330-331,491-492		
				superbox	28-30,386-387		





# Buffet & Display

VALO.....	14
BRIDGE.....	20
FRAMES.....	24
SUPERBOX.....	28
COOLING DISPLAYS.....	31
BUFFET GUARDS.....	42
FRIENDLY.....	46
FROSTFIRE.....	50
BUFFET DISPLAY.....	56
ETAGERES.....	60
CUTTING BOARDS.....	68
MULTI RACKS.....	75
JARS.....	76
SPHERE.....	79
5 STARS.....	80
NAPKIN HOLDERS.....	86
CUTLERY BOXES.....	89
BUFFET STANDS.....	92
MANGO.....	96
CEREAL DISPENSERS.....	100
BEVERAGE DISPENSERS.....	110
CARAFES.....	122
BEVERAGE BOWLS.....	126
VACUUM JUGS.....	130
TEAPOTS.....	132
TRAYS   STAINLESS STEEL.....	138
FAST FOOD TRAYS.....	152
CAKE STANDS.....	153
SUPER DOME.....	155
SERVING BOARDS   NATURAL.....	156
SLATE SERVING BOARDS   WOOD.....	162

**NEW** VALO



Auf Gastronom-Größen basierende, stapelbare Boxen und Tablett bilden das Herzstück des innovativen und erweiterbaren Buffetsystems, das zahlreiche Kombinationsmöglichkeiten nicht nur innerhalb des VALO Sortiments zulässt, sondern auch mit vielen weiteren APS Produkten. Geeignet für die vielseitige Speisenpräsentation ist VALO somit ein universelles System, das mit seinem umfangreichen und multifunktionalen Zubehörsortiment Lösungen für alle Anforderungen bietet.

Stackable boxes and trays based on the gastronorm sizes form the centrepiece of the innovative and expandable buffet system, which allows numerous possible combinations not only within the VALO range, but also with many other APS products. Suitable for versatile food presentation, VALO is thus a universal system that offers solutions for all requirements with its extensive and multifunctional range of accessories.

Las cajas y bandejas apilables basadas en tamaños gastronorm forman el núcleo del innovador y ampliable sistema de buffet, que permite numerosas posibilidades de combinación no sólo dentro de la gama VALO, sino también con muchos otros productos APS. Adecuado para la presentación versátil de fiambresas, VALO es, por tanto, un sistema universal que ofrece soluciones para todos los requisitos gracias a su amplia y multifuncional gama de accesorios.

Des boîtes et des plateaux empilables, basés sur les dimensions gastronorm, constituent le cœur de ce système de buffet innovant et extensible, qui permet de nombreuses combinaisons non seulement au sein de la gamme VALO, mais aussi avec de nombreux autres produits APS. VALO est donc un système universel qui offre des solutions à toutes les exigences grâce à sa vaste gamme d'accessoires multifonctionnels.



Kombinierbar mit VALO Schieferplatten und vielen anderen Komponenten in Gastronom-Größen.

Puede combinarse con las bandejas de pizarra VALO y muchos otros componentes en tamaños Gastronom.

NEW



14000



14001



14002

**GN 1/1 Holzbox**

GN 1/1 woodbox  
GN 1/1 caja madera  
GN 1/1 base bois



Eichenholz (geölt) / oak wood (oiled) / madera de roble (aceitada) / chêne (huilé)

	cm	↑ cm	GN	€
14000	53 x 32,5	4,5	1/1	69,00
14001	53 x 32,5	8,5	1/1	84,00
14002	53 x 32,5	16,5	1/1	124,00

NEW



14003



14004



14005

**GN 1/2 Holzbox**

GN 1/2 woodbox  
GN 1/2 caja madera  
GN 1/2 base bois



Eichenholz (geölt) / oak wood (oiled) / madera de roble (aceitada) / chêne (huilé)

	cm	↑ cm	GN	€
14003	32,5 x 26,5	4,5	1/2	49,00
14004	32,5 x 26,5	8,5	1/2	60,00
14005	32,5 x 26,5	16,5	1/2	84,00

NEW



14006



14007

**GN 1/3 Holzbox**

GN 1/3 woodbox  
GN 1/3 caja madera  
GN 1/3 base bois



Eichenholz (geölt) / oak wood (oiled) / madera de roble (aceitada) / chêne (huilé)

	cm	↑ cm	GN	€
14006	32,5 x 17,5	4,5	1/3	42,00
14007	32,5 x 17,5	8,5	1/3	49,00

NEW



14008



14009

**GN 2/4 Holzbox**

GN 2/4 woodbox  
GN 2/4 caja madera  
GN 2/4 base bois



Eichenholz (geölt) / oak wood (oiled) / madera de roble (aceitada) / chêne (huilé)

	cm	↑ cm	GN	€
14008	53 x 16,2	4,5	2/4	54,00
14009	53 x 16,2	8,5	2/4	64,00



**GN Naturschieferplatte**

GN natural slate tray  
GN bandeja de pizarra natural  
GN plat ardoise naturelle



**Schieferplatte mit möbelschonenden Füßchen**

slate top with furniture-friendly feet  
encimera de pizarra con patas aptas para muebles  
plateau en ardoise avec pieds qui protègent les meubles

	cm	✦ mm	GN	€
1001	53 x 32,5	6 - 9	1/1	15,80
1002	53 x 16,2	6 - 9	2/4	6,50
1003	32,5 x 26,5	6 - 9	1/2	8,80
1004	32,5 x 17,6	6 - 9	1/3	5,40



**Einsatz für GN 1/1 Holzbox**

insert for GN 1/1 woodbox  
separador para GN 1/1 caja madera  
insert pour GN 1/1 base bois



**Einsatz mit Fächern 9,5 x 9,5 cm**

insert with compartments 9.5 x 9.5 cm  
bandeja con compartimentos 9,5 x 9,5 cm  
insert avec compartiments 9,5 x 9,5 cm

	cm	↑ cm	fits to	€
14021	50,5 x 30	6	14001	34,00



**Einsatz für GN 1/2 Holzbox, 2er Set**

insert for GN 1/2 woodbox, 2 pcs  
separador para GN 1/2 caja madera, set de 2  
insert pour GN 1/2 base bois, set de 2



**Einsatz mit drei Fächern**

insert with 3 compartments  
bandeja con 3 compartimentos  
insert avec 3 compartiments

	cm	↑ cm	fits to	€
14022	24 x 10,5	6	14004	19,00



**GN Einsatz**

GN insert  
GN bandeja  
GN bac supérieur



**Einsatz passend zu Artikel 14002**

insert suitable for article 14002  
inserto adecuado para el artículo 14002  
insert adapté à l'article 14002

	cm	↑ cm	fits to	€
14036	51,5 x 31	14	14002	32,00
14037	31 x 25	13	14005	24,00







NEW



14030



14031



14032



14033



14034



14035

### GN Buffetständer

GN buffet stand + Zubehör

GN soporte para buffet

GN présentoir buffet



- Multifunktionaler stapelbarer Buffetständer aus pulverbeschichtetem Metall
- Stecktafel
- Eckverbindung
- Podest und Schild
- Hygieneschutz

- multifunctional stackable buffet stand made of powder-coated metal
- pegboard
- corner connection
- pedestal and shield
- hygienic protection

- soporte multifuncional apilable para bufé fabricado en metal con recubrimiento en polvo
- tablero de anuncios
- conexión de esquina
- pedestal y escudo
- protección higiénica

- support de buffet multifonctionnel empilable en métal revêtu par poudre
- panneau d'affichage
- raccord d'angle
- plateforme et bouclier
- protection hygiénique

	cm	↑ cm	€
14030	57 x 37	28,5	120,00
14031	57 x 1	19,5	32,00
14032	39 x 39	3	39,00
14033	∅ 25	20,5	28,00
14034	∅ 25	33	28,00
14035	60,5 x 36,5	33,5	108,00

### Kreide-Marker, Stärke 2 mm, 2er Set

chalk marker, 2 pcs.

rotulador de tiza, set de 2

marqueur a la craie liquide, set de 2



	∅ cm	↑ cm	Farbe / Colour	pcs.	€ / set
71490	1	13		2	6,20



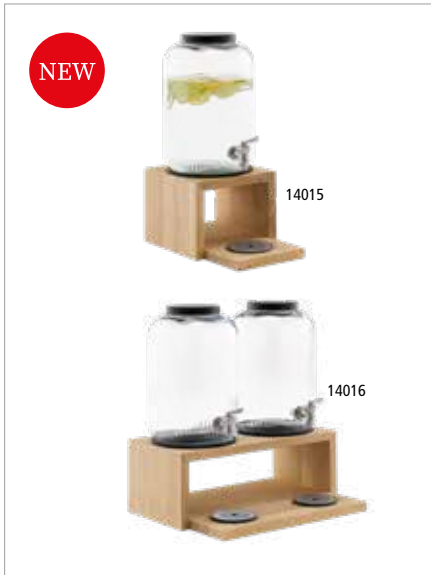

**Getränkespender**

beverage dispenser  
dispensador de bebidas  
distributeur de boissons



**Eichenholz (wasserfest lackiert), Zapfhahn aus Edelstahl, Untersetzer aus Melamin, Bodenplatte (Gläsertablett) herausnehmbar**

oak wood (waterproof lacquered), Stainless steel tap, melamine coaster, removeable base plate  
madera de roble (lacado impermeable), grifo de acero inoxidable, posavasos de melamina, placa base desmontable  
bois de chêne (vernis imperméable), binet en acier inoxydable, dessous de verre en mélamine, plaque de fond amovible

	cm	↑ cm	ltr.	€
14015	21 x 21	46,5	7	240,00
14016	43,5 x 21	46,5	2 x 7	390,00

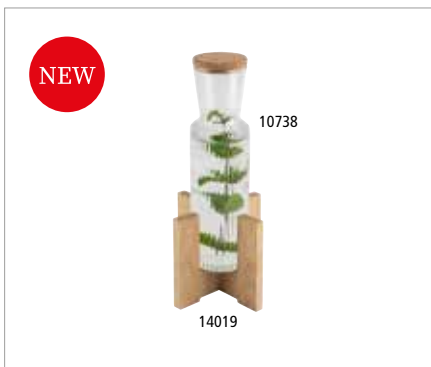

**Podest für Glaskaraffe**

podest for glass carafe  
pedestal para jarra de vidrio  
podium pour pichet en verre



**Eichenholz (wasserfest lackiert)**  
oak wood (waterproof lacquered)  
madera de roble (lacado impermeable)  
bois de chêne (vernis imperméable)

	cm	↑ cm	fits to	€
14019	15 x 15	12	10738, 10739	14,00



**Antirutschmatte**

anti-slip mat  
alfombrilla antideslizante  
tapis antidérapant



**Passend für GN 1/1, GN 1/2, GN 2/4**  
suitable for GN 1/1, GN 1/2, GN 2/4  
decuado para GN 1/1, GN 1/2, GN 2/4  
convient pour GN 1/1, GN 1/2, GN 2/4

	fits to	€
14038	GN 1/1	10,00
14039	GN 1/2	8,00
14040	GN 2/4	8,00



**Induktionsstation, 2-tlg. Set**

Induction station, 2-piece set  
Estación de inducción, juego de 2 piezas  
Station à induction, set de 2 pièces



**Set, bestehend aus Induktionkochplatte 2000 Watt (no. 12285), inklusive Kabel-Fernbedienung, Leistung in Stufen regelbar, Rahmen aus Eichenholz (wasserfest lackiert) (no. 14051)**

set consists of induction hotplate 2000 Watt, cable remote control, power adjustable in steps, frame made of oak (waterproof lacquered)  
set, compuesto por placa de inducción 2000 Watt (no. 12285), incluye mando a distancia por cable, potencia regulable en pasos, madera de roble (lacado impermeable)  
set, composé d'une plaque de cuisson à induction 2000 watts (no. 12285), télécommande filaire incluse, puissance réglable par paliers, bois de chêne (vernis imperméable)

	cm	↑ cm		€
14050	39 x 39	10	2000 W	264,00

NEW



14010



14011

**Etagère, 2-stufig**

2-tier tray  
bandeja 2 alturas  
étagère carré 2 hauteurs

**Gestell aus Eichenholz (geölt)**

oak wood frame (oiled)

marco de madera de roble (aceitada)

structure en bois du chêne (huilé)



	cm	↑ cm	fits to	€
14010	35 x 26,5	44,5	GN 1/2, 1/3	160,00
14011	55,5 x 26,5	44,5	GN 2/4	184,00

NEW



14012

**Etagère, 3-stufig**

3-tier tray  
bandeja 3 alturas  
étagère carré 3 hauteurs

**Gestell aus Eichenholz (geölt)**

oak wood frame (oiled)

marco de madera de roble (aceitada)

structure en bois du chêne (huilé)



	cm	↑ cm	fits to	€
14012	55,5 x 32,5	64	GN 1/1, 2/4	240,00

NEW



14013



14014

**Etagère, 2+3-stufig, rund**

2+3-tier tray, round  
bandeja 2+3 alturas, en torno a  
étagère carré 2+3 hauteurs, rond

**Gestell aus Eichenholz (geölt)**

oak wood frame (oiled)

marco de madera de roble (aceitada)

structure en bois du chêne (huilé)



	Ø cm	↑ cm	€
14013	30	28	66,00
14014	30	42	84,00



# BRIDGE

Mit hohem Anspruch an Design und Funktionalität haben wir das Buffet-System „Bridge“ für Sie entwickelt. Die in den Holzoberflächen Ahorn und Wenge erhältlichen Artikel sind in ihren Höhen und ihren Volumina optimal aufeinander abgestimmt und gewährleisten einen einfachen und sicheren Umgang in Ihrem Gastronomiealltag.

The collection "Bridge" is bringing perfectly coordinated components for an uncomplicated and organized buffet system, finalizing in a unique buffet scenery. All pieces combine perfectly with one another in their variations of sizes and volumes. The wooden items are available in 2 colors, maple or wenge. A simple and safe handling is guaranteed.

Una colección universal para un buffet único: un Sistema funcional y fácil de componer, asociado a la elegancia de su exclusivo diseño. Los elementos se combinan a la perfección entre variaciones de Alturas y volúmenes, realizando sus propuestas y composiciones culinarias y modelando el paisaje del buffet. Las piezas están disponibles en 2 colores, wengué o arce. Manejo sencillo y seguro.

Une collection universelle pour une présentation unique de votre buffet: fonctionnel et facile à composer, ce système est à la fois pratique, simple et spectaculaire par son élégant design. Les différents éléments se marient à la perfection pour construire sans difficulté différentes compositions, variant les hauteurs et les volumes et mettant en valeur vos créations culinaires. Les pièces sont disponibles en deux couleurs, bois wengé ou érable.



## Kühlbox „BRIDGE“ refrigerated buffet display set de buffet refrigerado présentoir buffet froid



Set bestehend aus: 1 Gestell aus Ahorn oder Wenge, 1 Behälter aus Kunststoff, 1 GN1/1 Tablett aus Melamin, 1 Kühllakku, 1 Rolltophaube (fix montiert)

set consists of: 1 base element maple or wenge, 1 plastic insert black, 1 GN1/1 tray melamine, 1 cooler, 1 cover (fixed)

set compuesto por: 1 soporte de madera arce o wengué, 1 cubeta de plástico, 1 bandeja de melamina GN 1/1, 1 acumulador de frío, 1 campana rolltop (fija)

set composé de: 1 support en bois érable ou wengé, 1 bac plastique, 1 plat en mélamine GN 1/1, 1 accumulateur de froid, 1 cloche rolltop (fixe)

	cm	↑ cm	Farbe / Colour	€
13990	63,5 x 42,5	31	ahorn wood	370,00
14990	63,5 x 42,5	31	wenge wood	370,00



2 sizes  
0,50 ltr. / 2,50 ltr.

### Kühlschale „BRIDGE“

cooling bowl  
bol refrigerado  
bol réfrigéré



4-teilig: 1 Gestell aus Ahorn oder Wenge, 1 Behälter aus Edelstahl,  
1 Schale aus Melamin (Ø 14 cm o. 23 cm), 1 Kühlakku

4 pcs.: 1 base element maple or wenge, 1 bowl stainless steel,  
1 bowl melamine (Ø 14 or 23 cm), 1 cooler

set de 4: 1 soporte de madera arce o wengué, 1 cuenco  
de acero inoxidable, 1 cuenco de melamina (Ø 14 cm o 23 cm), 1 acumulador de frío

set de 4: 1 support en bois érable ou wengé, 1 bol en acier inox, 1 bol en mélamine  
(Ø 14 cm ou 23 cm), 1 accumulateur de froid

	cm	↑ cm	ltr.	Farbe / Colour	€
13980	18,5 x 18,5	10	0,5		59,00
13981	27,5 x 27,5	14	2,5		114,00

	cm	↑ cm	ltr.	Farbe / Colour	€
14980	18,5 x 18,5	10	0,5		59,00
14981	27,5 x 27,5	14	2,5		114,00



### Edelstahlschale „BRIDGE“

stainless steel bowl  
cuenco acero inoxidable  
bol acier inox



	Ø cm	↑ cm		€
30050	14	8,5		26,00
30052	23	13,5		58,00



### Schale „CASUAL MAXI“

bowl  
cuenco  
bol



	Ø cm	↑ cm	ltr.	Farbe / Colour	€
83700	14	6,5	0,5		4,90
83702	23	10,5	2,5		11,80

	Ø cm	↑ cm	ltr.	Farbe / Colour	€
83701	14	6,5	0,5		4,90
83703	23	10,5	2,5		11,80



### Kühlakku

cooler  
acumulador de frío  
accumulateur de froid



	Ø cm	↑ cm		€
10661	10,5	2,0		3,40
10777	15,0	2,5		5,40



Milchdispenser „BRIDGE“

milk dispenser  
dispensador de leche  
distributeur à lait



Edelstahl Dispenser mit 1 Kühlakku im Standfuß inklusive touchless adapter

stainless steel dispenser with 1 cooling element in stand including touchless adapter  
dispensador de acero inoxidable con 1 acumulador de frío en la base y con adaptador sin contacto para grifo  
distributeur en acier inox avec 1 accumulateur de froid dans le socle et avec adaptateur sans contact manuel

	cm	↑ cm	ltr.	Farbe / Colour		€
10836	31 x 20	39	3		Ahorn / maple	279,00
10838	39 x 22	45	5		Ahorn / maple	444,00



Milchdispenser „BRIDGE“

milk dispenser  
dispensador de leche  
distributeur à lait



Edelstahl Dispenser mit 1 Kühlakku im Standfuß inklusive touchless adapter

stainless steel dispenser with 1 cooling element in stand including touchless adapter  
dispensador de acero inoxidable con 1 acumulador de frío en la base y con adaptador sin contacto para grifo  
distributeur en acier inox avec 1 accumulateur de froid dans le socle et avec adaptateur sans contact manuel

	cm	↑ cm	ltr.	Farbe / Colour		€
10837	31 x 20	39	3		Buche / beech	279,00
10839	39 x 22	45	5		Buche / beech	444,00



Saftdispenser „BRIDGE“

juice dispenser  
dispensador de zumo  
distributeur à jus



Kühlung durch 2 Kühlakkus von oben und unten

cooling with 2 cooling elements from the top and base  
2 acumuladores de frío: 1 en la base y 1 en la tapa  
2 accumulateurs de froid: 1 dans le couvercle et 1 dans le socle

	cm	↑ cm	ltr.	Farbe / Colour		€
10870	31,0 x 20	42	4		Ahorn / maple	239,00
10871	35,5 x 22	50	6		Ahorn / maple	279,00



inklusive 3 Magnetschilder: ORANGE, APPLE, GRAPEFRUIT  
including 3 magnetic signs: ORANGE, APPLE, GRAPEFRUIT



Saftdispenser „BRIDGE“

juice dispenser  
dispensador de zumo  
distributeur à jus



Kühlung durch 2 Kühlakkus von oben und unten

cooling with 2 cooling elements from the top and base  
2 acumuladores de frío: 1 en la base y 1 en la tapa  
2 accumulateurs de froid: 1 dans le couvercle et 1 dans le socle

	cm	↑ cm	ltr.	Farbe / Colour		€
10872	31,0 x 20	42	4		Wenge / wenge	239,00
10873	35,5 x 22	50	6		Wenge / wenge	279,00



inklusive 3 Magnetschilder: ORANGE, APPLE, GRAPEFRUIT  
including 3 magnetic signs: ORANGE, APPLE, GRAPEFRUIT



4,5 ltr.

**Cerealienspender „BRIDGE“**

cereal dispenser  
dispensador de cereales  
distributeur de céréales



**Behälter herausnehmbar, „Feierabend-Deckel“ für das aromadichte Lagern, Portionieren durch einfaches Drehen**

removable canister, special lid to keep the cereals fresh, easy to use, rotate the button to get the muesli

contenedor extraíble, tapa especial para mantener los cereales frescos, fácil de usar, se gira el pomo para servir los cereales

réceptif amovible, couvercle spécial pour conserver les céréales, usage facile en tournant le bouton

	cm	↑ cm	ltr.	Farbe / Colour		€
13987	21 x 20	55,5	4,5		Ahorn / maple	109,00



4,5 ltr.

**Cerealienspender „BRIDGE“**

cereal dispenser  
dispensador de cereales  
distributeur de céréales



**Behälter herausnehmbar, „Feierabend-Deckel“ für das aromadichte Lagern, Portionieren durch einfaches Drehen**

removable canister, special lid to keep the cereals fresh, easy to use, rotate the button to get the muesli

contenedor movible, tapa especial para mantener los cereales frescos, fácil de usar, se gira el pomo para servir los cereales

réceptif amovible, couvercle spécial pour conserver les céréales, usage facile en tournant le bouton

	cm	↑ cm	ltr.	Farbe / Colour		€
14987	21 x 20	55,5	4,5		Buche / beech	109,00

**Besteckbehälter „BRIDGE“**

cutlery organizer  
cajón para cubiertos  
bac à couverts



**2 teiliges Set: 1 Gestell, 1 Besteckbehälter (Nr. 11955), herausnehmbar**

2 pcs.: 1 base element, 1 removable plastic container (item 11955)

set de 2: 1 soporte, 1 cajón para cubiertos (ref. 11955) extraíble

set de 2: 1 support, 1 bac à couverts (réf. 11955) amovible

	cm	↑ cm	Farbe / Colour		€
13995	57,5 x 37	12		Ahorn / maple	88,00

**Besteckbehälter „BRIDGE“**

cutlery organizer  
cajón para cubiertos  
bac à couverts



**2 teiliges Set: 1 Gestell, 1 Besteckbehälter (Nr. 11955), herausnehmbar**

2 pcs.: 1 base element, 1 removable plastic container (item 11955)

set de 2: 1 soporte, 1 cajón para cubiertos (ref. 11955) extraíble

set de 2: 1 support, 1 bac à couverts (réf. 11955) amovible

	cm	↑ cm	Farbe / Colour		€
14995	57,7 x 37	12		Buche / beech	88,00

# FRAMES



Die reduzierte, archetypische Formsprache von FRAMES nimmt sich elegant zurück und lässt damit viel Raum für die Inszenierung der Buffet-Speisen. Ein scheinbarer Widerspruch löst sich auf: das Design ist zeitgemäß und zeitlos zugleich.

Design in detail – The classic minimalist visual style of FRAMES is elegantly understated, leaving plenty of potential for creating appealing buffet arrangements. Its design transcends what at first seems to be an irreconcilable paradox, being at once both timeless and highly contemporary.

Diseño en detalle - El estilo visual clásico y minimalista de FRAMES es elegantemente sobrio, dejando mucho potencial para crear atractivas composiciones para el buffet. Su diseño supera lo que a primera vista parece una paradoja irreconciliable, siendo a la vez intemporal y muy contemporáneo.

Le design dans le détail - Le style visuel minimaliste classique de FRAMES est élégamment discret, laissant beaucoup de potentiel pour créer des arrangements de buffet attrayants. Son design transcende ce qui semble à première vue être un paradoxe irréconciliable, étant à la fois intemporel et très contemporain.



## Kühltablets SET 1 „FRAMES“

cooling plates  
bandejas refrigeradas  
plateaux réfrigérés



GN 1/1 Basiselement, GN 1/1 Edelstahl Tablett 18/10, Kühlakku  
GN 1/1 base element, GN 1/1 stainless steel platter 18/10, cooler  
elemento básico GN 1/1, bandeja GN 1/1 de acero inoxidable 18/10, acumulador de frío  
élément de base GN 1/1, plateau GN 1/1 en acier inox 18/10, accumulateur de froid

	cm	↑ cm	GN	Farbe / Colour		€
12940	53 x 32,5	8,5	1/1	stainless steel		246,00
14940	53 x 32,5	8,5	1/1	wenge wood		249,00



## Kühltablets SET 2 „FRAMES“

cooling plates  
bandejas refrigeradas  
plateaux réfrigérés



GN 1/1 Basiselement, GN 1/1 Edelstahl Tablett 18/10, Rolltophaube, Kühlakku  
GN 1/1 base element, GN 1/1 stainless steel platter, rolltop cover, cooler  
elemento básico GN 1/1, bandeja GN 1/1 de acero inoxidable 18/10, campana rolltop, acumulador de frío  
élément de base GN 1/1, plateau GN 1/1 en acier inox 18/10, cloche rolltop, accumulateur de froid

	cm	↑ cm	GN	Farbe / Colour		€
12941	53 x 32,5	27,5	1/1	stainless steel		310,00
14941	53 x 32,5	27,5	1/1	wenge wood		314,00





**Schneidebrett „FRAMES“**

cutting board  
tabla de cortar  
planche à découper



	cm	↑ cm	GN	€
17910	53 x 32,5	2,5	1/1	63,00



**GN Tablett „FRAMES“**

GN tray  
GN bandeja  
GN plateau



	cm	↑ cm	GN	€
82355	53,0 x 32,5	2	1/1	46,00
82356	32,5 x 26,5	2	1/2	26,00
82357	32,5 x 17,6	2	1/3	22,00



**GN Edelstahl Tablett „FRAMES“**

GN stainless steel platter  
GN bandeja acero inoxidable  
GN plateau acier inox



	cm	↑ cm	GN	€
11119	53,0 x 32,5	2	1/1	33,00



**GN Tablett „FRAMES“**

GN tray  
GN bandeja  
GN plateau



	cm	↑ cm	GN	€
84046	53,0 x 32,5	2	1/1	33,00
84047	32,5 x 26,5	2	1/2	18,40
84048	32,5 x 17,6	2	1/3	12,60



**GN Wanne „FRAMES“**

GN tray  
GN bandeja  
GN plateau



	cm	↑ cm	GN	€
17922	53 x 32,5	8	1/1	60,00

## FRAMES



### Korb „GN LINE“

GN basket

GN cesta

GN corbeille



**stabile Ausführung mit Edelstahldraht im Rand zur Stabilisierung**

very solid with stainless steel wire frame to stabilize the basket

muy resistente con alambre de acero inoxidable en el borde para la estabilización

très résistante avec fil d'acier inox dans le bord pour la stabilisation

	cm	↑ cm	GN	€
40291	53,0 x 32,5	6,5	1/1	26,00
40290	32,5 x 26,5	6,5	1/2	15,80
40293	53,0 x 32,5	10,0	1/1	31,40
40292	32,5 x 26,5	10,0	1/2	18,80



### Buffetkorb „ECONOMIC“

basket

cesta

corbeille



**Polyrattan, mit Haubenschiene (ohne Haube)**

polyrattan, with frame to fix the cover (without cover)

polyrattan, con fijación para campana (sin campana)

polyrattan, avec fixation pour la cloche (sans cloche)

	cm	↑ cm	€
40294	56,5 x 36,0	10	33,00



### Buffetkorb „ECONOMIC“

buffet basket

cesta de buffet

corbeille de buffet



**Polyrattan, mit Haubenschiene (ohne Haube)**

polyrattan, with frame to fix the cover (without cover)

polyrattan, con fijación para campana (sin campana)

polyrattan, avec fixation pour la cloche (sans cloche)

	Ø cm	↑ cm	€
40295	40	12,5	23,00



### Rolltophaube

rolltop cover

campana abatible

cloche basculante



	Ø cm	↑ cm	€
18389	38	20	23,00



### Eisbox „FRAMES“

ice box

bandeja para hielo

caisse à glaçons



**3-teilig: 1 Basiselement Wenge + 1 Polystyrolwanne + 1 Tropfgitter**

3 pcs. set: 1 box wenge + 1 plastic deep tray + 1 drainer plate

set de 3: 1 cajón color wengué + 1 cubeta plástico + 1 rejilla

set de 3: 1 caisson couleur wengé + 1 bac plastique + 1 plaque perforée

	cm	↑ cm	GN	Farbe / Colour	€
14970	53 x 32,5	12,5	1/1		189,00



vielseitig einsetzbar für alle GN 1/1 Artikel

11008

14953

**Gestell für GN 1/1 „FRAMES“**

serving stand GN 1/1  
soporte para GN 1/1  
support pour GN 1/1

**Buche massiv, Wenge**  
solid beech, colour wenge  
haya maciza, color wengué  
hêtre massif, couleur wengé



	cm	↑ cm	Farbe / Colour	€
14953	57,5 x 27,5	22		90,00



84047  
GN 1/2

84047  
GN 1/2

passendes Kühltablett Set



14956

14953

passende Besteck / Universal-Box GN 1/1



14954  
Einsatz / insert

**Besteck- / Universal-Box, 2-teilig „FRAMES“**

cutlery tray, 2 pcs.  
cubertero o cajón multi-usos, set de 2  
caisson à couverts ou multi-usages, set de 2

**Buche massiv, Wenge, 4 Fächer, inklusive herausnehmbaren Einsatz**  
solid beech, colour wenge, 4 compartments, including removable insert  
haya maciza, color wengué, 4 compartimentos, con separador extraíble  
hêtre massif, couleur wengé, 4 compartiments, avec insert amovible



	cm	↑ cm	GN	Farbe / Colour	€
14956	53 x 32,5	11	1/1		184,00

**Einsatz für GN 1/1 „FRAMES“ / insert for GN1/1 / separador para GN1/1 / insert pour GN1/1**

	cm	↑ cm	Farbe / Colour	€
14954	48,5 x 28	8		44,00



**GN 1/1 Rolltophaube**

GN 1/1 rolltop cover  
GN 1/1 campana abatible  
GN 1/1 cloche basculante

**verchromter Zinkdruckguss-Griff**  
chrome plated metal handle  
mango cromado de fundición a presión de zinc  
poignée en zinc moulé sous pression chromé



	cm	↑ cm	GN	€
11018	53 x 32,5	17	1/1	64,00



**GN 1/1 Rolltophaube**

GN 1/1 rolltop cover  
GN 1/1 campana abatible  
GN 1/1 cloche basculante

**patentiert, passend für GN-Behälter, -Tablets, etc., leichtgängig auf- und zuklappbar 90°**  
patented, suitable for GN containers, trays, etc., solid quality, 90° opening  
patentada, para contenedores, bandejas GN, apertura 90°  
breveté, pour bacs, plateaux GN, ouverture 90°



	cm	↑ cm	GN	€
11008	53 x 32,5	17	1/1	64,00



Die stapelbaren Wendeboxen lassen sich rutschfest stapeln und mit flachen GN Platten verbinden und einzeln nutzen. Individuell können Buffet-landschaften gebaut werden.

The stackable and non-slip reversible boxes can be connected to flat GN trays and can also be used individually. Different and individual buffet sceneries can be built up.

Las cajas girables y apilables son antideslizantes y se pueden conectar con bandejas planas GN o utilizar individualmente. Se pueden construir diferentes paisajes de buffet muy individuales.

Les boîtes de tournage empilables sont antiglissantes et peuvent être connectées avec des plateaux plats GN ou utilisées individuellement. Des paysages de buffet très personnalisés peuvent être construits.



**Beschriftungsschilder, 2er Set**  
 inscription labels, 2 pcs.  
 étiquettes d'inscription, set de 2  
 etiquetas de inscripción, set de 2



	cm	↑ cm	Farbe / Colour	€/ set
11719	8 x 1,5	5,5	■	8,00



**Kreide-Marker, Stärke 2 mm, 2er Set**  
 chalk marker, 2 pcs.  
 rotulador de tiza, set de 2  
 marqueur a la craie liquide, set de 2



	Ø cm	↑ cm	Farbe / Colour	pcs.	€/ set
71490	1	13	■	2	6,20



**GN 1/1 „SUPERBOX“**



Akazienholz / acacia wood / madera de acacia / bois d'acacia

	cm	↑ cm	GN	Farbe / Colour	€
11620	55,5 x 35,0	10,5	1/1	■	44,00
11626	55,5 x 35,0	10,5	1/1	■	44,00
11721	55,5 x 35,0	20,0	1/1	■	67,00
11723	55,5 x 35,0	20,0	1/1	■	67,00



GN 2/4 „SUPERBOX“

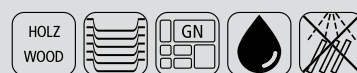

Akazienholz / acacia wood / mader de acacia / bois d'acacia

	cm	↑ cm	Farbe / Colour	€
11623	55,5 x 18,5	10,5		35,00
11629	55,5 x 18,5	10,5		35,00



GN 1/2 „SUPERBOX“

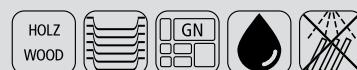

Akazienholz / acacia wood / mader de acacia / bois d'acacia

	cm	↑ cm	GN	Farbe / Colour	€
11621	35,0 x 29,0	10,5	1/2		28,00
11627	35,0 x 29,0	10,5	1/2		28,00
11722	35,0 x 29,0	20,0	1/2		42,50
11724	35,0 x 29,0	20,0	1/2		42,50



GN 1/4 „SUPERBOX“



Akazienholz / acacia wood / mader de acacia / bois d'acacia

	cm	↑ cm	Farbe / Colour	€
11622	29 x 18,5	10,5		22,00
11628	29 x 18,5	10,5		22,00



Buffetgestell

buffet stand  
soporte para buffet  
présentoir buffet



Metall, schwarz, passend für GN Boxen, mit Antrutschfüßchen

metal, black, suitable for GN boxes, with non-slip feet

metal, negro, para cajas GN, con pies antideslizantes

métal, noir, pour boîtes GN, avec pieds antidérapantsw

	cm	↑ cm	suitable for	Farbe / Colour	€
30329 <small>new</small>	29 x 32,5	48	GN 1/2 boxes		42,00
30331	49 x 38,5	48	GN 1/1, GN 1/2 boxes		50,00



Präsentationsmöglichkeit  
presentation example



**GN Tablett „ZERO“**

GN tray  
GN bandeja  
GN plateau



	cm	↑ cm	GN	Farbe / Colour	€
84185	53,0 x 32,5	1,5	1/1		41,40
84186	32,5 x 26,5	1,5	1/2		22,40
84188	26,5 x 16,2	1,5	1/4		12,60
84189	53,0 x 16,2	1,5	2/4		24,60



mit Antirutschfüßchen  
with non-slip feet

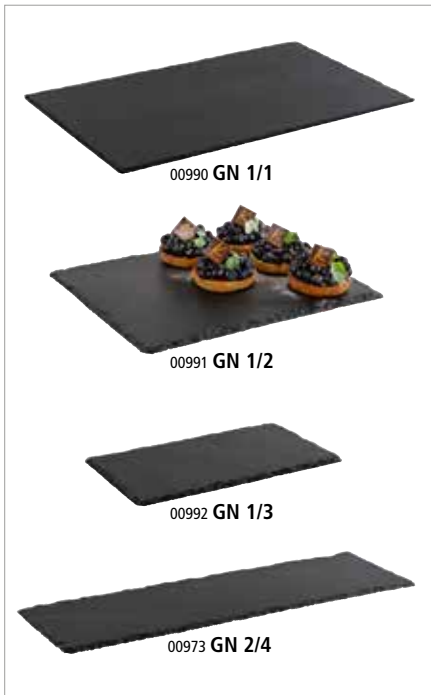

**GN Naturschieferplatten**

GN natural slate tray  
GN bandeja de pizarra natural  
GN plat ardoise naturelle



	cm	✱ mm	GN	€
00990	53,0 x 32,5	6 - 9	1/1	15,80
00991	32,5 x 26,5	6 - 9	1/2	8,80
00993	26,5 x 16,2	6 - 9	1/4	5,00
00973	53,0 x 16,2	6 - 9	2/4	6,50



**GN Einsatz „SUPERBOX“**

GN insert  
GN bandeja  
GN bac supérieur



	cm	↑ cm	GN	fits to	€
11616	53,0 x 32,5	8,5	1/1	11620, 11626	30,00
11617	32,5 x 26,5	8,5	1/2	11621, 11627	25,00





**Kühlbox „SLATE“**  
refrigerated buffet display  
expositor buffet frío  
plateau buffet froid



3-teilig, bestehend aus: 1 Basis aus schwarzem Polystyrol,  
1 Naturschieferplatte, 1 Kühlakku (ohne Haube)

3 pcs., set consists of: 1 base made of black polystyrene, 1 natural slate tray, 1 cooler (without cover)

set de 3 compuesto por: 1 soporte de poliestireno negro, 1 bandeja de pizarra natural, 1 acumulador de frío (sin campana)

set de 3 composé de: 1 support en polystyrène noir, 1 plateau en ardoise naturelle, 1 accumulateur de froid (sans couvercle)

	cm	↑ cm	€
11645	58 x 38	6,5	80,00

**Naturschieferplatte / natural slate tray / bandeja de pizarra natural / plateau ardoise naturelle**

	cm	✱ mm	€
00979	58 x 38	6 - 9	19,00

**Kühlakku / cooler / acumulador de frío / accumulateur de froid**

	cm	↑ cm	€
10782	41 x 21	2,5	16,00

**GN Rolltophaube mit schwarzem Griff / GN rolltop cover with black handle / GN campana rolltop con mango negro / GN cloche rolltop avec poignée noire**

	cm	↑ cm	GN	€
11075	53 x 32,5	19	1/1	62,00



**Kühlbox „TOP FRESH GN 1/1“**  
cooling plate  
bandeja de frío  
présentoir buffet réfrigéré



4-teilig: 1 Kühlbox + 1 Tablett GN 1/1 + 2 Kühlakkus, ohne Haube

4 pcs.: 1 box + 1 tray GN 1/1 + 2 coolers, without cover

set de 4: 1 caja + 1 bandeja GN 1/1 + 2 acumuladores de frío, sin campana

set de 4: 1 caisson + 1 plateau GN 1/1 + 2 accumulateurs de froid, sans cloche

	cm	↑ cm	Farbe / Colour	€
11503	56,5 x 35	6,5	White	104,00
11505	56,5 x 35	6,5	Black	104,00

**GN Rolltophaube mit vergoldetem Kreuzgriff / GN rolltop cover with gold-plated cross handle / GN campana rolltop con asa en cruz dorada / GN cloche rolltop avec manche en croix plaqué or**

	cm	↑ cm	GN	€
11008	53,0 x 32,5	19	1/1 mit vergoldetem Kreuzgriff	62,00

**GN Rolltophaube mit verchromtem Kreuzgriff / GN rolltop cover with chrome-plated cross handle / GN campana rolltop con asa en cruz cromada / GN cloche rolltop avec manche en croix chromée**

	cm	↑ cm	GN	€
11010	53 x 32,5	19	1/1 mit verchromtem Kreuzgriff	62,00

**Kühlakku / cooler / acumulador de frío / accumulateur de froid**

	cm	↑ cm	€
10791	25 x 19	2,5	7,90

**GN Edelstahl-Tablett „PROFI LINE“ / GN tray / GN bandeja / GN plateau**

	cm	↑ cm	GN	€
11100	53 x 32,5	1,5	1/1	31,00

**Kühlakkus halten Ihre Speisen bis zu 6 Stunden kühl**  
cooling system keeps the food cool for up to 6 hours

## COOLING DISPLAYS

**4 tlg.**  
4 pcs.



11546



11075

**Buche, wasserfest lackiert**  
beech wood lacquered



10791

**Kühlakkus halten Ihre Speisen bis zu 6 Stunden kühl**  
cooling system keeps the food cool for up to 6 hours

### Buffetvitrine „TOP FRESH GN 1/1“ refrigerated buffet display expositor buffet frío plateau buffet froid



4-teilig: 1 Box aus Buchenholz mit Kunststoffwanne + 1 Edelstahl-Tablett GN 1/1 + 2 Kühlakkus, ohne Haube

4 pcs.: 1 beech wood box with plastic insert + 1 stainless steel tray GN 1/1 + 2 coolers, without cover

set de 4: 1 caja de madera de haya con bandeja de plástico + 1 bandeja de acero inoxidable GN 1/1 + 2 acumuladores de frío, sin campana

set de 4: 1 boîte en bois de hêtre avec bac en plastique + 1 plateau en acier inox GN 1/1 + 2 accumulateurs de froid, sans cloche

	cm	↑ cm	€
11546	60 x 41	5	189,00

GN Rolltophaube mit schwarzem Griff / GN rolltop cover with black handle / GN campana rolltop con mango negro / GN cloche rolltop avec poignée noir

	cm	↑ cm	GN	€
11075	53 x 32,5	19	1/1	62,00

GN Rolltophaube mit Chromgriff / GN rolltop cover with chrome handle / GN campana rolltop con asa cromada / GN cloche rolltop avec poignée chromée

	cm	↑ cm	GN	€
11010	53 x 32,5	19	1/1	62,00

Kühlakku / cooler / acumulador de frío / accumulateur de froid

	cm	↑ cm	€
10791	25 x 19	2,5	7,90

**12 tlg.**  
12 pcs.



11547

**Buche, wasserfest lackiert**  
beech wood lacquered



10791

**Kühlakkus halten Ihre Speisen bis zu 6 Stunden kühl**  
cooling system keeps the food cool for up to 6 hours

### Buffetvitrine „DOPPELDECKER GN 1/1“ refrigerated buffet display expositor buffet frío plateau buffet froid



12-teilig: 2 Boxen aus Buchenholz mit Kunststoffwanne + 2 Edelstahl-Tablets GN 1/1 + 4 Kühlakkus + 4 verchromte Stangen, ohne Hauben

12 pcs.: 2 beech wood boxes with plastic insert + 2 stainless steel trays GN 1/1 + 4 coolers + 4 chrome-plated bars, without covers

set de 12: 2 cajas de madera de haya con bandeja de plástico + 2 bandejas de acero inoxidable GN 1/1 + 4 acumuladores de frío + 4 barras cromadas, sin campanas

set de 12: 2 boîtes en bois de hêtre avec bac en plastique + 2 plateaux en acier inox GN 1/1 + 4 accumulateurs de froid + 4 barres chromées, sans cloches

	cm	↑ cm	€
11547	60 x 41	36	348,00

GN Rolltophaube mit schwarzem Griff / GN rolltop cover with black handle / GN campana rolltop con asa negra / GN cloche rolltop avec poignée noir

	cm	↑ cm	GN	€
11075	53 x 32,5	19	1/1	62,00

GN Rolltophaube mit Chromgriff / GN rolltop cover with chrome handle / GN campana rolltop con asa cromada / GN cloche rolltop avec poignée chromée

	cm	↑ cm	GN	€
11010	53 x 32,5	19	1/1	62,00

Kühlakku / cooler / acumulador de frío / accumulateur de froid

	cm	↑ cm	€
10791	25 x 19	2,5	7,90



**4 tlg.**  
4 pcs.



11540



11010

**Buche, wasserfest lackiert**  
beech wood lacquered



10791

**Kühlakku halten Ihre Speisen bis zu 6 Stunden kühl**  
cooling system keeps the food cool for up to 6 hours

**Buffetvitrine „TOP FRESH GN 1/1“**

refrigerated buffet display  
expositor buffet frío  
plateau buffet froid



**4-teilig: 1 Box aus Buchenholz mit Kunststoffwanne + 1 Edelstahl-Tablett GN 1/1 + 2 Kühlakkus, ohne Haube**

4 pcs.: 1 beech wood box with plastic insert + 1 stainless steel tray GN 1/1 + 2 coolers, without cover

set de 4: 1 caja de madera de haya con bandeja de plástico + 1 bandeja de acero inoxidable GN 1/1 + 2 acumuladores de frío, sin campana

set de 4: 1 boîte en bois de hêtre avec bac en plastique + 1 plateau en acier inox GN 1/1 + 2 accumulateurs de froid, sans cloche

	cm	↑ cm	€
11540	60 x 41	5	189,00

**GN Rolltophaube mit Goldgriff / GN rolltop cover with gold handle / GN campana rolltop con asa dorada / GN cloche rolltop avec poignée en or**

	cm	↑ cm	GN	€
11008	53 x 32,5	19	1/1	62,00

**GN Rolltophaube mit Chromgriff / GN rolltop cover with chrome handle / GN campana rolltop con asa cromada / GN cloche rolltop avec poignée chromée**

	cm	↑ cm	GN	€
11010	53 x 32,5	19	1/1	62,00

**Kühlakku / cooler / acumulador de frío / accumulateur de froid**

	cm	↑ cm	€
10791	25 x 19	2,5	7,90

**12 tlg.**  
12 pcs.



11541

**Buche, wasserfest lackiert**  
beech wood lacquered



10791

**Kühlakku halten Ihre Speisen bis zu 6 Stunden kühl**  
cooling system keeps the food cool for up to 6 hours

**Buffetvitrine „DOPPELDECKER GN 1/1“**

cooling buffet display  
expositor buffet frío  
vitrine buffet



**12-teilig: 2 Boxen aus Buchenholz mit Kunststoffwanne + 2 Edelstahl-Tabletts GN 1/1 + 4 Kühlakkus + 4 verchromte Stangen, ohne Hauben**

12 pcs.: 2 beech wood boxes with plastic insert + 2 stainless steel trays GN 1/1 + 4 coolers + 4 chrome-plated bars, without covers

set de 12: 2 cajas de madera de haya con bandeja de plástico + 2 bandejas de acero inoxidable GN 1/1 + 4 acumuladores de frío + 4 barras cromadas, sin campanas

set de 12: 2 boîtes en bois de hêtre avec bac en plastique + 2 plateaux en acier inox GN 1/1 + 4 accumulateurs de froid + 4 barres chromées, sans cloches

	cm	↑ cm	€
11541	60 x 41	36	348,00

**GN Rolltophaube mit Goldgriff / GN rolltop cover with gold handle / GN campana rolltop con asa dorada / GN cloche rolltop avec poignée en or**

	cm	↑ cm	GN	€
11008	53 x 32,5	19	1/1 Gold-Griff	62,00

**GN Rolltophaube mit Chromgriff / GN rolltop cover with chrome handle / GN campana rolltop con asa cromada / GN cloche rolltop avec poignée chromée**

	cm	↑ cm	GN	€
11010	53 x 32,5	19	1/1 Chrom-Griff	62,00

**Kühlakku / cooler / acumulador de frío / accumulateur de froid**

	cm	↑ cm	€
10791	25 x 19	2,5	7,90

## COOLING DISPLAYS



09100



90902

11101

**Kühlakkus halten Ihre Speisen bis zu 6 Stunden kühl**  
cooling system keeps the food cool for up to 6 hours

### Buffetvitrine showcase vitrina de buffet vitrine de buffet



5-teilig: 1 transparente Rolltophaube beidseitig aufklappbar + 1 Schale (ABS)  
+ 1 Edelstahl-Tablett 39 x 28 cm + 2 Kühlakkus

5 pcs.: 1 transparent rolltop cover + 1 tray (ABS) + 1 stainless tray 39 x 28 cm + 2 coolers  
set de 5: 1 tapa abatible, por ambos lados, transparente + 1 bandeja (ABS) + 1 bandeja de  
acero inoxidable 39 x 28 cm + 2 acumuladores de frío

set de 5: 1 cloche transparente ouverture 2 côtés + 1 caisson (ABS) + 1 plateau en acier inox  
39 x 28 cm + 2 accumulateurs de froid

	cm	↑ cm	Farbe / Colour	€
09100	44 x 32	20,5	White	50,00
09104	44 x 32	20,5	Black	50,00

#### Kühlakku / cooler / acumulador de frío / accumulateur de froid

	cm	↑ cm	pcs.	€ / set
11101	16 x 7,5	2	4	6,60

#### Edelstahl-Tablett / stainless steel tray / bandeja de acero inoxidable / plateau inox

	cm	↑ cm	€
90902	39,5 x 28,5	1	9,60



Servierbeispiel  
presentation example



09200



09204

### Buffetvitrine „DOPPELDECKER“ showcase vitrina de buffet, 2 alturas vitrine de buffet double



2 transparente Rolltophauben beidseitig aufklappbar + 2 Schalen (ABS) + 2 Edelstahl-Tabletts  
39 x 28 cm + 4 Kühlakkus, platzsparend lagerbar

2 transparent rolltop cover + 2 trays (ABS) + 2 tray 39 x 28 cm + 4 coolers, space saving  
2 campanas abatibles por ambos lados transparentes + 2 bandejas (ABS) + 2 bandejas de acero  
inoxidables 39 x 28 cm + 4 acumuladores de frío, almacenamiento en poco espacio

2 cloches transparentes abattantes 2 côtés + 2 caissons (ABS) + 2 plateaux en acier inox  
39 x 28 cm + 4 accumulateurs de froid, peut encombrant à stocker

	cm	↑ cm	Farbe / Colour	€
09200	44 x 32	44	White	99,00
09204	44 x 32	44	Black	99,00

#### Kühlakku / cooler / acumulador de frío / accumulateur de froid

	cm	↑ cm	pcs.	€ / set
11101	16 x 7,5	2	4	6,60

#### Edelstahl-Tablett / stainless steel tray / bandeja de acero inoxidable / plateau inox

	cm	↑ cm	€
90902	39,5 x 28,5	1	9,60



6 tlg.  
6 pcs.

**Thermo Tablett-Set, 6-teilig**

thermo tray, 6 pcs.  
bandeja térmica, set de 6  
plateau thermique, set de 6



- 6-teilig:
- 1 Schale
  - 1 Edeltahltablett
  - 2 Kühlakkus
  - 1 transparente Frischhaltehaube
  - 1 Transport- und Tragegurt aus Silikon

- 6 pcs.:
- 1 plastic tray
  - 1 stainless steel tray
  - 2 coolers
  - 1 transparent cover
  - 1 silicone transport and carrying strap

- set de 6:
- 1 bandeja de plástico
  - 1 bandeja de acero inoxidable
  - 2 acumuladores de frío
  - 1 campana transparente
  - 1 correa de silicona para cierre y transporte

- set de 6:
- 1 plateau plastique
  - 1 plateau en acier inox
  - 2 accumulateurs de froid
  - 1 cloche transparente
  - 1 sangle en silicone pour fermeture et transport

inklusive  
Transport- und  
Tragegurt!

	cm	↑ cm	Farbe / Colour	€ / set
09091	43 x 29	14		27,00
09090	43 x 29	14		27,00



inklusive 2 Kühlakkus  
including 2 coolers



6 tlg.  
6 pcs.

**Thermo Tablett-Set, 6-teilig**

thermo tray, 6 pcs.  
bandeja térmica, set de 6  
plateau thermique, set de 6



- 6-teilig:
- 1 Schale
  - 1 Edeltahltablett
  - 2 Kühlakkus
  - 1 transparente Frischhaltehaube
  - 1 Transport- und Tragegurt aus Silikon

- 6 pcs.:
- 1 plastic tray
  - 1 stainless steel tray
  - 2 coolers
  - 1 transparent cover
  - 1 silicone transport and carrying strap

- set de 6:
- 1 bandeja de plástico
  - 1 bandeja de acero inoxidable
  - 2 acumuladores de frío
  - 1 campana transparente
  - 1 correa de silicona para cierre y transporte

- set de 6:
- 1 plateau plastique
  - 1 plateau en acier inox
  - 2 accumulateurs de froid
  - 1 cloche transparente
  - 1 sangle en silicone pour fermeture et transport

inklusive  
Transport- und  
Tragegurt!

	cm	↑ cm	Farbe / Colour	€ / set
09094	35	15		27,00
09093	35	15		27,00



inklusive 2 Kühlakkus  
including 2 coolers

## COOLING DISPLAYS

**3 tlg.**  
3 pcs.



11542

**Buche, wasserfest lackiert**  
beech wood lacquered



18388

11542



10791

**Kühlakkus halten Ihre Speisen bis zu 6 Stunden kühl**  
cooling system keeps the food cool for up to 6 hours

### Kühltablett „TOP FRESH RUND“

refrigerated buffet display  
expositor buffet frío redondo  
présentoir buffet



3-teilig: 1 Box aus Buchenholz mit Kunststoffwanne + 1 Edelstahl-Tablett Ø 38 cm  
+ 1 Kühlakku, ohne Haube

3 pcs.: 1 beech wood box with plastic insert + 1 stainless tray Ø 38 cm + 1 cooler, without cover

set de 3: 1 caja de madera de haya con bandeja de plástico + 1 bandeja de acero inoxidable Ø 38 cm + 1 acumulador de frío, sin campana

set de 3: 1 boîte en bois de hêtre avec bac en plastique + 1 plateau en acier inox Ø 38 cm + 1 accumulateur de froid, sans cloche

	Ø cm	↑ cm	€
11542	48	6	189,00

**Rolltophaube mit verchromtem Kugelgriff** / rolltop cover with chrome-plated ball handle / campana abatible con asa de bola cromada / cloche basculante avec poignée boule chromée

	Ø cm	↑ cm	€
18388	38	20	24,00

**Rolltophaube mit vergoldetem Kugelgriff** / rolltop cover with gold-plated ball handle / campana abatible con asa de bola dorada / cloche basculante avec poignée boule plaquée or

	Ø cm	↑ cm	€
18387	38	20	24,00

**Kühlakku** / cooler / acumulador de frío / accumulateur de froid

	cm	↑ cm	€
10791	25 x 19	2,5	7,90

**11 tlg.**  
11 pcs.



11543

**Buche, wasserfest lackiert**  
beech wood lacquered



10791

**Kühlakkus halten Ihre Speisen bis zu 6 Stunden kühl**  
cooling system keeps the food cool for up to 6 hours

### Buffetvitrine „DOPPELDECKER“

double refrigerated buffet display  
expositor de buffet redondo doble  
présentoir buffet froid, double



11-teilig: 2 Boxen aus Buchenholz mit Kunststoffwanne + 2 Edelstahl-Tablets Ø 38 cm  
+ 2 Kühlakkus + 2 Kunststoffschalen + 3 verchromte Stangen, ohne Hauben

11 pcs.: 2 beech wood boxes with plastic tray + 2 stainless steel trays Ø 38 cm, 2 coolers + 3 chrome-plated bars, without covers

set de 11: 2 cajas de madera de haya con bandeja de plástico + 2 bandejas de acero inoxidable Ø 38 cm + 2 acumuladores de frío + 2 bandejas de plástico + 3 barras cromadas, sin campanas

set de 11: 2 boîtes en bois de hêtre avec bac en plastique + 2 plateaux en inox Ø 38 cm + 2 accumulateurs de froid + 2 plateaux en plastique + 3 barres chromées, sans cloches

	Ø cm	↑ cm	€
11543	48	38	312,00

**Rolltophaube mit verchromtem Kugelgriff** / rolltop cover with chrome-plated ball handle / campana abatible con asa de bola cromada / cloche basculante avec poignée boule chromée

	Ø cm	↑ cm	€
18388	38	20	24,00

**Rolltophaube mit vergoldetem Kugelgriff** / rolltop cover with gold-plated ball handle / campana abatible con asa de bola dorada / cloche basculante avec poignée boule plaquée or

	Ø cm	↑ cm	€
18387	38	20	24,00

**Kühlakku** / cooler / acumulador de frío / accumulateur de froid

	cm	↑ cm	€
10791	25 x 19	2,5	7,90

18388

09082

11101

**Kühlakkus halten Ihre Speisen bis zu 6 Stunden kühl**  
cooling system keeps the food cool for up to 6 hours

**Thermo-Set**  
thermo set  
bandeja isotérmica  
set thermo



**5-teilig: 1 Tablett tief + 1 Tablett flach + 2 Kühlakkus + 1 Rolltophaube**

5 pcs.: 1 deep tray + 1 tray + 2 cooler + 1 rolltop cover

set de 5: 1 bandeja honda + 1 bandeja plana + 2 acumuladores frío + 1 campana rolltop

set de 5: 1 plateau creux + 1 plateau plat + 2 accumulateurs de froid + 1 cloche rolltop

	Ø cm	↑ cm	€
09082	38	24	52,00

**Rolltophaube mit verchromtem Kugelgriff** / rolltop cover with chrome-plated ball handle /  
campana abatible con asa de bola cromada / cloche basculante avec poignée boule chromée

	Ø cm	↑ cm	€
18388	38	20	24,00

**Kühlakku** / cooler / acumulador de frío / accumulateur de froid

	cm	↑ cm	pcs.	€/ set
11101	16 x 7,5	2	4	6,60

4 tlg.  
4 pcs.

09083

11101

**Kühlakkus halten Ihre Speisen bis zu 6 Stunden kühl**  
cooling system keeps the food cool for up to 6 hours

**Thermo-Set**  
thermo set  
porta tartas refrigerado  
porte-gâteau réfrigéré



**4-teilig: 1 Tablett tief auf Fuß + 1 Tablett flach + 2 Kühlakkus**

4 pcs.: 1 deep tray with feet + 1 tray + 2 coolers

set de 4: 1 bandeja honda con pie + 1 bandeja plana + 2 acumuladores de frío

set de 4: 1 plateau creux avec pied + 1 plateau plat + 2 accumulateurs de froid

	Ø cm	↑ cm	€
09083	38	14,5	52,00

**Rolltophaube mit verchromtem Kugelgriff** / rolltop cover with chrome-plated ball handle /  
campana abatible con asa de bola cromada / cloche basculante avec poignée boule chromée

	Ø cm	↑ cm	€
18388	38	20	24,00

**Kühlakku** / cooler / acumulador de frío / accumulateur de froid

	cm	↑ cm	pcs.	€/ set
11101	16 x 7,5	2	4	6,60

## COOLING DISPLAYS

**4 tlg.**  
**4 pcs.**

9 cm

11812 **0,6 ltr.**

11,5 cm

11813 **1 ltr.**

10661

**Kühlakku halten Ihre Speisen bis zu 6 Stunden kühl**  
cooling system keeps the food cool for up to 6 hours

### Kühlschale Mini Holz „TOP FRESH“

cool bowl mini holz  
bol refrigerado mini madera  
bol réfrigéré mini bois



**4-teilig: 1 Fuß Buchenholz versiegelt + 1 Schale + 1 Kühlakku + 1 klappbarer Deckel mit Beschriftungsschild**

4 pcs.: 1 foot beech wood + 1 bowl + 1 cooler + 1 hinged cover with label  
set de 4: 1 base de madera de haya + 1 cuenco + 1 acumulador de frío + 1 tapa abatible con etiqueta  
set de 4: 1 pied en hêtre + 1 bac + 1 accumulateur de froid + 1 couvercle à charnière avec étiquette

	Ø cm	↑ cm	ltr.	€
11812	14	9,0	0,6	44,00
11813	14	11,5	1,0	48,00

**Ersatzschale / spare bowl / cuenco de recambio / bol de rechange**

	Ø cm	↑ cm	€
11811	14	6,5	18,20
11816	14	9,0	25,40

**Schutzdeckel mit Löffelaussparung / cover / tapa / couvercle**

	Ø cm	€
11868	14,5	12,00

**Kühlakku / cooler / acumulador de frío / accumulateur de froid**

	Ø cm	↑ cm	€
10661	10,5	2	3,40

**4 tlg.**  
**4 pcs.**

14 cm

11817  
**2,5 ltr.**

18 cm

11818  
**4 ltr.**

### Kühlschale Maxi Holz „TOP FRESH“

cool bowl maxi holz  
bol refrigerado maxi madera  
bol réfrigéré maxi bois



**4-teilig: 1 Fuß Buchenholz versiegelt + 1 Schale + 1 Kühlakku + 1 klappbarer Deckel mit Beschriftungsschild**

4 pcs.: 1 foot beech wood + 1 bowl + 1 cooler + 1 hinged cover with label  
set de 4: 1 base de madera de haya + 1 cuenco + 1 acumulador de frío + 1 tapa abatible con etiqueta  
set de 4: 1 pied en hêtre + 1 bac + 1 accumulateur de froid + 1 couvercle à charnière avec étiquette

	Ø cm	↑ cm	ltr.	€
11817	22	14	2,5	104,00
11818	22	18	4,0	112,00

**Ersatzschale / spare bowl / cuenco de recambio / bol de rechange**

	Ø cm	↑ cm	€
11846	22	8	41,00
11848	22	12	54,00

**Schutzdeckel mit Löffelaussparung / cover / tapa / couvercle**

	Ø cm	€
11878	23,5	12,60

**Kühlakku / cooler / acumulador de frío / accumulateur de froid**

	Ø cm	↑ cm	€
10777	15	2,5	5,40

**4 tlg.**  
4 pcs.



9 cm

11812 0,6 ltr.



11,5 cm

11815 1 ltr.



10661

**Kühlakku halten Ihre Speisen bis zu 6 Stunden kühl**  
cooling system keeps the food cool for up to 6 hours

**Kühlschale Mini „TOP FRESH“**

cool bowl mini  
bol refrigerado mini  
bol réfrigéré mini



**4-teilig: 1 Edelstahlgefäß matt + 1 Kühlakku + 1 Schale + 1 klappbarer Deckel mit Beschriftungsschild**

4 pcs.: 1 stainless steel bowl matt + 1 bowl + 1 cooler + 1 hinged cover with label  
set de 4: 1 recipiente de acero inoxidable mate + 1 cuenco + 1 acumulador de frío + 1 tapa abatible con etiqueta

set de 4: 1 récipient en acier inox mat + 1 bac + 1 accumulateur de froid + 1 couvercle à charnière avec étiquette

	Ø cm	↑ cm	ltr.	€
11810	14	9,0	0,6	48,00
11815	14	11,5	1,0	50,00

**Ersatzschale / spare bowl / cuenco de recambio / bol de rechange**

	Ø cm	↑ cm	€
11811	14	6,5	18,20
11816	14	9,0	25,40

**Schutzdeckel mit Löffelaussparung / cover / tapa / couvercle**

	Ø cm	€
11868	14,5	12,00

**Kühlakku / cooler / acumulador de frío / accumulateur de froid**

	Ø cm	↑ cm	€
10661	10,5	2	3,40

**4 tlg.**  
4 pcs.



14 cm

11847 2,5 ltr.



18 cm

11849 4 ltr.

**Kühlschale Maxi „TOP FRESH“**

cool bowl maxi  
bol refrigerado maxi  
bol réfrigéré maxi



**4-teilig: 1 Edelstahlgefäß hochglanzpoliert + 1 Kühlakku + 1 Schale + 1 klappbarer Deckel mit Beschriftungsschild**

4 pcs.: 1 stainless steel bowl matt + 1 bowl + 1 cooler + 1 hinged cover with label  
set de 4: 1 recipiente de acero inoxidable mate + 1 cuenco + 1 acumulador de frío + 1 tapa abatible con etiqueta

set de 4: 1 récipient en acier inox mat + 1 bac + 1 accumulateur de froid + 1 couvercle à charnière avec étiquette

	Ø cm	↑ cm	ltr.	€
11847	22	14	2,5	108,00
11849	22	18	4,0	112,00

**Ersatzschale / spare bowl / cuenco de recambio / bol de rechange**

	Ø cm	↑ cm	€
11846	22	8	41,00
11848	22	12	54,00

**Schutzdeckel mit Löffelaussparung / cover / tapa / couvercle**

	Ø cm	€
11878	23,5	12,60

**Kühlakku / cooler / acumulador de frío / accumulateur de froid**

	Ø cm	↑ cm	€
10777	15	2,5	5,40

## COOLING DISPLAYS



### Kühlschale Maxi „TOP FRESH“

cool bowl maxi  
cuenco refrigerado maxi  
bol réfrigéré maxi



4-teilig: 1 Gefäß hochglanzpoliert + 1 Kühlakku + 1 Glasschale + 1 klappbarer Deckel mit Beschriftungsschild

4 pcs.: 1 stainless steel bowl mirror polished + 1 cooler + 1 glass bowl + 1 hinged cover with label

set de 4: 1 recipiente de acero inoxidable pulido brillante + 1 acumulador de frío + 1 cuenco de vidrio + 1 tapa abatible con etiqueta

set de 4: 1 récipient en acier inox poli mat + 1 accumulateur de froid + 1 bol en verre + 1 couvercle à charnière avec étiquette

	Ø cm	↑ cm	ltr.	€
11845	23	14	2,5	84,00

#### Ersatzschale / spare bowl / cuenco de recambio / bol de rechange

	Ø cm	↑ cm	ltr.	€
11875	23	10,5	2,5	7,00

#### Schutzdeckel mit Löffelaussparung / cover / tapa / couvercle

	Ø cm	€
11878	23,5	12,60

#### Kühlakku / cooler / acumulador de frío / accumulateur de froid

	Ø cm	↑ cm	€
10777	15	2,5	5,40



### Schale „CASUAL MAXI“

bowl  
cuenco  
bol



	Ø cm	↑ cm	ltr.	Farbe / Colour	€
83696	10	4,5	0,15	White	3,50
83698	12	5,5	0,25	White	4,20
83700	14	6,5	0,50	White	4,90
83704	20	9,2	1,80	White	10,40
83702	23	10,5	2,50	White	11,80

	Ø cm	↑ cm	ltr.	Farbe / Colour	€
83697	10	4,5	0,15	Black	3,50
83699	12	5,5	0,25	Black	4,20
83701	14	6,5	0,50	Black	4,90
83705	20	9,2	1,80	Black	10,40
83703	23	10,5	2,50	Black	11,80



# SNACKPRESENTER

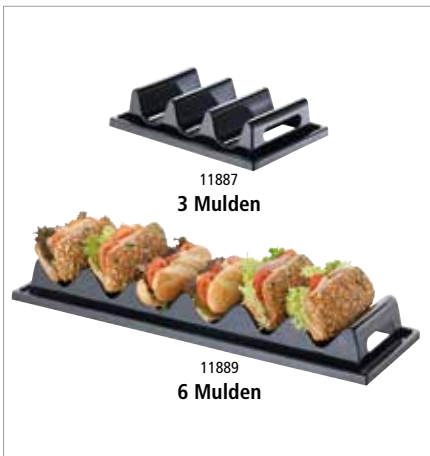

## Snackpresenter

snackpresenter  
dispensador de bocadillos  
présentoir à sandwiches  
mit Safrille und Griffmulde, passend für Vitrine 11888



with recessed grip, suitable for showcase 11888  
asa moldeada, apto para la vitrina 11888  
anse moulée, apte pour vitrine 11888

	cm	↑ cm		€
11887	29 x 19	6,5	3 Mulden / 3 compartments 3 compartimentos / 3 compartments	22,00
11889	60 x 19	7,5	6 Mulden / 6 compartments 6 compartimentos / 6 compartments	25,00



## Snackpresenter

snackpresenter  
dispensador de bocadillos  
présentoir à sandwiches  
hochglanzpoliert, mit Griffmulde, für 7 Baguettes



mirror polished, with recessed grip, for 7 baguettes  
pulido brillante, con asa empotrada, ideal para 7 bocadillos  
poli brillant, avec poignée encastrée, parfait pour 7 sandwiches

	cm	↑ cm		€
11891	47,5 x 10,5	6		32,00



## Snackpresenter

snackpresenter  
dispensador de bocadillos  
présentoir à sandwiches



	cm	↑ cm		€
11969	56 x 8	5,5		14,00



## Vitrine / Thekenaufsatz

showcase  
vitrina de mostrador  
vitrine de comptoir  
rutschfest, aus einem Teil gefertigt



non-slip, monoblock produced  
antideslizante, fabricado en 1 pieza  
antidérapante, fabriquée en une seule pièce

	cm	↑ cm		€
11888	63,5 x 25	25		89,00

# BUFFET GUARD

3 Höhen einstellbar  
3 heights adjustable

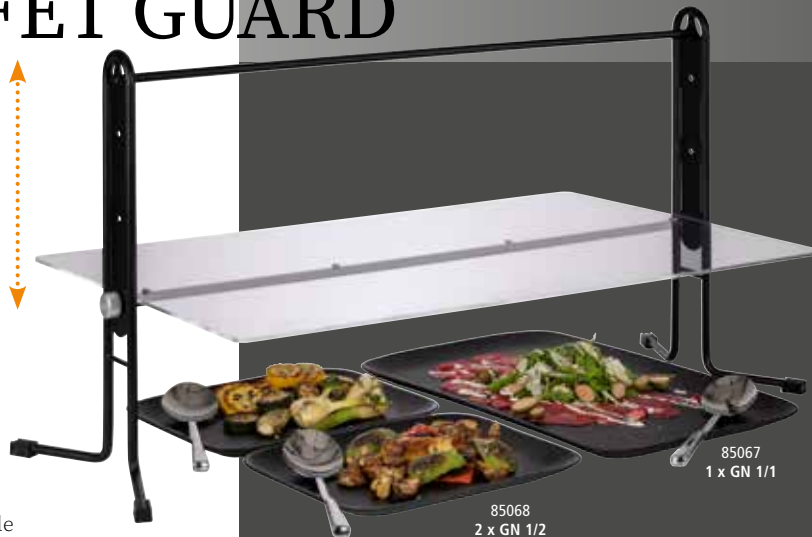

schwenkbar  
swivelling

Servierbeispiel  
presentation example



## Hygieneschutz „BUFFET GUARD“

sneeze guard  
protector anti aliento  
pare-haleine



- transparente, höhenverstellbare Acrylplatte 80 x 53 cm
- Neigungswinkel stufenlos einstellbar
- transparent, height-adjustable acrylic plate 80 x 53 cm
- tilt angle continuously adjustable
- placa acrílica transparente y de altura ajustable 80 x 53 cm
- el ángulo de inclinación es infinitamente variable
- plaque en acrylique transparente 80 x 53 cm et réglable en hauteur
- angle d'inclinaison variable à l'infini

	cm	↑ cm	✂ mm	Fuß / base	€
98120	93 x 53	50,5	5	Metall schwarz / metal black	159,00



Antirutschfüßchen  
non-slip feet



Der Neigungswinkel der Acrylplatte ist flexibel einstellbar  
the angle of inclination of the acrylic plate is flexibly adjustable



Höheneinstellung der Acrylplatte in  
3 Höhen (20 cm - 30 cm - 40 cm)  
height adjustment of the acrylic plate in 3  
steps. (20 cm - 30 cm - 40 cm)



Anwendungsbeispiel  
application example



Lieferung erfolgt demontiert  
delivery takes place disassembled



**Hygieneschutz**  
hygienic cover  
campana higiénica antialiento  
pare-haleine



	cm	↑ cm	€
11556	82 x 42	45	214,00



**Brötchenspender**  
roll dispenser  
dispensador de panecillos  
distributeur de petits pains



hygienisch und einfach zu reinigen, mit Krümelschale  
hygienic and easy to clean, with crumb tray  
higiénico y fácil de limpiar, con bandeja para migas  
hygiénique et facile à laver, avec plat ramasse-miettes

	cm	↑ cm		€
11572	32,5 x 27,5	42	für ca. 45-50 Brötchen / for approx. 45-50 rolls para 45-50 panecillos / pour 45-50 petits pains	199,00
11573	32,5 x 27,5	56	für ca. 65-70 Brötchen / for approx. 65-70 rolls para 65-70 panecillos / pour 65-70 petits pains	229,00



**Buffetgestell**  
buffet stand  
soporte para buffet  
présentoir buffet



3-stufig, Rubberwood, geeignet für Körbe, platzsparend zusammenklappbar  
3-tier, rubberwood, usable for baskets, can be bushed together for place saving  
3 alturas, madera de caucho, apto para cestas, se puede plegar para ahorrar espacio  
3 hauteurs, bois d'hévéa, pour corbeilles, la structure s'ouvre ou se ferme pour réduire l'encombrement

	cm	↑ cm	€
33232	59 x 30,5	59	22,00

**Tisch- und Buffetkorb, rund „ECONOMIC“** / buffet basket, round / cesta de buffet redonda / corbeille de buffet ronde

	Ø cm	↑ cm	Farbe / Colour	€
40144	39,0	10,0		19,00

Lieferung ohne Körbe  
delivery without baskets

# DRAWER SET



50807  
2 x Korb, schwarz

00910  
3-teiliges Set  
3 pcs. set



3 tlg.  
3 pcs.



00910



00911  
mit Antirutsch Füßchen  
with non-slip feet



00912

## Schubladen Set, 3-teilig

drawer set, 3 pcs.  
cajonera, set de 3  
set tiroir, set de 3

3-teiliges Set:

- 1 Ständer aus Metall schwarz
- 1 Schublade mit Griff schwarz
- 1 Schneidebrett aus geöltem Walnussholz

3 pcs. set:

- 1 stand made of metal black
- 1 drawer with handle black
- 1 oiled walnut wood cutting board

set de 3:

- 1 soporte de metal negro
- 1 cajón con asa negra
- 1 tabla de cortar de madera de nogal engrasada

set de 3:

- 1 support métallique noir
- 1 tiroir avec poignée noire
- 1 planche à découper en bois de noyer huilé

HOLZ WOOD ACRYL ACRYLIC METALL

	cm	↑ cm	€ / set
00910	35,4 x 32,5	20	174,00



15506

00912



00911

Anwendungsbeispiele  
application examples

Einzelteile / parts / piezas / pièces

	cm	↑ cm	€
00911	35,4 x 32,5	3,5	Schneidebrett / cutting board 77,00
00912	34,0 x 32,0	17,5	Schublade, Griff schwarz / drawer, handle black 82,00
00914	34,0 x 32,0	17,5	Schublade, Griff chrom / drawer, handle chrome 82,00
15506	35,4 x 32,5	17,6	GN Buffetständer schwarz/ GN buffet stand black 22,80



Neigungswinkel stufenlos einstellbar  
inclination angle continuously adjustable

### Haubenthalterung „FLEXIBLE“

cover holder  
soporte de la campana  
support de la cloche



Bei dieser Haubenthalterung wird die Haube am Griff in die Vorrichtung gesteckt.

Für APS-Hauben geeignet!

With this cover holder, the cover is inserted into the device by the handle.  
Suitable for APS covers!

Con este soporte de campana, la campana se cuelga simplemente por el asa.

¡Para campanas de APS!

Avec ce support, la cloche s'accroche simplement par la poignée.

Pour cloches APS!

	cm	↑ cm	€
33288	35,5 x 30	39	124,00



Anwendungsbeispiele  
application examples



### Tablett mit Haube

tray with cover  
bandeja con campana  
plateau avec cloche



2 teiliges Set:

- 1 Tablett aus geöltem Buchenholz (Ø 18,5 cm, H: 2,5 cm)
- 1 Glas-Haube (Ø 16 cm, H: 22,5 cm)

2 pcs.:

- 1 tray of oiled beech wood (Ø 18,5 cm, H: 2,5 cm)
- 1 glass cover (Ø 16 cm, H: 22,5 cm)

set de 2:

- 1 bandeja de madera de haya (Ø 18,5 cm, H: 2,5 cm)
- 1 campana de cristal (Ø 16 cm, H: 22,5 cm)

set de 2:

- 1 plateau de bois de hêtre (Ø 18,5 cm, H : 2,5 cm)
- 1 couvercle en verre (Ø 16 cm, H : 22,5 cm)

	Ø cm	↑ cm	€/ set
00830	18,5	24	36,00



Präsentationsmöglichkeit  
presentation example

# FRIENDLY



- hergestellt aus gebrauchtem Kunststoff – aus recyceltem Post-Consumer PET
- recycelbar und umweltschonend
- made from used plastic – made of recycled post-consumer PET
- recyclable and environmentally friendly
- fabricado de plástico usada: de PET reciclado postconsumo
- reciclable y ecológico
- fabriqué de plastique usagée – composé à de PET recyclé post-consummation
- recyclable et écologique



79022 0,05 ltr.



79001 0,14 ltr.



79002 0,4 ltr.



79005 1,5 ltr.



79008 3,8 ltr.

## Schale „FRIENDLY“ bowl cuenco bol



friendly

	cm	↑ cm	ltr.	Farbe / Colour	VE / unit	€/ pc.
79022	6,5 x 6,5	3,0	0,05		6	2,00
79023	6,5 x 6,5	3,0	0,05		6	2,00
79000	9,0 x 9,0	4,0	0,14		–	4,20
79001	9,0 x 9,0	4,0	0,14		–	4,20
79002	12,5 x 12,5	6,5	0,40		–	6,00
79003	12,5 x 12,5	6,5	0,40		–	6,00
79004	19,0 x 19,0	9,0	1,50		–	15,00
79005	19,0 x 19,0	9,0	1,50		–	15,00
79008	25 x 25	12,0	3,8		–	19,00
79009	25 x 25	12,0	3,8		–	19,00



Präsentationsmöglichkeit  
presentation example



Dipschälchen „FRIENDLY“  
dip bowl  
cuenco para dip  
ramequin



	Ø cm	↑ cm	ltr.	Farbe / Colour	VE / unit	€ / pc.
79014	6	4,0	0,05	White	6	1,00
79015	6	4,0	0,05	Black	6	1,00



Schälchen „FRIENDLY“  
mini bowl  
mini cuenco  
mini bol



	Ø cm	↑ cm	ltr.	Farbe / Colour	VE / unit	€ / pc.
79016	6,0	2,5	0,02	White	12	1,00
79017	6,0	2,5	0,02	Black	12	1,00
79018	7,5	3,5	0,05	White	12	2,00
79019	7,5	3,5	0,05	Black	12	2,00
79020	10,0	4,5	0,15	White	–	3,00
79021	10,0	4,5	0,15	Black	–	3,00



Schale „FRIENDLY“  
bowl  
cuenco  
bol



	Ø cm	↑ cm	ltr.	Farbe / Colour	€ / pc.
79024	14	6,5	0,5	White	4,00
79025	14	6,5	0,5	Black	4,00
79026	20	9	1,8	White	8,40
79027	20	9	1,8	Black	8,40
79028	23	10,5	2,5	White	9,50
79029	23	10,5	2,5	Black	9,50

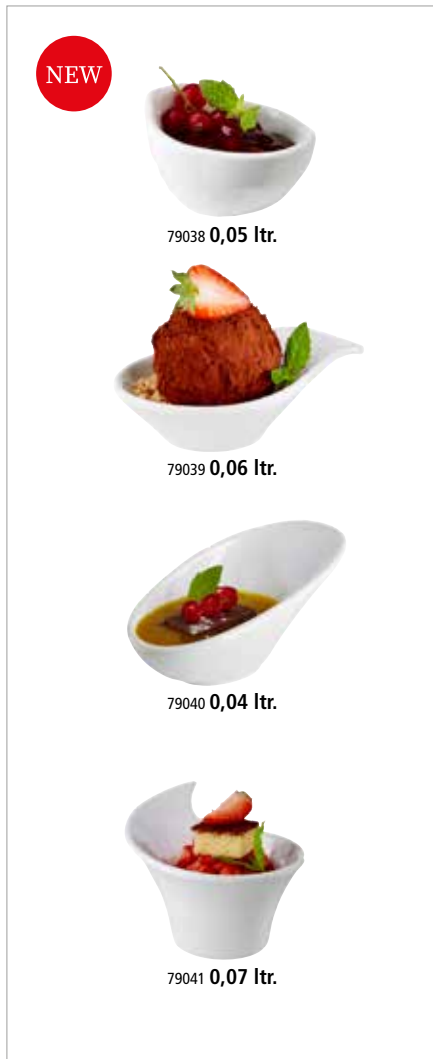

Schale „FRIENDLY“  
bowl  
cuenco  
bol



friendly

	cm	↑ cm	ltr.	Farbe / Colour	VE / unit	€/ pc.
79038	7,5 x 7	4,5	0,05	White	12	1,80
79039	11,5 x 7,5	3,0	0,06	White	12	1,80
79040	11,5 x 6	5,5	0,04	White	12	1,80
79041	8,5 x 7	6,0	0,07	White	12	1,80

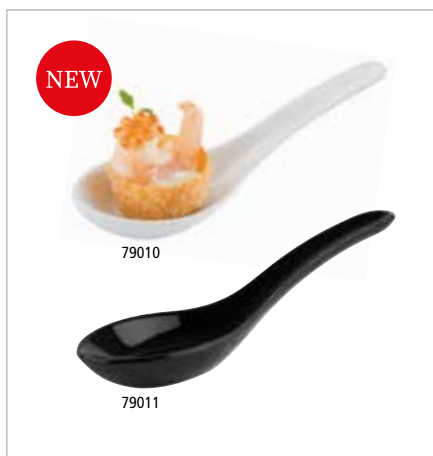

Fingerfoodlöffel „FRIENDLY“  
party spoon  
cuchara party  
cuillère party



friendly

	cm	↑ cm	Farbe / Colour	VE / unit	€/ pc.
79010	13,5 x 4,5	4,5	White	12	1,20
79011	13,5 x 4,5	4,5	Black	12	1,20



Fingerfoodlöffel „FRIENDLY“  
party spoon  
cuchara party  
cuillère party



friendly

	cm	↑ cm	Farbe / Colour	VE / unit	€/ pc.
79012	11 x 4,5	4,0	White	12	1,20
79013	11 x 4,5	4,0	Black	12	1,20





GN Tablett „FRIENDLY“

GN tray  
GN bandeja  
GN plateau



	cm	↑ cm	Farbe / Colour	GN	€
79006	32,5 x 26,5	3,0		1/2	15,80
79007	32,5 x 26,5	3,0		1/2	15,80



GN Behälter „FRIENDLY“

GN pan  
GN cubeta  
GN bac



	cm	↑ cm	ltr.	Farbe / Colour	GN	€
79030	53 x 32,5	6,5	7,1		1/1	24,00
79031	53 x 32,5	6,5	7,1		1/1	24,00
79032	32,5 x 26,5	6,5	3,4		1/2	14,90
79033	32,5 x 26,5	6,5	3,4		1/2	14,90
79034	32,5 x 17,6	6,5	2		1/3	12,80
79035	32,5 x 17,6	6,5	2		1/3	12,80
79036	32,5 x 17,6	10	2,7		1/3	14,90
79037	32,5 x 17,6	10	2,7		1/3	14,90



NEW



30024



30014



30013



30010



30011

Schale „FROSTFIRE“

bowl  
cuenco  
bol



Antihafbeschichtung / non stick coating / antiadherente / revêtement anti-adhésif

	Ø cm	↑ cm	ltr.	Farbe / Colour	€
30024	32,5	8 / 14	3	beige/sand	44,00
30014	32,5	8 / 14	3	red	44,00
30013	32,5	8 / 14	3	green	44,00
30010	32,5	8 / 14	3	black/silver	44,00
30011	32,5	8 / 14	3	black	44,00



Präsentationsmöglichkeit  
presentation example

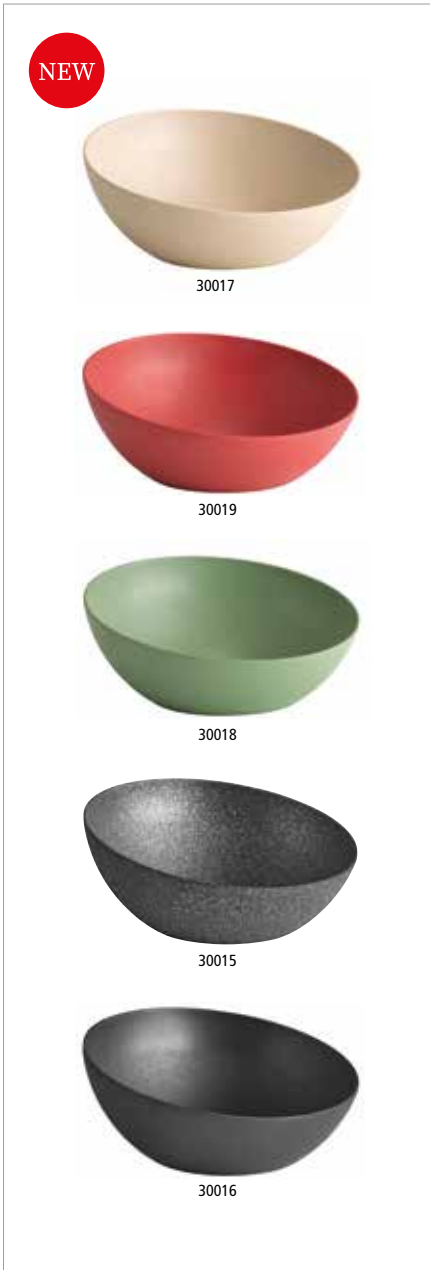

Schale „FROSTFIRE“

bowl  
cuenco  
bol



Antihafbeschichtung / non stick coating / antiadherente / revêtement anti-adhésif

	Ø cm	↑ cm	ltr.	Farbe / Colour	€
30017	26,5	7 / 12	1,9	beige/sand	38,00
30019	26,5	7 / 12	1,9	red	38,00
30018	26,5	7 / 12	1,9	green	38,00
30015	26,5	7 / 12	1,9	black/silver	38,00
30016	26,5	7 / 12	1,9	black	38,00



Wärmelampe mit 2 Infrarotlampen

thermal bridge  
puente térmico  
pont thermique



höhenverstellbar 58 - 77,5 cm, inklusive 2 Lampen, Kabellänge: 1,5 Meter

height ajustable from 58 to 77,5 cm, including 2 infrared lamps, cable length: 1,5 metres  
regulable en altura de 58 a 77,5 cm, con 2 lámparas de infrarrojos, longitud del cable: 1,5 metros  
réglable en hauteur de 58 à 77,5 cm, avec 2 lampes infrarouges, longueur du câble: 1,5 mètre

	cm	↑ cm	V	W	Farbe / Colour	€
12265	50 x 35	58 - 77,5	230	2 x 250		145,00

Ersatzbirne für Wärmelampe

infrared lamp / bulb  
lámpara infrarrojos / bombilla  
lampe infrarouge / ampoule

Fassung E27, Lichtfarbe: warmweiß

socket: E27, light colour: warm white

casquillo: E27, color de la luz: blanco cálido

douille: E27, couleur de lumière: blanc chau

	W	fits to	€
12266	250	12265	10,00



# FROSTFIRE



FROSTFIRE Schalen und Tablett aus gegossenem Aluminium leiten die Wärme und Kälte nicht nur gut, sondern können diese auch lange speichern – ideal für den Einsatz in Kühlvitrinen, -regalen, auf Kühlischen und unter Wärmelampen. FROSTFIRE Schalen und Tablett halten servierbereite Speisen zuverlässig warm oder kalt.

FROSTFIRE bowls and trays made of cast aluminium not only conduct heat and cold well, but can also store it for a long time - ideal for use in refrigerated display cabinets, shelves, on refrigerated tables and under heat lamps. FROSTFIRE bowls and trays reliably keep ready-to-serve food warm or cold.

Los cuencos y las bandejas FROSTFIRE de aluminio fundido no sólo conducen bien el calor y el frío, sino que también pueden conservarlo durante mucho tiempo: ideales para su uso en vitrinas refrigeradas, estanterías, mesas refrigeradas y bajo lámparas de calor. Los cuencos y las bandejas FROSTFIRE mantienen de forma fiable los alimentos listos para servir calientes o fríos.

Les bols et plateaux FROSTFIRE en aluminium moulé conduisent non seulement bien la chaleur et le froid, mais peuvent aussi les conserver longtemps - idéal pour une utilisation dans des vitrines et étagères réfrigérées, sur des tables réfrigérées et sous des lampes chauffantes. Les bols et plateaux FROSTFIRE maintiennent les aliments prêts à être servis au chaud ou au froid de manière fiable.

NEW



## GN Tablett „FROSTFIRE“

GN tray  
GN bandeja  
GN corbeille



Antihftbeschichtung / non stick coating / antiadherente / revêtement anti-adhésif

	cm	↑ cm	GN	Farbe / Colour	€
30500	53 x 32,5	3	1/1	black/silver	49,00
30501	32,5 x 26,5	3	1/2	black/silver	34,00
30502	53 x 16,2	3	2/4	black/silver	36,00





Schale „FROSTFIRE“

bowl  
cuenco  
bol



Antihafbeschichtung / non stick coating / antiadherente / revêtement anti-adhésif

	cm	↑ cm	ltr.	Farbe / Colour	€
30503	19 x 19	9	1,5	black/silver	26,00
30504	25 x 25	12	3,8	black/silver	39,00



Dressingtopf / Flaschenkühler „FROSTFIRE“

dressing pot / bottle cooler  
salsera / enfriador de botella  
pot à sauce / rafraîchisseur



Antihafbeschichtung / non stick coating / antiadherente / revêtement anti-adhésif

	Ø cm	↑ cm	ltr.	Farbe / Colour	€
36140	11,5 / 11	15	1,5	black/silver	16,00



auch als Flaschenkühler verwendbar  
also usable as a bottle cooler



Wärmelampe mit 2 Infrarotlampen

thermal bridge  
puente térmico  
pont thermique



höhenverstellbar 58 - 77,5 cm, inklusive 2 Lampen, Kabellänge: 1,5 Meter

height ajustable from 58 to 77,5 cm, including 2 infrared lamps, cable length: 1,5 metres  
regulable en altura de 58 a 77,5 cm, con 2 lámparas de infrarrojos, longitud del cable: 1,5 metros  
réglable en hauteur de 58 à 77,5 cm, avec 2 lampes infrarouges, longueur du câble: 1,5 mètre

	cm	↑ cm	V	W	Farbe / Colour	€
12265	50 x 35	58 - 77,5	230	2 x 250	black	145,00

Ersatzbirne für Wärmelampe

infrared lamp / bulb  
lámpara infrarrojos / bombilla  
lampe infrarouge / ampoule

Fassung E27, Lichtfarbe: warmweiß

socket: E27, light colour: warm white

casquillo: E27, color de la luz: blanco cálido

douille: E27, couleur de lumière: blanc chaud

	W	fits to	€
12266	250	12265	10,00

# PERFECTO



## 2-stufige Etagère „PERFECTO SMALL“

2-tier tray  
bandeja dos alturas  
étagère carré 2 hauteurs



### 3-teiliges Set, bestehend aus:

- 1 Buffetständer, Metall, PVC, schwarz, 23 x 19 cm, H: 40,5 cm
- 2 Bretter aus Eichenholz, geölt, 20 x 20 cm, H: 2 cm

3 pcs., consisting of:

- 1 buffet stand, metal, PVC, black, 23 x 19 cm, h: 40,5 cm
- 2 boards, oiled oak, 20 x 20 cm, h: 2 cm

set de 3, compuesto por:

- 1 soporte buffet, metal, PVC, negro, 23 x 19 cm, a: 40,5 cm
- 2 tablas de roble, aceitadas, 20 x 20 cm, a: 2 cm

set de 3, composé de :

- 1 support de buffet, métal, PVC, noir, 23 x 19 cm, h: 40,5 cm
- 2 planches en bois de chêne, huilées, 20 x 20 cm, h: 2 cm

	cm	↑ cm	€ / set
33300	20 x 23	40,5	48,00

### Brett aus Eichenholz / oak board / tabla de roble / planche en chêne

	cm	↑ cm	€
33302	20 x 20	2	13,60

### Buffetständer / buffet stand / soporte de buffet / support de buffet

	cm	↑ cm	€
33304	19 x 23	40,5	23,60



Präsentationsmöglichkeit  
presentation example



4 tlg.  
4 pcs.

33301  
4-teiliges Set | 4 pcs.

33303

33304

2-stufige Etagère „PERFECTO LARGE“

2-tier tray  
bandeja dos alturas  
étagère carré 2 hauteurs



4-teiliges Set, bestehend aus:  
• 2 Buffetständer, Metall, PVC, schwarz, 23 x 19 cm, H: 40,5 cm  
• 2 Bretter aus Eichenholz, geölt, 80 x 20 cm, H: 2 cm

4 pcs., consisting of:  
• 2 buffet stands, metal, PVC, black, 23 x 19 cm, h: 40,5 cm  
• 2 boards, oiled oak, 80 x 20 cm, h: 2 cm

set de 4, compuesto por:  
• 2 soportes buffet, metal, PVC, negro, 23 x 19 cm, a: 40,5 cm  
• 2 tablas de roble, aceitadas, 80 x 20 cm, a: 2 cm

set de 4, composé de :  
• 2 supports de buffet, métal, PVC, noir, 23 x 19 cm, h: 40,5 cm  
• 2 planches en bois de chêne, huilées, 80 x 20 cm, h: 2 cm

	cm	↑ cm	€ / set
33301	80 x 23	40,5	150,00

Brett aus Eichenholz / oak board / tabla de roble / planche en chêne

	Ø cm	↑ cm	€
33303	80 x 20	2	53,00

Buffetständer / buffet stand / soporte de buffet / support de buffet

	cm	↑ cm	€
33304	19 x 23	40,5	23,60



Präsentationsmöglichkeit  
presentation example



Präsentationsmöglichkeit 3 Buffetständer + 4 Bretter  
presentation example 3 buffet stands / 4 boards



platzsparend  
space saving

# BUFFET STAND



Eichenholz geölt  
oak wood oiled



83481  
GN 1/3



83491  
GN 1/3

## Buffetständer „WINDOW“

buffet stand  
soporte para buffet  
présentoir buffet

Eichenholz geölt  
oak wood oiled  
madera de roble aceitada  
bois de chêne huilé



	cm	↑ cm		€
11740	35,5 x 19	37	inkl. 20 Haltestiften für Einlegeböden / incl. 20 fixing pins for shelves	84,00



inklusive 20 Haltestifte  
including 20 fixing pins



Präsentationsmöglichkeiten  
presentation examples

geeignet für GN 1/3 Tablett / for GN 1/3 trays / para bandejas GN 1/3 / pour plateaux GN 1/3

	cm	↑ cm	Farbe / Colour	€
84187	32,5 x 17,6	1,5		15,60
83481	32,5 x 17,6	3,0		17,00
83491	32,5 x 17,6	3,0		17,00



NEW



**Buffet Box**

buffet box  
caja buffet  
boîte à buffet



**Eichenholz, geölt, Innenmaße: 15,5 x 10 cm**

oak wood oiled, interior dimensions: 15,5 x 10 cm  
madera de roble aceitada, medidas int.: 15,5 x 10 cm  
bois de chêne huilé, dimensions int.: 15,5 x 10 cm

	cm	↑ cm	€
11728	17,5 x 15,5	12,5	22,00

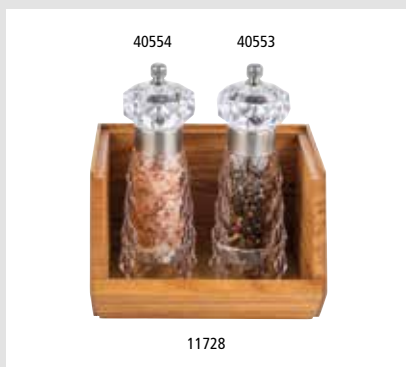

Präsentationsmöglichkeit  
presentation example



stapelbar  
stackable

NEW



**Buffet Box**

buffet box  
caja buffet  
boîte à buffet



**aus geöltem Eichenholz, 2 Fächer je: 25 x 16 cm, mit 2 Griffmulden**

made of oiled oak wood, 2 compartments: each 25 x 16 cm, with 2 recessed grips  
de madera de roble aceitada, 2 compartimentos de 25 x 16 cm, con 2 asas empotradas  
en bois de chêne huilé, 2 compartiments: chacun 25 x 16cm, avec 2 poignées encastées

	cm	↑ cm	€
11729	35 x 31	12,5	52,00



Präsentationsmöglichkeit  
presentation example

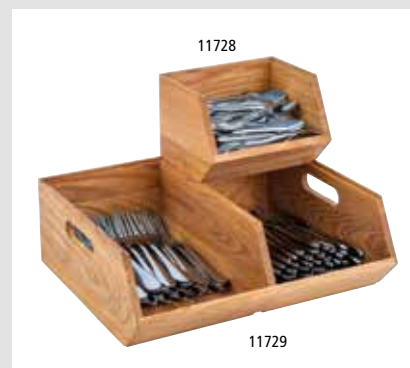

stapelbar  
stackable

## BUFFET BOX



### Buffet Box „TOAST BOX“

buffet box  
caja de buffet  
boîte de buffet



aus geöltem Eichenholz, Deckel aus Kunstleder, 2 Fächer: 28 x 16,5 cm, H: 16 cm, mit herausnehmbarem Sichtfenster aus Acryl

made of oiled oak wood, lid made of imitation leather, 2 compartments: 28 x 16.5 cm, H: 16 cm, with removable viewing window made from acrylic

de madera de roble aceitada, tapa de polipiel, 2 compartimentos: 28 x 16,5 cm, H: 16 cm, con ventanilla acrílica extraíble

en bois de chêne huilé, couvercle en simili-cuir, 2 compartiments : 28 x 16,5 cm, H : 16 cm, avec fenêtre amovible en acrylique

	cm	↑ cm	Farbe / Colour	€
11713	36 x 33,5	16	natural oak	99,00
11714	36 x 33,5	16	dark oak	99,00



Präsentationsmöglichkeit  
presentation example



### Buffet Box „SEWING BASKET“

buffet box  
caja de buffet  
boîte de buffet



aus geöltem Eichenholz, 3 Fächer: 33 x 27 cm, H: 7 cm, passend für GN 1/2

made of oiled oak wood, 3 compartments: 33 x 27 cm, H: 7 cm, suitable for GN 1/2

de madera de roble aceitada, 3 compartimentos: 33 x 27 cm, H: 7 cm, para GN 1/2

en bois de chêne huilé, 3 compartiments: 33 x 27 cm, H: 7 cm, pour GN 1/2

	cm	↑ cm	Farbe / Colour	€
11711	36 x 29	28	natural oak	298,00
11712	36 x 29	28	dark oak	298,00

geschlossen | closed  
37 x 29 cm, H: 28 cm

geöffnet | open  
70,5 x 37 cm, H: 53,5 cm

passend für GN 1/2  
suitable for GN 1/2



Präsentationsmöglichkeit  
presentation example



**Buffetgestell „TRIANGLE“**

buffet stand  
expositor de buffet  
présentoir buffet



**Buche massiv, 3 Ebenen: 1.: 53 x 19 cm, 2.: 40 x 17,5 cm, 3.: 30 x 15 cm**

beech maple, 3 levels: 1.: 53 x 19 cm, 2.: 40 x 17,5 cm, 3.: 30 x 15 cm

haya sólido, 3 niveles: 1.: 53 x 19 cm, 2.: 40 x 17,5 cm, 3.: 30 x 15 cm

hêtre massif, 3 niveaux: 1.: 53 x 19 cm, 2.: 40 x 17,5 cm, 3.: 30 x 15 cm

	cm	↑ cm	Farbe / Colour		€
13966	53 x 21	50		Wenge / wenge	145,00

**Buche massiv, 3 Ebenen: 1.: 53 x 19 cm, 2.: 40 x 17,5 cm, 3.: 30 x 15 cm**

beech maple, 3 levels: 1.: 53 x 19 cm, 2.: 40 x 17,5 cm, 3.: 30 x 15 cm

haya sólido, 3 niveles: 1.: 53 x 19 cm, 2.: 40 x 17,5 cm, 3.: 30 x 15 cm

hêtre massif, 3 niveaux: 1.: 53 x 19 cm, 2.: 40 x 17,5 cm, 3.: 30 x 15 cm

	cm	↑ cm	Farbe / Colour		€
14966	53 x 21	50		Wenge / wenge	145,00



**Buffetgestell „BIRDCAGE“**

buffet stand  
soporte para buffet  
présentoir buffet



**Gestell aus schwarzem Metall, inklusive 2 Akazienholzplatten**

black metal frame, incl. 2 acacia wood panels

soporte metálico negro, con 2 tablas de madera de acacia

support métallique noir, avec 2 panneaux en bois d'acacia

	Ø cm	↑ cm		€
33206	26	54		55,00

**Ersatz-Holzplatte**

spare wooden panel

tabla de madera de recambio

panneau en bois de rechange

	Ø cm	↑ cm		€
33207	25	1		15,40



passende Akazienholzplatte  
fitting acacia wood panels



Gestell mit abgerundeten Füßen  
frame with rounded feet

# SERVING STANDS

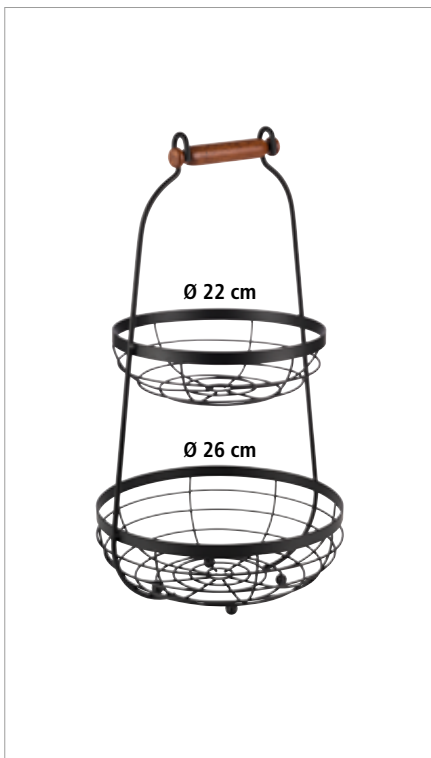

## 2-stufige Etagère

2-tier étagère  
cesta doble 2 alturas  
étagère 2 paniers

Griff aus Holz, Körbe aus Metall schwarz,  
oberer Korb (Ø 22 cm, H: 6 cm), unterer Korb (Ø 26 cm, H: 8 cm)

wooden handle, baskets made of metal black,  
upper basket (Ø 22 cm, H: 6 cm), lower basket (Ø 26 cm, H: 8 cm)

asa de madera, cestas de metal negro,  
cesta superior (Ø 22 cm, H: 6 cm), cesta inferior (Ø 26 cm, H: 8 cm)

manche en bois, corbeilles en métal noir,  
corbeille supérieure (Ø 22 cm, H: 6 cm), corbeille inférieure (Ø 26 cm, H: 8 cm)



	Ø cm	↑ cm	€
30335	26	48	42,00



Präsentationsmöglichkeiten  
presentation examples

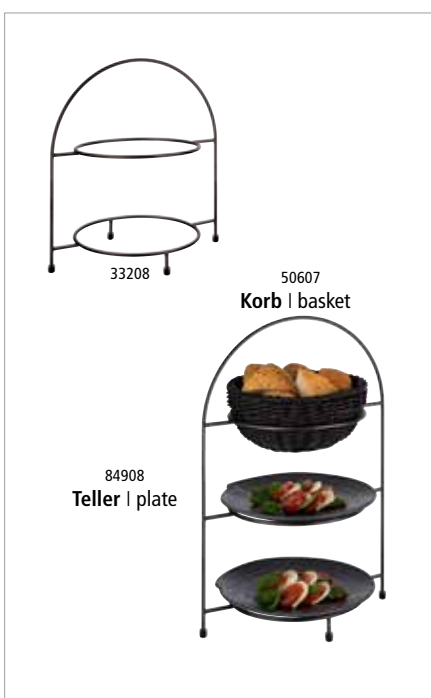

## Serviergestell „INDUSTRIAL“

serving stand  
soporte platos  
présentoir à assiettes

für Teller max. Ø 27 cm, innerer Ring Ø 18 cm, Lieferung ohne Teller

for plates max. Ø 27 cm, circle inside Ø 18 cm, delivery without dishes

para platos máx. Ø 27 cm, aro interior Ø 18 cm, se entrega sin platos

pour assiettes Ø 27 cm maxi., anneau intérieur Ø 18 cm, livré sans assiettes



	cm	↑ cm		passend für Tellerabdeckhauben / suitable for plate covers	€
33208	29 x 19,5	30	2 Teller Ø 27 cm innerer Ring Ø 18 cm	11051, 11052	33,00
33209	29 x 19,5	43	3 Teller Ø 27 cm innerer Ring Ø 18 cm	11051, 11052	42,00

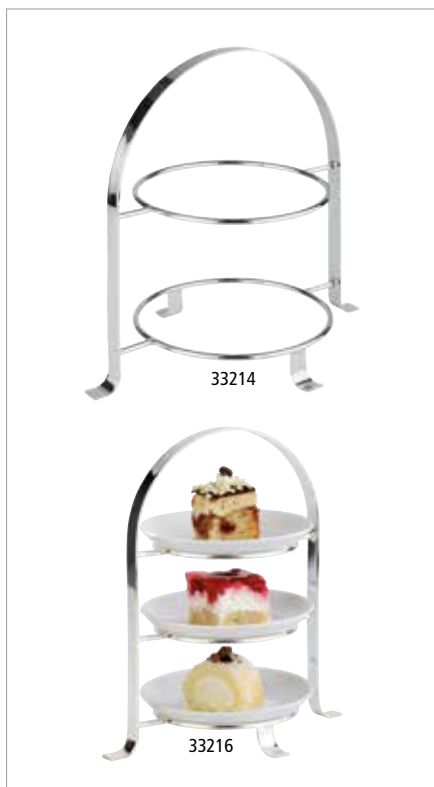

**Serviergestell**

servicing stand  
soporte platos  
présentoir à assiettes



**für 3 Teller max. Ø 27 cm, innerer Ring Ø 18 cm**  
for 3 plates max. Ø 27 cm, circle inside Ø 18 cm  
para 3 platos Ø 27 cm, aro interior Ø 18 cm  
pour 3 assiettes maxi Ø 27 cm, anneau intérieur Ø 18 cm

	cm	↑ cm	€
33217	33 x 24	43	52,00

**für 2 Teller max. Ø 27 cm, innerer Ring Ø 18 cm, Lieferung ohne Teller**  
for 2 plates max. Ø 27 cm, circle inside Ø 18 cm, without dishes  
para 2 platos Ø 27 cm, aro interior Ø 18 cm, se entrega sin platos  
pour 2 assiettes maxi Ø 27 cm, anneau intérieur Ø 18 cm, livré sans assiettes

	cm	↑ cm	€
33214	33 x 23,5	30	41,00

**für 3 Teller max. Ø 17 cm, innerer Ring Ø 10,5 cm**  
for 3 plates max. Ø 17 cm, circle inside Ø 10,5 cm  
para 3 platos Ø 17 cm, aro interior Ø 10,5 cm  
pour 3 assiettes maxi Ø 17 cm, anneau intérieur Ø 10,5 cm

	cm	↑ cm	€
33216	22,5 x 16,5	25,5	32,80



**Serviergestell**

servicing stand  
soporte platos  
présentoir à assiettes



**für 3 Teller max. Ø 17 cm, innerer Ring Ø 10,5 cm**  
for 3 plates max. Ø 17 cm, circle inside Ø 10,5 cm  
para 3 platos Ø 17 cm, aro interior Ø 10,5 cm  
pour 3 assiettes maxi Ø 17 cm, anneau intérieur Ø 10,5 cm

	cm	↑ cm	Farbe / Colour	€
33215	18,5 x 15,5	26		25,60
33211	18,5 x 15,5	26		28,00

**für 3 Teller max. Ø 27 cm, innerer Ring Ø 18 cm**  
for 3 plates max. Ø 27 cm, circle inside Ø 18 cm  
para 3 platos Ø 27 cm, aro interior Ø 18 cm  
pour 3 assiettes maxi Ø 27 cm, anneau intérieur Ø 18 cm

	cm	↑ cm	Farbe / Colour	€
33220	29 x 19,5	43		42,00
33212	29 x 19,5	43		45,00



**Etagère „FINESSE“**

etagère  
frutero  
étagère



**vergoldeter Messing-Kugelgriff, einfache Montage**  
gold plated knob, easy to assemble  
botón dorado, fácil de montar  
bouton doré, montage facile

	Ø cm	↑ cm		€
33248	48 / 38 / 32	50	3-stufig / 3-tier 3 alturas / 3 niveaux	99,00
33238	38 / 32	30	2-stufig / 2-tier 2 alturas / 2 niveaux	62,00

## ETAGERES



### Serviergestell, 2-stufig

serving stand, 2-tier  
soporte platos, 2 alturas  
présentoir, 2 hauteurs

3 tlg. Set: 1 Gestell aus Akazienholz, 2 Schieferplatten, zusammenklappbar

3 pcs.: 1 stand acacia wood, 2 slate trays, foldable

set de 3: 1 soporte madera de acacia, 2 bandejas de pizzara, plegable

set de 3: 1 présentoir en bois d'acacia, 2 plateaux en ardoise naturelle, pliable



zusammenklappbar  
foldable

	cm	↑ cm	€/ set
00958	36,5	34 x 26,5	38,80



### High Tea Rack

High Tea Rack  
rack de té alto  
étagère à thé avec anse supérieure

Rubberwood dunkelbraun, Edelstahlgriff, 4 große Fächer 15 x 10 x 10 cm, 3 kleine Fächer 9,5 x 9,5 x 10 cm

rubber wood in dark brown, stainless handle, 4 big compartments 15 x 10 x 10 cm, 3 small compartments 9,5 x 9,5 x 10 cm

madera marrón oscura, mango de acero inoxidable, 4 compartimentos grandes 15 x 10 x 10 cm, 3 compartimentos pequeños 9,5 x 9,5 x 10 cm

bois marron foncé, poignée en acier inox, 4 compartiments grands 15 x 10 x 10 cm, 3 compartiments petits 9,5 x 9,5 x 10 cm



	cm	↑ cm	€
33210	34 x 10	38	40,00



Hygieneschutz  
11557 / 11558

79553

### Brezel- oder Wurstständer

pretzel-/ sausage stand  
soporte para pretzels/ embutidos  
support à bretzel ou à saucissons

Verkaufsständer Buchenholz versiegelt, bestens geeignet für die Präsentation von Brezeln, Würstchen, etc., Fuß Ø 22 cm

beech wood, ideal to present pretzels, sausages, etc., base Ø 22 cm

soporte de madera de haya, ideal para presentar pretzels, salchicas, etc., base Ø 22 cm

support en bois de hêtre, pour la présentation de bretzels, saucisses, etc. pied Ø 22 cm



	Ø cm	↑ cm	€
79553	28	50	21,00

Hygieneschutz für Brezelständer / hygienic cover / campana higiénica antialiento / pare-haleine

	cm	↑ cm	€
11557	20 x 20 x 20	50	22,00
11558	15 x 20 x 15	50	20,00



inklusive Haube  
including cover

### Hobel für Käse und Schokolade

cheese / choco curler  
rizador para queso y chocolate  
frisette pour fromage et chocolat

3-teilig: Platte Buchenholz versiegelt Ø 22 cm mit senkrechtem Stift

+ Hobel 7 cm + Haube Ø 15 x 10 cm, für Käse und Schokolade

3 pcs.: wooden base Ø 22 cm with vertical bolt + plough 7 cm  
+ cover Ø 15 x 10 cm, for cheese and chocolate

set de 3: base de madera Ø 22 cm, con eje vertical de 7 cm

+ campana Ø 15 x 10 cm, para „rizar“ queso y chocolate

set de 3: base bois Ø 22 cm, axe vertical ht. 7 cm, cloche Ø 15 x ht 10 cm,

pour „friser“ le fromage ou le chocolat



	Ø cm	↑ cm	€
50002	22	15	19,50



### 3-stufige Etagère

3-tier tray  
bandeja con tres alturas  
étagère carré 3 hauteurs

**Naturschieferplatte, Akazienholz**

natural slate tray, wood akazie  
bandeja de pizarra natural, madera de acacia  
plateau ardoise naturelle, bois d'acacia



	∅ cm	↑ cm	* mm	€
00960	30 / 25 / 20	34	6 - 9	30,00



### 2-stufige Etagère

2-tier tray  
bandeja dos alturas  
étagère carré 2 hauteurs

**Naturschiefer**

natural slate tray  
bandeja de pizarra natural  
plateau ardoise naturelle



	∅ cm	↑ cm	* mm	€
00989	25 / 20	24	6 - 9	15,30

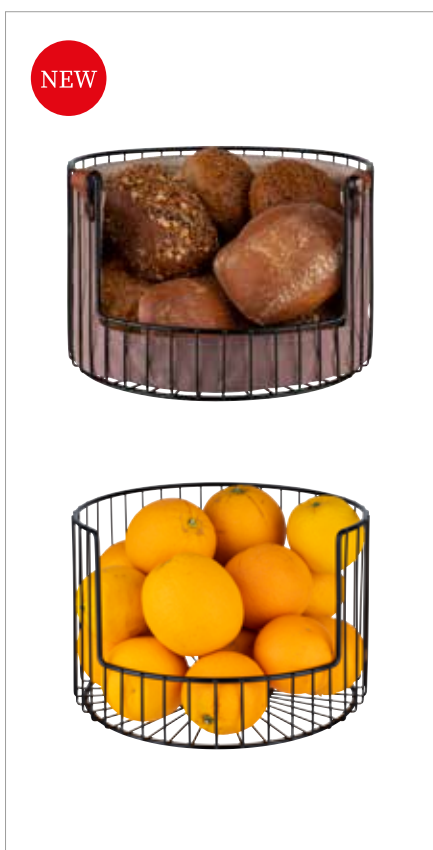

### Brot- und Obstkorb

basket for bread or fruits  
cesta para pan o fruta  
corbeille à pain ou à fruits



**inklusive Tasche aus Baumwolle, beige grau, maschinenwaschbar bis 30 Grad**

incl. bag made of cotton, beige, grey, machine washable up to 30°C  
bolsa incluida, de algodón, beige, gris, lavable a máquina hasta 30°C  
sac inclus en coton, beige, gris, lavable en machine jusqu'à 30°C

	∅ cm	↑ cm	€
30209	27,5	18,5	29,00



stapelbar  
stackable

rutschfest inklusive Klipp  
non-slip, includes clip

# ETAGERES



## 2-stufige Etagère „IRON“

2-tier tray  
bandeja con dos alturas  
étagère carré 2 hauteurs

- 1 Gestell aus schwarzem Metall
- 2 Akazienholzplatten: Ø 23 cm, H: 1,5 cm / Ø 30 cm, H: 2,5 cm
- 2 Beschriftungsschilder 15 x 10,5 cm

- 1 soporte metálico negro
- 2 tablas de madera de acacia: Ø 23 cm, H: 1,5 cm / Ø 30 cm, H: 2,5 cm
- 2 etiquetas de inscripción 15 x 10,5 cm

- 1 support métallique noir
- 2 panneaux en bois d'acacia: Ø 23 cm, H: 1,5 cm / Ø 30 cm, H: 2,5 cm
- 2 étiquettes d'inscription 15 x 10,5 cm



	cm	↑ cm	€/ set
30334	47 x 30	44	80,00

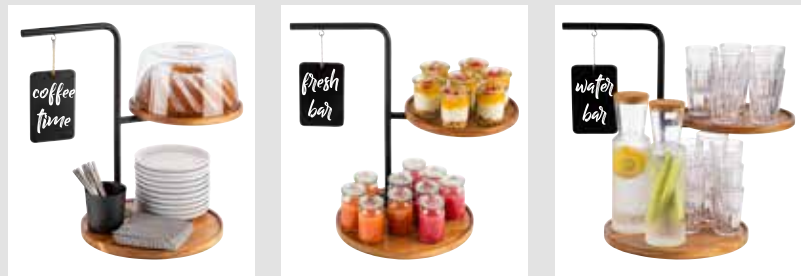

Präsentationsmöglichkeiten  
presentation examples



## 2-stufige Etagère

2-tier tray  
soporte 2 alturas  
étagère 2 niveaux

- 1 Gestell aus Metall schwarz, mit Antirutschfüßchen,
- 2 herausnehmbare Bretter aus geöltem Akazienholz (34,5 x 20,5 x 1,5 cm) / (34,5 x 13 x 1,5 cm)
- 8 Beschriftungsschilder (8 x 4 cm)

- 1 frame made of black metal with non-slip feet,
- 2 removable trays made of acacia wood (34,5 x 20,5 x 1,5 cm) / (34,5 x 13 x 1,5 cm)
- 8 labelling plates (8 x 4 cm)

- 1 soporte metálico, negro con pies antideslizantes,
- 2 bandejas extraíbles de madera de acacia (34,5 x 20,5 x 1,5 cm) / (34,5 x 13 x 1,5 cm)
- 8 etiquetas (8 x 4 cm)

- 1 support métallique noir avec pieds antidérapants,
- 2 planches amovibles en bois d'acacia (34,5 x 20,5 x 1,5 cm) / (34,5 x 13 x 1,5 cm)
- 8 étiquettes (8 x 4 cm)



	cm	↑ cm	€/ set
30339	35,5 x 21	40	59,00



Präsentationsmöglichkeiten  
presentation examples



mit Antirutschfüßchen  
with non-slip feet

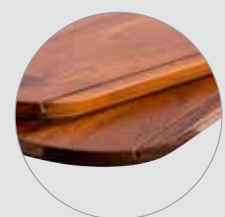

geöltes Akazienholz  
oiled acacia wood





1 x Gestell / 1 x frame



2 x Korb / 2 x basket

5 tlg.  
5 pcs.



2 x Tablett / 2 x tray



Haube / cover 11056



Korb / basket 30337



Tablett / tray 85099



Tablett / tray 30338

## 2-stufige Etagère „ALL-ROUNDER“, 5-teilig

2-tier tray, 5 pcs.

soporte 2 alturas, set de 5

étagère 2 niveaux, set de 5

5 teiliges Set:

- 1 Gestell aus Metall schwarz, mit Antirutschfüßchen,
- 2 Körbe aus Metall schwarz je 29 x 16 cm, H: 7 cm,
- 2 herausnehmbare Bretter aus geöltem Akazienholz je 28,5 x 15,5 cm, H: 1,5 cm

5 pcs.:

- 1 frame made of black metal with non-slip feet,
- 2 baskets of black metal each 29 x 16 cm, H: 7 cm,
- 2 boards of oiled acacia wood each 28,5 x 15,5 cm, H: 1,5 cm

set de 5:

- 1 soporte metálico, negro con pies antideslizantes,
- 2 cestas metálicas negras, cada una de 29 x 16 cm, H: 7 cm,
- 2 tablas de madera de acacia aceiteada 28,5 x 15,5 cm, H: 1,5 cm

set de 5:

- 1 support métallique noir avec pieds antidérapants,
- 2 paniers métalliques noirs, chacune 29 x 16 cm, H: 7 cm,
- 2 planches d'acacia huilé, chacune 28,5 x 15,5 cm, H: 1,5 cm



	cm	↑ cm	€ / set
30336	31 x 17	37,5	64,00

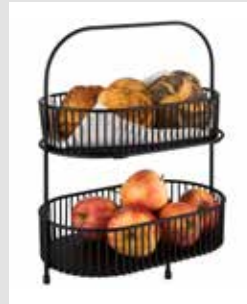

multifunktional,  
ideal als

- Frühstücks-Etagère
- Vorspeisen-Etagère
- Kuchen-Etagère
- Brot-Etagère
- Gebäck-Etagère
- Früchte-Etagère

Präsentationsmöglichkeiten  
presentation examples



geöltes Akazienholz  
oiled acacia wood



mit Antirutschfüßchen  
with non-slip feet

Korb / basket / cesta / corbeille

	cm	↑ cm	Farbe / Colour	€
30337	29 x 16	7	■	19,00

Servierbrett aus Akazienholz / serving board of acacia wood / tabla de servio de madera de acacia / planche de service en bois d'acacia

	cm	↑ cm	Farbe / Colour	€
30338	28,5 x 15,5	3,5	■	7,60

Melamintablett / melamine tray / bandeja de melamina / plateau en mélamine

	cm	↑ cm	Farbe / Colour	€
85099	28,0 x 15,5	1,0	■	13,60

Haube / cover / campana / cloche

	cm	↑ cm	€
11056	26,0 x 12,0	10,0	6,00

## ETAGERES



### Etagère, 2-stufig

2-tier tray  
bandeja 2 alturas  
étagère carré 2 hauteurs

**Gestell aus Eichenholz (geölt)**

oak wood frame (oiled)  
marco de madera de roble (aceitada)  
structure en bois du chêne (huilé)



	cm	↑ cm	fits to	€
14010	35 x 26,5	44,5	GN 1/2, 1/3	160,00
14011	55,5 x 26,5	44,5	GN 2/4	184,00



### Etagère, 3-stufig

3-tier tray  
bandeja 3 alturas  
étagère carré 3 hauteurs

**Gestell aus Eichenholz (geölt)**

oak wood frame (oiled)  
marco de madera de roble (aceitada)  
structure en bois du chêne (huilé)



	cm	↑ cm	fits to	€
14012	55,5 x 32,5	64	GN 1/1, 2/4	240,00



### Etagère, 2+3-stufig, rund

2+3-tier tray, round  
bandeja 2+3 alturas, en torno a  
étagère carré 2+3 hauteurs, rond

**Gestell aus Eichenholz (geölt)**

oak wood frame (oiled)  
marco de madera de roble (aceitada)  
structure en bois du chêne (huilé)



	Ø cm	↑ cm	€
14013	30	28	66,00
14014	30	42	84,00



**Buffetständer „ACACIA“**

buffet stand  
soporte para buffet  
présentoir buffet

Akazienholz geölt / acacia wood oiled / madera de acacia aceitada / bois d'acacia huilé



	Ø cm	↑ cm		€
15620	20,0	10,5		29,00
15621	30,5	15,0		51,00
15622	30,5	20,0		55,00

**Frischhaltehaube / cover / campana / cloche**



	Ø cm	↑ cm	fits to	€
06520	30	22	15621, 15622	37,00

**Frischhaltehaube / cover / campana / cloche**



	Ø cm	↑ cm	fits to	€
06512	30	11,5	15621, 15622	8,20



**Buffetständer „ACACIA“**

buffet stand  
soporte para buffet  
présentoir buffet

Akazienholz geölt / acacia wood oiled / madera de acacia aceitada / bois d'acacia huilé



	cm	↑ cm	GN	€
15623	53 x 16,2	20	2/4	60,00



**GN Abdeckhaube / GN cover / GN campana/ GN cloche**

	cm	↑ cm	GN	€
11044	53 x 16,2	10,5	2/4	23,00

# CUTTING BOARDS



00954  
Box

00953  
Schneidebrett

83615  
Tablett



## Tablett „BROTSTATION“

tray  
bandeja  
plateau

mit Antirutschfüßchen  
with non-slip feet  
con pies antideslizantes  
avec pieds antidérapants



	cm	↑ cm	€
83615	59,5 x 35,5	3,5	42,00

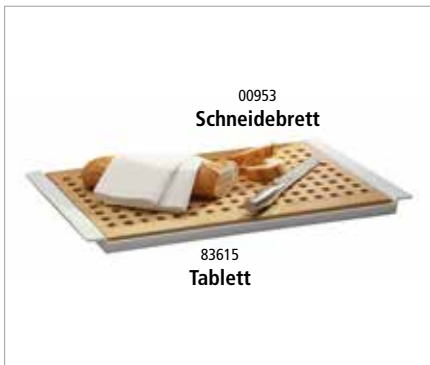

00953  
Schneidebrett

83615  
Tablett

## Brotschneidebrett „BROTSTATION“

cutting board  
tabla de corte  
planche à découper

Buchenholz  
beech  
haya  
hêtre



	cm	↑ cm	€
00953	52 x 34	2	37,00

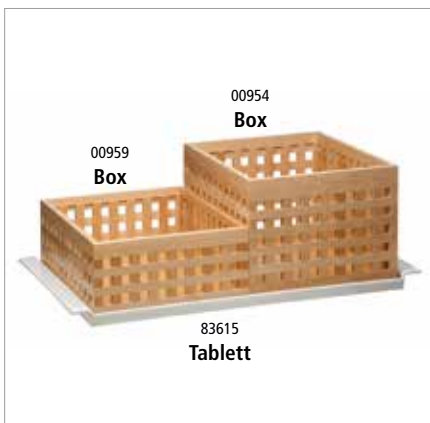

00954  
Box

00959  
Box

83615  
Tablett

## Box „BROTSTATION“

box  
caja de pan  
boîte à pain

Buchenholz  
beech  
haya  
hêtre



	cm	↑ cm	€
00959	34 x 26	12,5	48,00
00954	34 x 26	20,0	59,00



**Brotschneidebrett „PROFI“**

cutting board  
tabla de cortar  
planche à découper



Eichenholz / oak wood / mader de roble / bois de chêne

	cm	↑ cm		€
00806	58 x 37,5	4		110,00



**Brotschneidebrett**

cutting board  
tabla de cortar  
planche à découper



Walnussholz / walnut wood / mader de nogal / bois de noyer

	cm	↑ cm	GN	€
00911	35,4 x 32,5	3,5	2/3	77,00

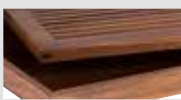

praktisches Krümfach  
practical crump shelf



praktisches Krümfach  
practical crump shelf

**Brotschneidebrett „LETTER“**

cutting board  
tabla de cortar  
planche à découper



Akazienholz / acacia wood / mader de acacia / bois d'acacia

	cm	↑ cm		€
00886	48 x 34	3,5		34,00



00885

**Brotschneidebrett**

cutting board  
tabla de cortar  
planche à découper



Akazienholz / acacia wood / mader de acacia / bois d'acacia

	cm	↑ cm	GN	€
00883	47,5 x 32,0	2		30,00
00884	53,0 x 32,5	2	1/1	31,00
00885	60,0 x 40,0	2		36,00



praktisches Krümfach  
practical crump shelf



00957

**Brotschneidebrett**

cutting board  
tabla de cortar  
planche à découper



Rubberwood / rubberwood / mader de caucho / bois d'hévéa

	cm	↑ cm	GN	€
00955	47,5 x 32,0	2		27,00
00956	53,0 x 32,5	2	1/1	29,00
00957	60,0 x 40,0	2		34,00



praktisches Krümfach  
practical crump shelf



# CUTTING BOARDS



NEW

00762

85225

## Schneidebrett

cutting board  
tabla de cortar  
planche à découper

**Eichenholz, geölt, mit Antirutsch-Füßchen**

oak wood oiled, with non-slip feet  
madera de roble aceitada, con pies antideslizantes  
bois de chêne huilé, avec pieds antidérapants



	cm	↑ cm	Farbe / Colour	€
00762	58,5 x 35	2		72,00

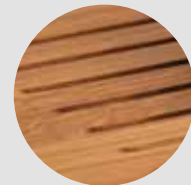

Eichenholz  
oak wood

Präsentationsmöglichkeit / presentation example



NEW

00763

85225

## Schneidebrett

cutting board  
tabla de cortar  
planche à découper

**Walnuss, geölt, mit Antirutsch-Füßchen**

walnut wood oiled, with non-slip feet  
madera de nogal aceitada, con pies antideslizantes  
bois noyer huilé, avec pieds antidérapants



	cm	↑ cm	Farbe / Colour	€
00763	58,5 x 35	2		90,00

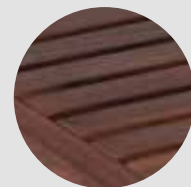

Walnuss  
walnut wood

Präsentationsmöglichkeit / presentation example



NEW

## Tablett / Basis

tray / base  
bandeja / base  
plateaux / base

**Melamin, schwarz, mit Antirutsch-Füßchen, passendes Schneidebrett Nr. 762, 763**

melamine, black, with non-slip feet, suitable cutting board art. 762, 763  
melamina, negro, con pies antideslizantes, tabla de cortar adecuada art. 762, 763  
mélamine, noir, avec pieds antidérapants, planche à découper appropriées art. 762, 763



	cm	↑ cm	€
85225	67 x 38	4	75,00



**Dressingtopf / Flaschenkühler „FROSTFIRE“**

dressing pot / bottle cooler  
salsera / enfriador de botella  
pot à sauce / rafraîchisseur



Antihafbeschichtung / non stick coating / antiadherente / revêtement anti-adhésif

	Ø cm	↑ cm	ltr.	Farbe / Colour	€
36140	11,5 / 11	15	1,5	black/silver	16,00



auch als Flaschenkühler verwendbar  
also usable as a bottle cooler



**Dressingtopf-Display / -Station**

wooden station for 3 dressing pots  
expositor de madera para 3 salseras  
présentoir en bois pour 3 pots à sauce



inklusive 3 Beschriftungsschilder aus Metall / including 3 metal labels / con 3 etiquetas de metal / avec 3 étiquettes métalliques

	cm	↑ cm	fits to	€
84863	40 x 16	9	83311, 83867	31,00



**Dressingtopf „PASTELL“**

dressing pot  
salsera  
pot à sauce



	cm	↑ cm	ltr.	Farbe / Colour	€
84862	13	19,5	1,5	green	22,00
84860	13	19,5	1,5	white	22,00

Beschriftungsetiketten, 72 Stück / labeling labels, 72 pcs. / etiquetas, 72 pzs / étiquettes, 72 pcs.

	cm	Farbe / Colour	€
00069	8 x 4,6	black	10,00



mit Antirutschfüßchen  
with non-slip feet



stapelbar  
stackable



**Dressingtopf „CASUAL“**

dressing pot  
salsera  
pot à sauce



	cm	↑ cm	ltr.	Farbe / Colour	€
83867	12	21,5	1	white	29,80
83868	12	21,5	1	black	29,80



**Dressingtopf**

dressing pot  
salsera  
pot à sauce



Deckel mit Löffelaussparung / cover notched for spoon / tapa agujereada para el cucharón / couvercle avec espace pour la louche

	Ø cm	↑ cm	ltr.	€
83310	17,0	15	2,0	27,00
83311	13,0	13	0,8	14,80

# SQUARE



## GN 1/1 Buffetbrett „SQUARE“

GN 1/1 buffet board  
GN 1/1 tabla de buffet  
GN 1/1 planche de buffet

aus geöltem Eichenholz  
made of oiled oak wood  
de madera de roble aceitada  
en bois de chêne huilé



	cm	↑ cm	GN	€
00758	53,0 x 32,5	2,5	1/1	46,00

passende Haube / suitable cover / campana adecuada / cloche appropriée

	cm	↑ cm	GN	€
11075	53,0 x 32,5	19	1/1	62,00



Haube fixiert sich auf dem Brett, rutschfest  
cover fixes itself on the board, non-slip



## GN 1/2 Buffetbrett „SQUARE“

GN 1/2 buffet board  
GN 1/2 tabla de buffet  
GN 1/2 planche de buffet

aus geöltem Eichenholz  
made of oiled oak wood  
de madera de roble aceitada  
en bois de chêne huilé



	cm	↑ cm	GN	€
00759	32,5 x 26,5	2,5	1/2	30,00

passende Haube / suitable cover / campana adecuada / cloche appropriée

	cm	↑ cm	GN	€
11073	33 x 28	17	1/2	29,00



Haube fixiert sich auf dem Brett, rutschfest  
cover fixes itself on the board, non-slip



**GN 2/4 Buffetbrett „SQUARE“**

GN 2/4 buffet board  
GN 2/4 tabla de buffet  
GN 2/4 planche de buffet

aus geöltem Eichenholz

made of oiled oak wood  
de madera de roble aceitada  
en bois de chêne huilé



	cm	↑ cm	GN	€
00760	53,0 x 16,2	2,5	2/4	30,00

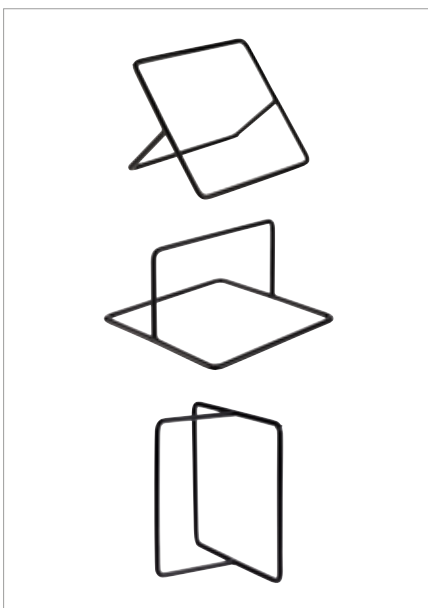

Präsentationsmöglichkeit  
presentation example

**Buffetständer „SQUARE“**

buffet stand  
soporte para buffet  
présentoir buffet

Metall, mit schwarzer Antirutschbeschichtung

metal, with black anti-slide coating  
metal, con revestimiento antideslizante negro  
métal, avec revêtement antidérapant noir



	cm	↑ cm	€
33305	12 x 12	7	6,50



Präsentationsmöglichkeit | presentation example

**Buffetbrett**

buffet board  
tabla de buffet  
planche de buffet

für Karaffen, mit 3 Einsätzen Ø 11 cm aus Kunstleder, aus geöltem Eichenholz

for carafes, with 3 leatherette inserts Ø 11 cm, made of oiled oak wood  
para jarras, con 3 inserciones de imitación de cuero Ø 11 cm, de madera de roble aceitada  
pour pichets, avec 3 inserts en similicuir Ø 11 cm, en bois de chêne huilé



	cm	↑ cm	Farbe / Colour	€
11705	47 x 19	2	 natural oak	82,00
11706	47 x 19	2	 dark oak	82,00

passende Karaffe / suitable carafe / jarra a juego / pichet approprié

	Ø cm	↑ cm	litr.	€
10690	9,5	31	1,0	15,90

6 Einsätze aus Kunstleder / 6 leatherette inserts / 6 inserciones de imitación de cuero / 6 inserts en similicuir

	Ø cm	Farbe / Colour	pcs.	€ / set
35716	11	 anthracite	6	17,00



Kunstledereinsatz herausnehmbar  
removable leatherette insert

# BUFFET BOARDS „PROFI“



**Buffetbrett „PROFI“**  
buffet board  
tabla de buffet  
planche de buffet

aus geöltem Eichenholz, Safrinne, mit Antirutschfüßchen

made of oiled oak, with juice groove and non-slip feet

de madera de roble aceitada, con ranura para líquidos y pies antideslizantes

en bois chêne huilé, avec rigole et pieds antidérapants



	Ø cm	↑ cm	€
00805	33	4,5	68,00
00816	39	4,5	110,00

**Frischhaltehaube / cover / campana / cloche**



	Ø cm	↑ cm	fits to	€
06512	30	11,5	00805	8,20

**Frischhaltehaube / cover / campana / cloche**



	Ø cm	↑ cm	fits to	€
06519	21	17	00815	30,00
06520	30	22	00805	37,00
06521	36	27	00816	74,00



**Buffetbrett „PROFI“**  
buffet board  
tabla de buffet  
planche de buffet

aus geöltem Eichenholz, Safrinne, mit Antirutschfüßchen

made of oiled oak, with juice groove and non-slip feet

de madera de roble aceitada, con ranura para líquidos y pies antideslizantes

en bois chêne huilé, avec rigole et pieds antidérapants



	cm	↑ cm	€
00807	38 x 32,0	4,5	72,00
00806	58 x 37,5	4,5	110,00

**Rolltophaube / rolltop cover / campana rolltop / cloche rolltop**



	Ø cm	↑ cm	fits to	GN	€
11016	53,0 x 32,5	19	00806	1/1	64,00

NEW



4-tlg.  
4 pcs.

11413



5-tlg.  
5 pcs.

11414



11411

Multi Rack

multi rack  
dispensador en escalera  
support multiple



- 1 Gestell schwarz, matt
- Schütten aus grau gefroretem Kunststoff, je ca. 1 Liter
- 1 frame matt
- bowls frosted plastic, approx. 1 liter
- 1 soporte mate
- cuencos de plástico glaseado, aprox. 1 litro
- 1 support mat
- bols en plastique mat, approx. 1 litre

	cm	↑ cm	ltr.	€
11413	19 x 24	41	1	50,00
11414	19 x 31	53	1	64,00

Ergänzung für alle Multi-Racks

supplement for all multi racks  
suplemento para todos los dispensadores  
compléments pour support multi-rack



Schütte / canister / cuenco / bol

	cm	↑ cm	ltr.	€
11411	19,5 x 16,5	10,5	1	7,20



4-tlg.  
4 pcs.

11444



5-tlg.  
5 pcs.

11446



11455

Multi Rack

multi rack  
dispensador en escalera  
support multiple



- 1 Gestell matt poliert
- Schütten aus transparent gefroretem Kunststoff, je ca. 1 Liter
- 1 frame matt polished
- bowls frosted plastic, approx. 1 liter
- 1 soporte pulido mate
- cuencos de plástico glaseado, aprox. 1 litro
- 1 support poli mat
- bols en plastique mat, approx. 1 litre

	cm	↑ cm	ltr.	€
11444	19 x 24	41		48,00
11446	19 x 31	53		62,00

Ergänzung für alle Multi-Racks

supplement for all multi racks  
suplemento para todos los dispensadores  
compléments pour support multi-rack



Schütte / canister / cuenco / bol

	cm	↑ cm	ltr.	€
11455	19,5 x 16,5	10,5	1,0	7,20

# JARS



82255 1,0 ltr.



82256 2,0 ltr.



82257 2,5 ltr.

## Vorratsglas „WOODY“

jar with lid  
bote con tapa  
pot en verre avec couvercle



Glasbehälter mit Holzdeckel, aromadichter Verschluss

glass container, aroma-tight screw cap

recipiente de cristal, tapa con cierre hermético para conservar el aroma

réceptien en verre, couvercle avec fermeture hermétique pour conserver l'arôme

	cm	↑ cm	ltr.	€
82255	14 x 14	11,0	1,0	11,50
82256	14 x 14	17,0	2,0	12,60
82257	14 x 14	21,5	2,5	14,40



Holzdeckel aus Kiefernholz mit Silikondichtung  
wooden lid from pine wood with silicone gasket



82265 1 ltr.

82266 1,2 ltr.



82267 1,5 ltr.

## Vorratsglas

jar with lid  
bote con tapa  
pot en verre avec couvercle



inklusive Glasdeckel mit Dichtung und Beschriftungsfeld, somit bleibt Ihre Ware frisch

including glass lid with seal and labeling field, thus, your goods remain fresh

con tapa de vidrio con junta y campo de etiquetado, por lo tanto, sus productos permanecen frescos

y compris couvercle en verre avec joint et le domaine de l'étiquetage, ainsi, vos marchandises restent fraîches

	Ø cm	↑ cm	ltr.	€
82265	11,0	18,0	1,0	7,60
82266	11,5	19,5	1,2	8,50
82267	12,0	21,0	1,5	11,20



71490

Kreidestift zum Beschriften | chalk marker for writing  
S. 346



82250 0,9 ltr.



82251 2 ltr.



82252 4 ltr.



82253 6 ltr.

Vorratsglas „CLASSIC“

jar with lid  
bote con tapa  
pot en verre avec couvercle

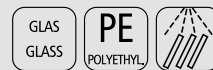

inklusive Glasdeckel mit Dichtung, somit bleibt Ihre Ware frisch

including glass lid with seal, thus, your goods remain fresh

con tapa de vidrio con junta, por lo tanto, sus productos permanecen frescos

y compris couvercle en verre avec joint, ainsi, vos marchandises restent fraîches

	Ø cm	↑ cm	ltr.	€
82250	11,5	16,0	0,9	7,80
82251	14,0	21,5	2,0	13,20
82252	18,0	26,0	4,0	21,60
82253	20,0	30,0	6,0	25,40



Präsentationsmöglichkeit  
presentation example



2 ltr.

Vorratsglas mit luftdichtem Klappdeckel

jar with airtight cover  
bote con cierre hermético  
pot en verre avec fermeture hermétique



	cm	↑ cm	ltr.	€
82328	12 x 12	22	2	9,00



**seitlich gestellt**  
placed sideways  
1 ltr.



**hochkant gestellt**  
placed upright  
2,2 ltr.



**Vorratsglas**  
jar with lid  
bote con tapa  
pot en verre avec couvercle

mit Löffel, Schraubdeckel mit aromadichtem Verschluss, Edelstahlöffel  
mit magnetischem Silikongriff

tight cover, stainless steel spoon with magnetic silicone handle  
tapa a rosca con cierre hermético, cuchara de acero inoxidable con mango de silicona magnético  
couvercle à vis avec fermeture hermétique, cuillère en acier inox avec manche de silicone aimanté

GLAS GLASS SILIKON SILICON EDELSTAHL STAINLESS INOX

	cm	↑ cm	ltr.	€
00636	17 x 12,5	18	1 - 2,2	15,00

**seitlich gestellt**  
placed sideways  
1 ltr.



**hochkant gestellt**  
placed upright  
2,2 ltr.

**Vorratsglas**  
jar with lid  
bote con tapa  
pot en verre avec couvercle

mit Schraubdeckel, aromadichtem Verschluss

aroma-tight screw cap  
tapa a rosca para conservar el aroma  
couvercle à vis pour conserver l'arôme

GLAS GLASS EDELSTAHL STAINLESS INOX

	cm	↑ cm	ltr.	€
00637	17 x 12,5	18	1 - 2,2	10,00

**stapelbar**  
stackable

**Frontklappe**  
front lid



11884

11885

**Universalbox**  
box / sweetbox  
caja dispensadora  
boîte distributrice

ideal als Verkaufsbox, mit Frontdeckel

best to present sweets etc., all-purpose, with front lid  
la perfecta solución para presentar golosinas, universal, con tapa frontal  
la solution idéale pour les friandises et autres, universal, avec couvercle frontal

ACRYL ACRYLIC PP POLYPROP. Made in Germany

	cm	↑ cm	Farbe / Colour	€
11884	23 x 14,5	15	White	14,00
11885	23 x 14,5	15	Red	14,00



**Schale, 3er Set „SPHERE“**

bowl, 3 pcs.  
cuenco, set de 3  
bol, set of 3



innen: mattiert / inside: matt / interior: mate / intérieur: mat

	Ø cm	↑ cm	ltr.	Farbe / Colour	pcs.	€ / set
40770	8	7	0,1	gold	3	30,00
40771	8	7	0,1	copper	3	30,00
40772	8	7	0,1	gunmetal	3	30,00



**Schale „SPHERE“**

bowl  
cuenco  
bol



innen: mattiert / inside: matt / interior: mate / intérieur: mat

	Ø cm	↑ cm	ltr.	Farbe / Colour	€
40773	16	15	0,8	gold	24,00
40774	16	15	0,8	gunmetal	24,00



**Schale „SPHERE“**

bowl  
cuenco  
bol



innen: mattiert / inside: matt / interior: mate / intérieur: mat

	Ø cm	↑ cm	ltr.	Farbe / Colour	€
40775	24	21	2	gold	36,00
40776	24	21	2	gunmetal	36,00

NEW

5 STARS



Töpfe aus emailliertem Gusseisen leiten nicht nur die Wärme gut, sondern können sie auch lange energieschonend speichern – ideal für den professionellen Einsatz am Buffet!

Cooking pots made of enamelled cast iron not only conduct heat well, but can also store it for a long time while conserving energy - ideal for professional use at the buffet!

Las ollas de hierro fundido esmaltado no sólo conducen bien el calor, sino que también pueden almacenarlo durante mucho tiempo conservando la energía: ¡ideales para un uso profesional en el buffet!

Les marmites en fonte émaillée ne conduisent pas seulement bien la chaleur, mais peuvent aussi la conserver longtemps en économisant de l'énergie - idéal pour une utilisation professionnelle au buffet!

NEW



88300 2,5 ltr.



88301 2,5 ltr.



88312 2,5 ltr.

**Bräter mit Deckel „5 STARS“**

roaster with lid  
cacerola con tapa  
cocotte avec couvercle



	Ø cm	↑ cm	ltr.	Farbe / Colour	€
88300	25	7 / 13	2,5		59,00
88301	25	7 / 13	2,5		59,00
88312	25	7 / 13	2,5		59,00



88300

inklusive Deckelhalter  
including lid holder



NEW



88302 4 ltr.



88303 4 ltr.



88313 4 ltr.

Kochtopf mit Deckel „5 STARS“  
 cooking pot with lid  
 olla con tapa  
 marmite avec couvercle



	Ø cm	↑ cm	ltr.	Farbe / Colour	€
88302	25	11,5 / 17,5	4		64,00
88303	25	11,5 / 17,5	4		64,00
88313	25	11,5 / 17,5	4		64,00



88302

inklusive Deckelhalter  
 including lid holder

NEW



88304 3 ltr.



88305 3 ltr.



88314 3 ltr.

Bräter mit Deckel „5 STARS“  
 roaster with lid  
 cacerola con tapa  
 cocotte avec couvercle



	Ø cm	↑ cm	ltr.	Farbe / Colour	€
88304	28	7 / 13,5	3		69,00
88305	28	7 / 13,5	3		69,00
88314	28	7 / 13,5	3		69,00



88304

inklusive Deckelhalter  
 including lid holder



**Kochtopf mit Deckel „5 STARS“**

cooking pot with lid  
olla con tapa  
marmite avec couvercle



	Ø cm	↑ cm	ltr.	Farbe / Colour	€
88306	28	13 / 20	6		74,00
88307	28	13 / 20	6		74,00
88315	28	13 / 20	6		74,00



inklusive Deckelhalter  
including lid holder



**Bräter mit Deckel „5 STARS“**

roaster with lid  
cacerola con tapa  
cocotte avec couvercle



	cm	↑ cm	ltr.	Farbe / Colour	€
88308	33 x 25	11 / 17,5	5		79,00
88309	33 x 25	11 / 17,5	5		79,00
88316	33 x 25	11 / 17,5	5		79,00



inklusive Deckelhalter  
including lid holder



**Auflaufform „5 STARS“**

casserole dish  
fuente para gratinar  
plat à four



	cm	↑ cm	ltr.	Farbe / Colour	€
88310	33 x 24	6,5	3,5	Red	54,00
88311	33 x 24	6,5	3,5	Black	54,00
88317	33 x 24	6,5	3,5	Teal	54,00

88310 3,5 ltr.

88311 3,5 ltr.

88317 3,5 ltr.



**Deckelhalter, 2er Set**

lid holder, 2 pcs.

soporte para tapa, set de 2

support de couvercle, set de 2

mit Antirutschbeschichtung, für alle Töpfe mit Deckel einsetzbar, hitzebeständig

with non-slip coating, suitable for all pots with lids, heat-resistant

revestimiento antideslizante, apto para todas las ollas con tapa, resistente al calor

avec revêtement antidérapant, adapté à toutes les casseroles avec couvercle, résistant à la chaleur



	cm	↑ cm	Farbe / Colour	pcs.	€ / set
88320	10,5 x 8,5	3,5	Black	2	10,00



88308 5 ltr.

88315 6 ltr.

88310 3,5 ltr.



88303 4 ltr.

88305 3 ltr.

88312 2,5 ltr.

# CHAFING DISH

4 tlg.  
4 pcs.



12330



12335



12336



12337



12338



12339



82211

## Chafing Dish, 4-teiliges Set

chafing dish set, 4 pcs.  
chafing dish, set de 4  
chafing dish, set de 4



### 4-teiliges Set:

- 1 Topf (8 Liter)
- 1 Speisenbehälter (4 Liter)
- 1 Deckel mit Sichtfenster und 1 Deckelbremse
- Topf mit induktionsfähigem Sandwich- / Kapselboden

### 4 pcs. set:

- 1 pot (8 litres),
- 1 foodpan (4 litres)
- 1 lid with glass insert and 1 automatic lid brake
- pot with induction-compatible sandwich base

### set de 4:

- 1 olla (8 litros)
- 1 cubeta (4 litros)
- 1 tapa con ventanilla y 1 sistema de freno en la tapa
- olla con base sandwich apta para inducción

### set de 4:

- 1 casserole (8 litres)
- 1 bac (4 litres)
- 1 couvercle avec fenêtre et 1 système de frein dans le couvercle
- casserole avec fond sandwich pour induction

	Ø cm	↑ cm	ltr.	Farbe / Colour		€/ set
12330	30,5	17,5	4		stainless	260,00
12335	30,5	17,5	4		copper	314,00
12336	30,5	17,5	4		yellow	314,00
12337	30,5	17,5	4		red	314,00
12338	30,5	17,5	4		black	314,00
12339	30,5	17,5	4		green	314,00

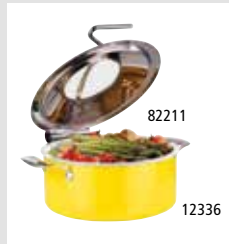

82211

12336



abnehmbarer Deckel  
removable lid

induktionsgeeignet  
suitable for induction

Ersatz-Speisenbehälter zu Chafing Dish / replacement foodpan for chafing dish / cubeta interior de repuesto para chafing dish / bac intérieur de remplacement pour le chafing dish

	Ø cm	↑ cm	ltr.	fits to	€
12329	30,5	8	4	12330, 12335, 12336, 12337, 12338, 12339	30,00



Ø 33 cm



Sandwich- / Kapselboden / sandwich base



Ø 30,5 cm

4 ltr. Speisenbehälter  
4 ltr. foodpan



Deckelbremse  
automatic lid break

## Porzellaneinsatz

porcelain insert  
bandeja de porcelana  
bac en porcelaine



	Ø cm	↑ cm	ltr.	fits to	€
82211	29,5	9	3	12330, 12335, 12336, 12337, 12338, 12339	62,00



Die Induktionsstation mit Regler präsentiert sich in einem Set aus Eiche, einem schwarzen Metallständer und einer Induktionsheizung.

The induction station with controller is presented in a set of oak, a black metal stand and an induction heater.

La estación de inducción con regulador se presenta en un set formado por una caja de madera de roble, un soporte de metal negro y un calentador de inducción.

La station à induction avec température réglable se compose d'un caisson en bois de chêne, d'un support métallique noir et d'une plaque à induction.



**Induktionsstation, 4-tlg. Set**

induction station, 4 pcs.  
estación de inducción, set de 4  
station d'induction, set de 4

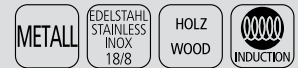

4 teiliges Set:

- 1 Induktionskochplatte mit Regler (Ø 24 cm, 900 Watt)
- 1 Metallständer schwarz
- 1 Rahmen aus Eiche (wasserfest lackiert)
- 1 Edelstahlrahmen

4 pcs. set:

- 1 induction hotplate with controller (Ø 24 cm, 900 watt)
- 1 metal stand black
- 1 frame made of oak (water-resistant coated)
- 1 stainless steel frame

set de 4:

- 1 placa de inducción con regulador (Ø 24 cm, 900 vatios)
- 1 soporte de metal negro
- 1 caja de roble (con recubrimiento resistente al agua)
- 1 marco de acero inoxidable

set de 4:

- 1 plaque d'induction avec température réglable (Ø 24 cm, 900 watts)
- 1 support métallique noir
- 1 cadre en chêne (verni résistant à l'eau)
- 1 cadre en acier inox

	cm	↑ cm	€
12275	35,4 x 32,5	19	224,00



passendes Chafing Dish Set 12339  
suitable chafing dish set 12339

Ersatzteile / replacement parts / piezas de repuesto / pièces de rechange

	cm	↑ cm		€
12276	35,4 x 32,5	8,5	Holzrahmen / wooden frame	72,00
12272	29,5 x 26,5	1	Edelstahlrahmen / stainless steel frame	22,00
12295	Ø 24	-	900 Watt Induktionskochplatte / induction plate	139,00
15506	35,4 x 32,5	17,6	Buffetständer schwarz / buffet stand black	22,80

# NAPKIN HOLDERS



## Serviettenhalter

napkin holder  
servilletero  
porte-serviettes



hochglanzpoliert, für Servietten mit 1/8 Falz, FüÙe mit rutsch- und kratzfester Gummierung  
mirror polished, for napkins with 1/8 fold, feet with non-slip and scratch-resistant rubber coating

pulido brillante, para servilletas plegado 1/8, pies con revestimiento de goma antideslizante y anti rayaduras

poli brillant, pour serviettes pliage 1/8, pieds avec caoutchouc antidérapant et antirayures

	cm	↑ cm	€
11720	10 x 11,5	18,5	12,40



11767

11768

## Serviettenhalter „HERO“

napkin holder  
servilletero  
porte-serviettes



für ca. 65 Cocktailservietten, inklusive Beschwerer

for approx. 65 cocktail napkins, including weight

para aprox. 65 servilletas cocktail, con barra de contrepeso

pour environ 65 serviettes cocktail, avec barre de contrepoids

	cm	↑ cm	€
11767	14,5 x 14,5	10	11,00

für ca. 95 Servietten 1/4 Falz, inklusive Beschwerer

for approx. 95 napkins 1/4 fold, including weight

para aprox. 95 servilletas de plegado ¼, con barra de contrepeso

pour environ 95 serviettes pliage ¼, avec barre de contrepoids

	cm	↑ cm	€
11768	18,5 x 18,5	14	14,00



inklusive Beschwerer  
including weight



11770



11771

**Serviettenhalter „URBAN“**

napkin holder  
servilletero  
porte-serviettes



**für ca. 50 Servietten ¼ Falz, inklusive Beschwerer**

for approx. 50 napkins ¼ fold, including weight  
para aprox. 50 servilletas de plegado ¼, con barra de contrapeso  
pour environ 50 serviettes pliage ¼, avec barre de contrepoids

	cm	↑ cm	€
11770	19 x 19	7,5	11,00

**für ca. 120 Servietten ¼ Falz, inklusive Beschwerer**

for approx. 120 napkins ¼ fold, including weight  
para aprox. 120 servilletas de plegado ¼, con barra de contrapeso  
pour environ 120 serviettes pliage ¼, incl. barrie de contrepoids

	cm	↑ cm	€
11771	19 x 19	18	14,50



**inklusive Beschwerer**  
including weight



11762



11763



11765

**Serviettenhalter „WIRE“**

napkin holder  
servilletero  
porte-serviettes



**für ca. 50 Cocktailservietten, inklusive Beschwerer**

for approx. 50 cocktail napkins, including weight  
para aprox. 50 servilletas cocktail, con barra de contrapeso  
pour environ 50 serviettes cocktail, avec barre de contrepoids

	cm	↑ cm	€
11762	14 x 14	6,5	6,90

**für 50 Servietten 1/4 Falz, inklusive Beschwerer**

for 50 napkins 1/4 fold, including weight  
para 50 servilletas plegado 1/4, con barra de contrapeso  
pour 50 serviettes pliage 1/4, avec barre de contrepoids

	cm	↑ cm	€
11763	19 x 19	6,5	7,20

**für 150 Servietten 1/4 Falz, inklusive Beschwerer**

for 150 napkins 1/4 fold, including weight  
para 150 servilletas plegado 1/4, con barra de contrapeso  
pour 150 serviettes pliage 1/4, avec barre de contrepoids

	cm	↑ cm	€
11765	19 x 19	19,0	11,80



**inklusive Beschwerer**  
including weight

## NAPKIN HOLDERS



### Serviettenhalter

napkin holder  
servilletero  
porte-serviettes



für ca. 20 Servietten, matt poliert, möbelschonende Unterseite,  
for approx. 20 napkins, matt polished, furniture-friendly underside  
para aprox. 20 servilletas, pulido mate, con base anti rayaduras  
pour environ 20 serviettes, poli mat, avec revêtement antirayures

	cm	↑ cm	€
11778	17 x 3	7	7,00



### Serviettenhalter

napkin holder  
servilletero  
porte-serviettes



für ca. 30 Servietten, matt poliert, möbelschonende Unterseite  
for approx. 30 napkins, matt polished, furniture-friendly underside  
para aprox. 30 servilletas, pulido mate, con base anti rayaduras  
pour environ 30 serviettes, poli mat, avec revêtement antirayures

	cm	↑ cm	€
11780	15 x 4,5	12,5	8,00



### Serviettenhalter „ELEMENT“

napkin holder  
servilletero  
porte-serviettes



für ca. 50 Servietten, möbelschonende Unterseite  
for approx. 50 napkins, furniture-friendly underside  
para aprox. 50 servilletas, con base anti rayaduras  
pour environ 50 serviettes, avec revêtement antirayures

	cm	↑ cm	€
11781	16 x 7,5	10	10,00



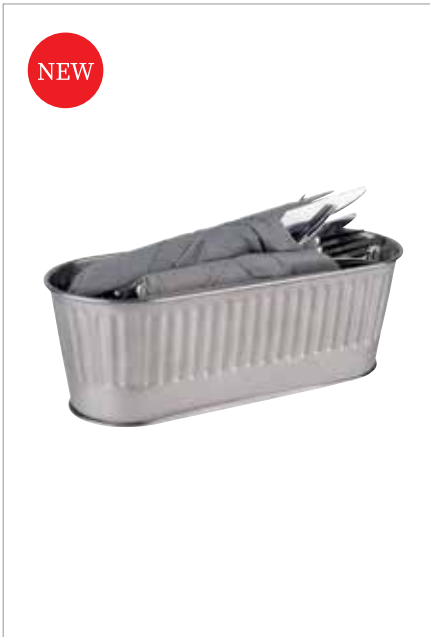

NEW

**Besteckbehälter / Korb**  
 cutlery bin / basket  
 porta cubiertos / cesta  
 range-couverts / corbeille  
**matt poliert, Boden: 29 x 8,5 cm**  
 matt polished, base: 29 x 8,5 cm  
 pulido mate, base: 29 x 8,5 cm  
 poli mat, fond: 29 x 8,5 cm



	cm	↑ cm	ltr.	Farbe / Colour	€
11752	29,5 x 12	10	2		11,50



Präsentationsmöglichkeit  
 presentation example



NEW

**Besteckbehälter / Korb**  
 cutlery bin / basket  
 porta cubiertos / cesta  
 range-couverts / corbeille  
**Boden: 29 x 8,5 cm**  
 base: 29 x 8,5 cm  
 base: 29 x 8,5 cm  
 fond: 29 x 8,5 cm



	cm	↑ cm	ltr.	Farbe / Colour	€
11753	29,5 x 12	10	2		13,00



Präsentationsmöglichkeit  
 presentation example

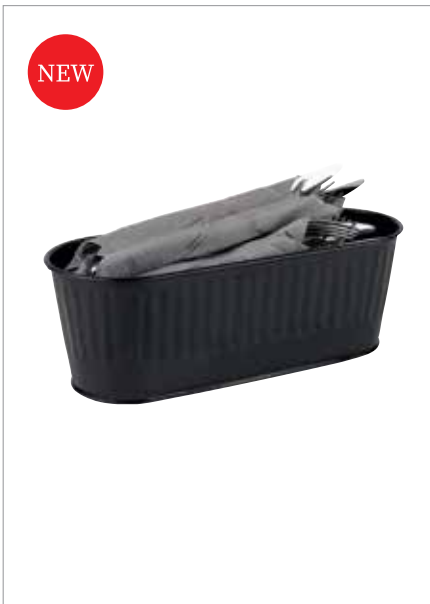

NEW

**Besteckbehälter / Korb**  
 cutlery bin / basket  
 porta cubiertos / cesta  
 range-couverts / corbeille  
**Boden: 29 x 8,5 cm**  
 base: 29 x 8,5 cm  
 base: 29 x 8,5 cm  
 fond: 29 x 8,5 cm



	cm	↑ cm	ltr.	Farbe / Colour	€
11754	29,5 x 12	10	2		13,00



Präsentationsmöglichkeit  
 presentation example

## CUTLERY BOXES



### Besteckbehälter

cutlery box  
recipiente para cubiertos  
réceptif pour couverts

**Akazienholz, 4 Fächer (26 x 11,5 cm)**

acacia wood, 4 compartments (26 x 11,5 cm)  
madera de acacia, 4 compartimentos (26 x 11,5 cm)  
bois d'acacia, 4 compartiments (26 x 11,5 cm)



	cm	↑ cm	Farbe / Colour		€
11952	51 x 28	13		nature	50,00
11951	51 x 28	13		vintage white	50,00



### Besteckbehälter mit Deckel

cutlery box with cover  
caja de cubiertos con tapa  
range-couverts avec couvercle

**Akazienholz, 4 Fächer (26 x 11,5 cm), mit Deckel**

acacia wood, 4 compartments (26 x 11,5 cm), with cover  
madera de acacia, 4 compartimentos (26 x 11,5 cm), con tapa  
bois d'acacia, 4 compartiments (26 x 11,5 cm), avec couvercle



	cm	↑ cm	Farbe / Colour		€
11949	51 x 28	14,5		nature	74,00
11948	51 x 28	14,5		vintage white	70,00



### GN 1/1 Besteckbehälter

GN 1/1 dispenser GN  
GN 1/1 dispensador de cubiertos  
GN 1/1 bac à couverts

**in Handarbeit geflochten, 4 Mulden, Kunststoff-Geflecht, Drahtgestell, braun-schwarz**

hand-woven, 4 troughs, plastic wickerwork, wire frame, brown-black  
cesta trensada a mano, 4 compartimentos, mimbre de plástico, marco de alambre, marrón-negro  
corbeille tressée à main, 4 compartiments, plastique tressé, armature en fil métallique, brun-noir



	cm	↑ cm	Farbe / Colour		GN	€
11966	53 x 32,5	9			1/1	41,00



### GN 1/1 Besteckbehälter

GN 1/1 cutlery dispenser  
GN 1/1 dispensador de cubiertos  
GN 1/1 bac à couverts

**4 Mulden, Kunststoff-Geflecht, Drahtgestell, beige**

4 troughs, plastic wickerwork, wire frame, beige  
4 compartimentos, mimbre de plástico, marco de alambre, beige  
4 compartiments, plastique tressé, structure métallique, beige



	cm	↑ cm	Farbe / Colour		GN	€
11965	53 x 32,5	10			1/1	27,40



**GN 1/1 Besteckbehälter**

GN 1/1 cutlery bin  
GN 1/1 recipiente para cubiertos  
GN 1/1 récipients pour couverts



**4 Mulden**

4 troughs  
4 compartimentos  
4 compartments

	cm	↑ cm	Farbe / Colour	GN	€
11954	53 x 32,5	10	■	1/1	7,50
11955	53 x 32,5	10	■	1/1	7,50

**3 Mulden, 3 Köcher**

3 troughs, 3 cutlery baskets  
3 compartimentos, 3 cestas para cubiertos  
3 compartments, 3 corbeilles à couverts

	cm	↑ cm	Farbe / Colour	GN	€
11960	53 x 32,5	10	■	1/1	7,50



**Besteckbehälter**

cutlery basket  
recipiente para cubiertos  
récipients pour couverts



**4 Löcher inklusive 4 Edelstahl Köcher**

4 holes including 4 stainless baskets  
4 agujeros con 4 cestas de acero inoxidable  
4 trous avec 4 corbeilles en acier inox

	cm	↑ cm	Farbe / Colour	€
93321	27 x 27	15	■	79,00



**Besteckköcher**

cutlery basket  
cesta para cubiertos  
corbeille à couverts



Polyethylen weiß / polyethylene white plastic / polietileno blanco / polyéthylène blanc

	Ø cm	↑ cm	€
11998	9,5	13,5	2,90

Edelstahl matt poliert / stainless steel matt polished / acero inoxidable pulido mate / acier inox poli mat

	Ø cm	↑ cm	€
11999	9,5	13,5	8,00



**Besteckkasten „INDUSTRIAL“**

cutlery box  
caja para cubiertos  
boîte pour couverts



**Metall, schwarz**

metal, black  
metal, negro  
métal, noir

	cm	↑ cm	litr.	€
40676	23,0 x 15,5	13,0	2,4	15,20

# BUFFET STANDS

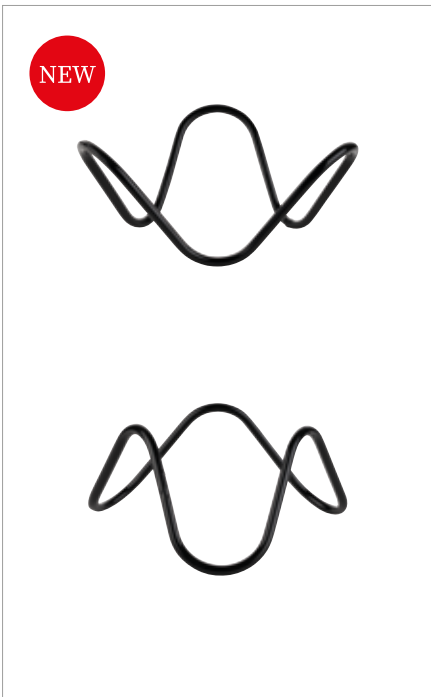

**NEW**

## Buffetständer „WAVE“

buffet stand  
 sorte de buffet  
 support de buffet  
 mit Antirutschbeschichtung  
 with non-slip coating  
 con revestimiento antideslizante  
 avec revêtement antidérapant



	Ø cm	↑ cm	€
33306	20	9,5	10,00



Präsentationsmöglichkeit  
 presentation example

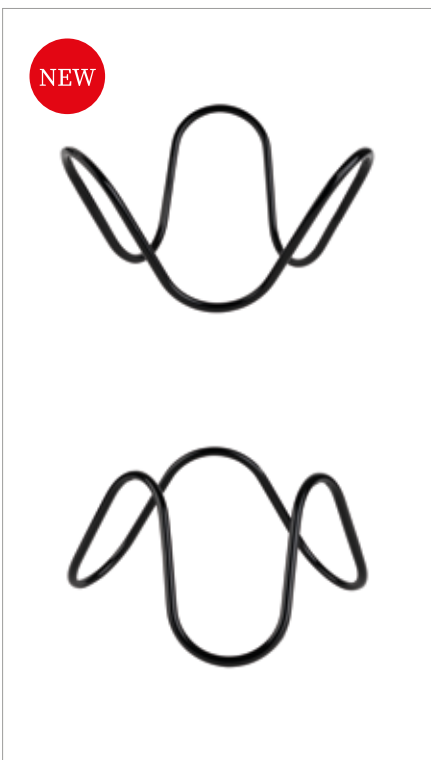

**NEW**

## Buffetständer „WAVE“

buffet stand  
 sorte de buffet  
 support de buffet  
 mit Antirutschbeschichtung  
 with non-slip coating  
 con revestimiento antideslizante  
 avec revêtement antidérapant



	Ø cm	↑ cm	€
33307	24	13	12,00

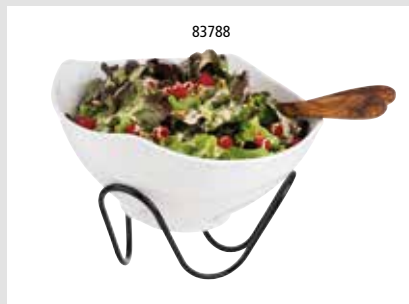

Präsentationsmöglichkeit  
 presentation example



**Buffetständer „STAR“**

buffet stand  
soporte para buffet  
présentoire buffet

**Metall, mit schwarzer Antirutschbeschichtung**

metal, with black anti-slide coating  
metal, con revestimiento antideslizante negro  
métal, avec revêtement antidérapant noir



	↑ cm	€
33260	8	14,80
33261	12	17,50
33262	18	20,00



**Buffetständer „MULTI“**

buffet stand  
soporte para buffet  
présentoir buffet

**Metall, mit schwarzer Antirutschbeschichtung**

metal, with black anti-slide coating  
metal, con revestimiento antideslizante negro  
métal, avec revêtement antidérapant noir



	Ø cm	↑ cm	€
33269	15,5 / 18	8	10,90
33270	15,5 / 18	10	13,00
33271	15,5 / 18	18	16,70

	cm	↑ cm	€
33249	18 x 18	5	9,60
33250	18 x 18	8	3,00
33251	18 x 18	10	16,00
33252	18 x 18	18	18,90



**Buffetständer „PRISMA“**

buffet stand  
soporte para buffet  
présentoir buffet

**Metall, mit schwarzer Antirutschbeschichtung**

metal, with black anti-slide coating  
metal, con revestimiento antideslizante negro  
métal, avec revêtement antidérapant noir



	Ø cm	↑ cm	€
33272	20	10,5	10,20
33273	20	20,0	14,50



**Buffetständer „KING“**

buffet stand  
soporte para buffet  
présentoir buffet

**kein Verrutschen, Arme und Boden sind mit Antirutschflächen ausgestattet, schwere standsichere Qualität, Fuß dient als Löffelablage**

the arms and base are equipped with non-slip surfaces, stable quality, base serves as spoon holder

revestimiento antideslizante en las puntas de los brazos y en la base, estable y alta calidad, la base sirve como reposacuchara

revêtement antidérapant sur les extrémités des 3 pieds et sur la base, robuste, stable et bonne qualité, la base sert de support pour les couverts



	Ø cm	↑ cm	€
03622	15	14	44,00
03623	15	21	48,00

## BUFFET STANDS

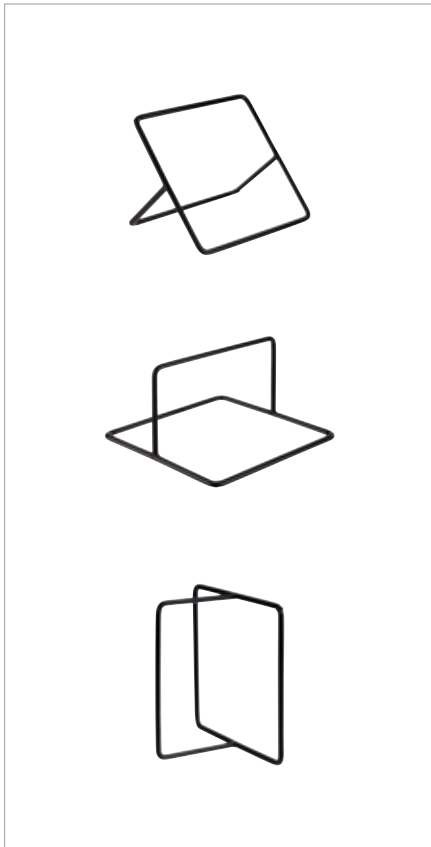

### Buffetständer „SQUARE“

buffet stand  
soporte para buffet  
présentoir buffet

**Metall, mit schwarzer Antirutschbeschichtung**

metal, with black anti-slide coating  
metal, con revestimiento antideslizante negro  
métal, avec revêtement antidérapant noir



	cm	↑ cm		€
33305	12 x 12	7		6,50



Präsentationsmöglichkeit | presentation example



### Buffetständer „PERFECTO“

buffet stand  
soporte para buffet  
présentoir buffet

**Metall, mit schwarzer Antirutschbeschichtung**

metal, with black anti-slide coating  
metal, con revestimiento antideslizante negro  
métal, avec revêtement antidérapant noir



	cm	↑ cm	fits to	€
33304	19 x 23	40,5	33202, 33303	23,60



### Buffetständer „FRIDA“

buffet stand  
soporte para buffet  
présentoir buffet

**Metall, mit schwarzer Antirutschbeschichtung**

metal, with black anti-slide coating  
metal, con revestimiento antideslizante negro  
métal, avec revêtement antidérapant noir



	∅ cm	↑ cm	fits to	€
33282	23 / 30,5	17	85230, 85231	42,00

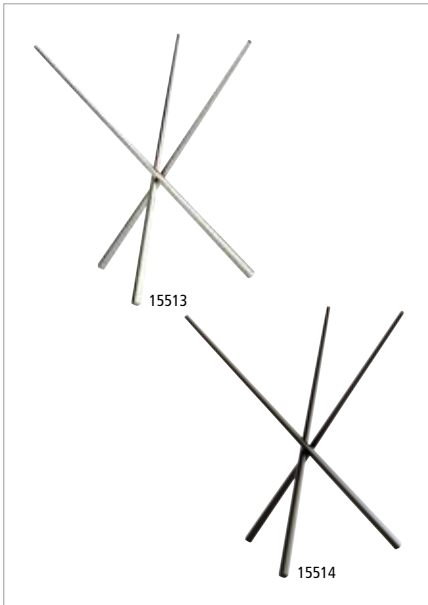

**Buffetständer „ASIA PLUS“**

buffet stand  
soporte para buffet  
présentoir buffet



	Ø cm	↑ cm	Farbe / Colour	€
15513	20,5 / 16,5	20		16,80
15514	20,5 / 16,5	20		15,60



Präsentationsmöglichkeit  
presentation example



**Buffetständer**

buffet stand  
expositor de buffet  
présentoir buffet



**Akazienholz**  
acacia wood  
madera de acacia  
bois d'acacia

	Ø cm	↑ cm	€
33255	15	10	17,00
33256	25	15	21,00



Präsentationsmöglichkeit  
presentation example



**Buffetständer „WOOD“**

buffet stand  
soporte para buffet  
présentoire buffet



**Akazienholz, liegend oder stehend, variable Nutzungsmöglichkeiten**  
acacia wood, usable by lying or standing, variable usage possibilities  
madera de acacia, se puede usar tumbado o de pie, opciones de uso variable  
bois d'acacia, possibilités d'utilisation variables

	cm	↑ cm	Farbe / Colour	€
33280	20 x 20	17,5		11,80
33281	20 x 20	17,5		11,80



liegend oder stehend, variable Nutzungsmöglichkeiten  
vertically or horizontally, variable usage possibilities

**NEW** MANGO



**Schale**

bowl  
cuenco  
bol



Mangoholz, Epoxidharz, Motiv (innen): starry sky  
mango wood, epoxy resin, design (inside): starry sky  
madera de mango, resina epoxi, diseño (interior): starry sky  
bois de manguier, résine époxy, design (intérieur): starry sky

	Ø cm	↑ cm	ltr.	€
01050	20	7,5	0,8	18,00
01053	24	7,5	1,1	21,00
01056	30	10,5	3,0	30,00
01057	37	9,0	4,0	30,00

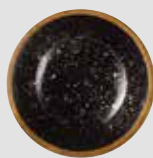

handgefertigt  
handmade



**Tablett / Teller**

tray / plate  
bandeja / plato  
plateau / assiette



Mangoholz, Epoxidharz, Motiv (innen): starry sky  
mango wood, epoxy resin, design (inside): starry sky  
madera de mango, resina epoxi, diseño (interior): starry sky  
bois de manguier, résine époxy, design (intérieur): starry sky

	Ø cm	↑ cm	€
01058	35,5	2,5	28,00



**Schale**

bowl  
cuenco  
bol



**Mangoholz, Epoxidharz, Motiv (innen): Sicily**  
mango wood, epoxy resin, design (inside): sicily  
madera de mango, resina epoxi, diseño (interior): sicily  
bois de manguier, résine époxy, design (intérieur): sicily

	Ø cm	↑ cm	ltr.	€
01052	24	7,5	1,1	21,00
01055	30	10,5	3,0	30,00



handgefertigt  
handmade

**Schale**

bowl  
cuenco  
bol



**Mangoholz, Epoxidharz, Motiv (innen): weiß+blau**  
mango wood, epoxy resin, design (inside): white+blue  
madera de mango, resina epoxi, diseño (interior): blanco+azul  
bois de manguier, résine époxy, design (intérieur): blanc+bleu

	Ø cm	↑ cm	ltr.	€
01051	24	7,5	1,1	21,00
01054	30	10,5	3,0	30,00



handgefertigt  
handmade

# ACACIA



00794 1,8 ltr.



00795 2,5 ltr.



00796 3,0 ltr.

## Schale „ACACIA“

bowl  
cuenco  
bol

aus geöltem Akazienholz  
made of oiled acacia wood  
de madera de acacia aceitada  
en bois d'acacia huilé



	Ø cm	↑ cm	ltr.	€
00794	21	8,5	1,8	35,00
00795	25	8,5	2,5	40,00
00796	27	8,5	3,0	45,00



3 Größen ineinander  
3 sizes in each other



33269

## Buffetständer „MULTI ROUND“

buffet stand  
soporte para buffet  
présentoir buffet

Metall, mit schwarzer Antirutschbeschichtung  
metal, with black anti-slide coating  
metal, con revestimiento antideslizante negro  
métal, avec revêtement antidérapant noir



	Ø cm	↑ cm	€
33269	15,5 / 18	8	10,90
33270	15,5 / 18	10	13,00
33271	15,5 / 18	18	16,70



**Schale, 3er Set „ELEMENT“**

bowl, 3 pcs.  
cuenco, set de 3  
bol, set de 3



	Ø cm	↑ cm	ltr.	pcs.	€ / set
30003	10	4,5	0,05	3	10,00



möbelschonende Unterseite  
furniture-friendly underside



**Schale „ELEMENT“**

bowl  
cuenco  
bol



	Ø cm	↑ cm	ltr.	€
30000	22	6,0 / 10,5	1,1	22,00
30001	26	7,5 / 13,0	1,7	28,00
30002	29,5	8,5 / 14,5	2,5	33,00



möbelschonende Unterseite  
furniture-friendly underside



Präsentationsmöglichkeiten  
presentation example

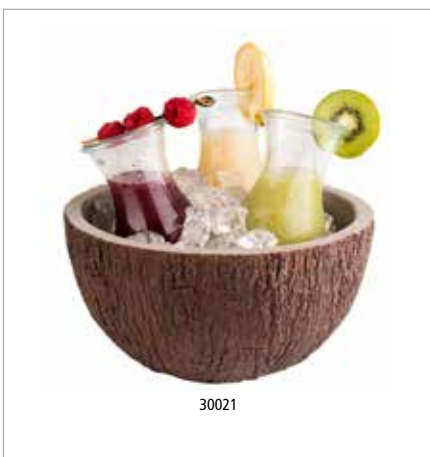

**Schale „COCONUT“**

bowl  
cuenco  
bol



	Ø cm	↑ cm	ltr.	€
30020	18	9,5	1	22,80
30021	23	12,5	2,2	30,00



möbelschonende Unterseite  
furniture-friendly underside



**Buffetständer**

buffet stand  
expositor de buffet  
présentoir buffet



Akazienholz / acacia wood / mader de acacia / bois d'acacia

	Ø cm	↑ cm	€
33255	15	10	17,00
33256	25	15	21,00



# CEREAL DISPENSERS



## Cerealienspender „FRESH & EASY“

cereal dispenser  
dispensador de cereales  
distributeur de céréales



Behälter herausnehmbar, „Feierabend-Deckel“ für das aromadichte Lagern, portionieren durch einfaches Drehen

removable canister, special lid to keep the cereals fresh, easy to use, rotate the button to get the muesli

contenedor extraíble, tapa especial para mantener los cereales frescos, fácil de usar, se gira el pomo para servir los cereales

réipient amovible, couvercle spécial pour conserver les céréales, usage facile en tournant le bouton

	cm	↑ cm	ltr.	Farbe / Colour	€
11840	22 x 17,5	52	4,5	■	90,00



## Cerealienspender Duo „FRESH & EASY“

cereal dispenser  
dispensador de cereales  
distributeur de céréales



Behälter herausnehmbar, „Feierabend-Deckel“ für das aromadichte Lagern, portionieren durch einfaches Drehen

removable canister, special lid to keep the cereals fresh, easy to use, rotate the button to get the muesli

contenedor extraíble, tapa especial para mantener los cereales frescos, fácil de usar, se gira el pomo para servir los cereales

réipient amovible, couvercle spécial pour conserver les céréales, usage facile en tournant le bouton

	cm	↑ cm	ltr.	Farbe / Colour	€
11841	22 x 35	52	2 x 4,5	■	162,00



4,5 ltr.

**Cerealienspender „FRESH & EASY“**

cereal dispenser  
dispensador de cereales  
distributeur de céréales



**Behälter herausnehmbar, „Feierabend-Deckel“ für das aromadichte Lagern, portionieren durch einfaches Drehen**

removable canister, special lid to keep the cereals fresh, easy to use, rotate the button to get the muesli  
contenedor extraíble, tapa especial para mantener los cereales frescos, fácil de usar, se gira el pomo para servir los cereales  
récipient amovible, couvercle spécial pour conserver les céréales, usage facile en tournant le bouton

	cm	↑ cm	ltr.	€
11805	22 x 17,5	52	4,5	90,00



2 x 4,5 ltr.

**Cerealienspender Duo „FRESH & EASY“**

cereal dispenser  
dispensador de cereales  
distributeur de céréales



**Behälter herausnehmbar, „Feierabend-Deckel“ für das aromadichte Lagern, portionieren durch einfaches Drehen**

removable canister, special lid to keep the cereals fresh, easy to use, rotate the button to get the muesli  
contenedor extraíble, tapa especial para mantener los cereales frescos, fácil de usar, se gira el pomo para servir los cereales  
récipient amovible, couvercle spécial pour conserver les céréales, usage facile en tournant le bouton

	cm	↑ cm	ltr.	€
11807	22 x 35	52	2 x 4,5	162,00



**Cerealienspender „ROTATION“**

cereal dispenser  
dispensador de cereales  
distributeur de céréales



**matt poliert, drehbarer massiver Ständer, Behälter herausnehmbar, inklusive Frischhaltedeckel**

matt polished, rotating food, canister removable, including airtight covers  
pulido mate, giratorio, incluye tapas herméticas  
poli mat, rotatif, inclut couvercles hermétiques

	Ø cm	↑ cm	ltr.	€
11970	38	54	3 x 4,5	320,00



**Cerealienspender „ROTATION“**

cereal dispenser  
dispensador de cereales  
distributeur de céréales



**Buchenholz versiegelt, drehbarer massiver Ständer, Behälter herausnehmbar, inklusive Frischhaltedeckel**

wood beech covered waterproof, rotating foot, canister removable, incl. airtight cover  
tapa en madera de haya resistente al agua, pie giratorio, recipiente extraíble, incluye tapa hermética  
couvercle en hêtre traitée contre l'humidité, pied rotatif, récipients démontables, inclut couvercles hermétiques

	Ø cm	↑ cm	ltr.	€
11975	38	54	3 x 4,5	324,00

## CEREAL DISPENSERS



### Cerealienspender „BRIDGE“

cereal dispenser  
dispensador de cereales  
distributeur de céréales



**Behälter herausnehmbar, „Feierabend-Deckel“ für das aromadichte Lagern, portionieren durch einfaches Drehen**

removable canister, special lid to keep the cereals fresh,  
easy to use, rotate the button to get the muesli  
contenedor extraíble, tapa especial para mantener los cereales frescos,  
fácil de usar, se gira el pomo para servir los cereales  
récipient amovible, couvercle spécial pour conserver les céréales,  
usage facile en tournant le bouton

	cm	↑ cm	ltr.	Farbe / Colour		€
13987	21 x 20	55,5	4,5		Ahorn	109,00



### Cerealienspender „BRIDGE“

cereal dispenser  
dispensador de cereales  
distributeur de céréales



**Behälter herausnehmbar, „Feierabend-Deckel“ für das aromadichte Lagern, portionieren durch einfaches Drehen**

removable canister, special lid to keep the cereals fresh,  
easy to use, rotate the button to get the muesli  
contenedor extraíble, tapa especial para mantener los cereales frescos,  
fácil de usar, se gira el pomo para servir los cereales  
récipient amovible, couvercle spécial pour conserver les céréales,  
usage facile en tournant le bouton

	cm	↑ cm	ltr.	Farbe / Colour		€
14987	21 x 20	55,5	4,5		Wenge	109,00



### Buffetständer „GOOD MORNING“

buffet stand  
expositor de buffet  
présentoir de buffet



**4-teiliges Set: 1 Holzständer inklusive 3 Gläser mit luftdichtem Klappdeckel**

4 pcs.: 1 wood stand including 3 glasses with airtight cover

set de 4: 1 soporte con 3 cuencos de cristal con cierre hermético

set de 4: 1 présentoir avec 3 bols en verre avec fermeture hermétique

	cm		Farbe / Colour		€/ set
13965	43 x 17			Ahorn	100,00
14965	43 x 17			Wenge	100,00

### Glas mit luftdichtem Klappdeckel

glass with airtight cover  
cristal, cierre hermético  
verre, fermeture hermétique

	cm	↑ cm	ltr.		€
82328	12 x 12	22	2		9,00



**Cerealien-Bar**

cereal-bar  
barra para dispensador de cereales  
bar à céréales



**5-teiliges Set: mit Ständerhöhe 4 oder 8 cm: 1 Ständer aus Acryl gefrostet und rutschfest + 2 Karaffen mit schwenkbarem Edelstahl-Deckel + 2 luftdichte Frischhaltedeckel**

5 pcs.: with stand heights 4 or 8 cm: 1 stand acryl frosted and non-slip + 2 pitchers with stainless steel flap lid + 2 airtight covers

set de 5: stands a diferentes alturas, 4 u 8 cm: 1 stand acryl + 2 jarras con tapa de solapa de acero inoxidable + 2 tapas herméticas adicionales

set de 5: supports à différentes hauteurs: 4 ou 8 cm - 1 support acrylique satiné antidérapant + 2 pichets à céréales avec couvercle à charnière inox + 2 couvercles hermétiques

	cm	↑ cm	ltr.	€
11971	26 x 17	28,5	2 x 1,5	76,00
11972	26 x 17	32,5	2 x 1,5	104,00



ideal für Stufenpräsentation  
best for staged presentations

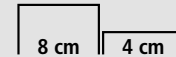

**Cerealien-Bar**

cereal-bar  
barra para dispensador de cereales  
bar à céréales



**7-teiliges Set: mit Ständerhöhe 4 oder 8 cm: 1 Ständer aus Acryl gefrostet und rutschfest + 3 Karaffen mit schwenkbarem Edelstahl-Deckel + 3 luftdichte Frischhaltedeckel**

7 pcs.: with stand heights 4 or 8 cm: 1 stand acryl frosted and non-slip + 3 pitchers with stainless steel flap lid + 3 airtight covers

set de 7: con stands a diferentes alturas, 4 u 8 cm: 1 stand acryl + 3 jarras con tapa de solapa de acero inoxidable + 3 tapas herméticas adicionales

set de 7: supports à différentes hauteurs: 4 ou 8 cm - 1 support acrylique satiné antidérapant + 3 pichets à céréales avec couvercle à charnière inox + 3 couvercles hermétiques

	cm	↑ cm	ltr.	€
11973	38 x 17	28,5	3 x 1,5	108,00
11974	38 x 17	32,5	3 x 1,5	114,00

**Cerealienkaraffe**

cereal pitcher  
jarra de cereales  
pichet à céréales



**schwenkbarer Edelstahl-Deckel, inklusive luftdichtem Frischhaltedeckel**

stainless steel flap lid, incl. 1 airtight cover

tapa giratoria de acero inoxidable con tapa hermérica para mantener los alimentos frescos

couvercle pivotant en acier inox avec couvercle hermétique pour conserver les aliments

	Ø cm	↑ cm	ltr.	€
10778	10	28	1,5	27,00

**Frischhaltedeckel / conservation lid / tapa de conservación / couvercle de conservation**

10668				3,00
-------	--	--	--	------



## BUFFET LADDER



### Buffetleiter „BIG“

buffet ladder  
dispensador en escalera  
présentoir buffet en escalier



12-teiliges Set: 4 Glasschalen Ø 23 cm 2,5 Liter, 4 klappbare Schutzdeckel mit Beschriftungsfenster, 1 Leiter, 1 Doppelring, 2 Einzelringe, einfach und individuell zusammensetzbar

12 pcs. set: 4 glass bowls Ø 23 cm 2.5 litres, 4 hinged covers with card for inscription, 1 ladder, 1 double ring, 2 single rings, easy to fix and individual to use  
set de 12: 4 cuencos de vidrio Ø 23 cm 2,5 l, 4 tapas abatibles con ventana para etiqueta, 1 soporte escalera, 1 aro doble, 2 aros sencillos, fácil de montar, posible usar individualmente  
set de 12: 4 bols en verre Ø 23 cm 2,5 l, 4 couvercles à charnière et fenêtre pour étiquette, 1 support escalier, 1 cercle double, 2 cercles simples, montage facile, utilisable individuellement

	cm	↑ cm	€
11598	39 x 31	66	210,00



### Buffetleiter „BIG“

buffet ladder  
dispensador en escalera  
présentoir buffet en escalier



11-teiliges Set: 6 Glasschalen Ø 23 cm 2,5 Liter, 1 Leiter, 2 Doppelringe, 2 Einzelringe, einfach und individuell zusammensetzbar

11 pcs. set: 6 glass bowls Ø 23 cm 2.5 litres, 1 ladder, 2 double rings, 2 single rings, easy and individual to use  
set de 11: 6 cuencos de vidrio Ø 23 cm 2,5 l, 1 soporte escalera, 2 aros dobles, 2 aros sencillos, fácil montar, se puede usar individualmente  
set de 11: 6 bols en verre Ø 23 cm 2,5 l, 1 support escalier, 2 cercles doubles, 2 cercles simples, montage facile, utilisable individuellement

	cm	↑ cm	€
11599	39 x 31	66	190,00

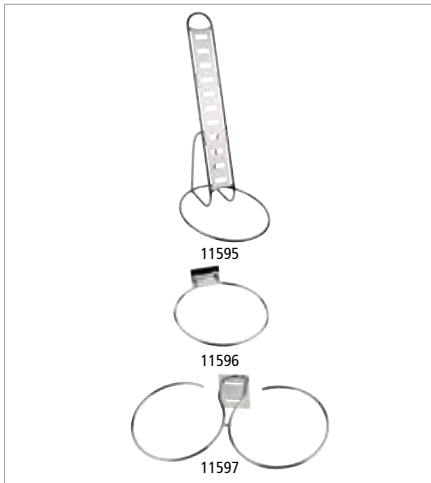

Einzelteile / spare parts / piezas de recambio / pièces détachées

Leitergestell / frame / marco solo / échelle support

	cm	↑ cm	€
11595	39 x 31	66	110,00

Einzelring / single ring / aro sencillo / cercle simple

	Ø cm	€
11596	23,5	15,00

Doppelring / double ring / aro doble / cercle double

	cm	€
11597	48 x 23,5	28,00



### Schale

bowl  
cuenco  
bol



	Ø cm	↑ cm	ltr.	€
11875	23	10,5	2,5	7,00



### Schutzdeckel mit Löffelaussparung

cover  
tapa  
couvercle



	Ø cm	€
11878	23,5	12,60





**12 tlg.**  
12 pcs.

jede Schale  
each bowl  
0,5 ltr.

**Buffeteleiter „LITTLE“**

buffet ladder  
dispensador en escalera  
présentoir buffet en escalier



**12-teiliges Set: 4 Glasschalen Ø 14 cm 0,5 Liter, 4 klappbare Schutzdeckel mit Beschriftungsfenster, 1 Leiter, 1 Doppelring, 2 Einzelringe, einfach und individuell zusammensetzbar**

12 pcs. set: 4 glass bowls Ø 14 cm 0.5 litres, 4 hinged covers with card for inscription, 1 ladder, 1 double ring, 2 single rings, easy and individual to use

set de 12: 4 cuencos de vidrio Ø 14 cm 0,5 l, 4 tapas abatibles con ventana para etiqueta, 1 soporte escalera, 1 aro doble, 2 aros sencillos, fácil montaje, se puede usar individualmente  
set de 12: 4 bols en verre Ø 14 cm 0,5 l, 4 couvercles à charnière et fenêtre pour étiquette, 1 support escalier, 1 cercle double, 2 cercles simples, montage facile, utilisable individuellement

	cm	↑ cm	€
11498	30 x 30	48	130,00



**11 tlg.**  
11 pcs.

jede Schale  
each bowl  
0,5 ltr.

**Buffeteleiter „LITTLE“**

buffet ladder  
dispensador en escalera  
présentoir buffet en escalier



**11-teiliges Set: 6 Glasschalen Ø 14 cm 0,5 Liter, 1 Leiter, 2 Doppelringe, 2 Einzelringe, einfach und individuell zusammensetzbar**

11 pcs. set: 6 glass bowls Ø 14 cm 0.5 litres, 1 ladder, 2 double rings, 2 single rings, easy and individual to use

set de 11: 6 cuencos de vidrio Ø 14 cm 0,5 l, 1 soporte escalera, 2 aros dobles, 2 aros sencillos, fácil montaje, se puede usar individualmente

set de 11: 6 bols en verre Ø 14 cm 0,5 l, 1 support escalier, 1 cercles doubles, 2 cercles simples, montage facile, utilisable individuellement

	cm	↑ cm	€
11499	30 x 30	48	110,00

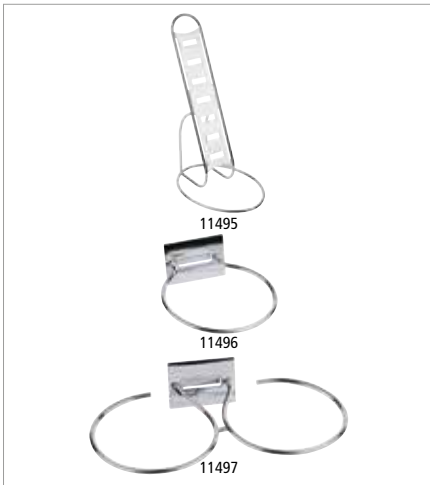

Einzelteile / spare parts / piezas de recambio / pièces détachées

**Leitergestell / frame / marco solo / échelle support**

	Ø cm	↑ cm	€
11495	30	48	40,00

**Einzelring / single ring / aro sencillo / cercle simple**

	Ø cm	€
11496	14	10,80

**Doppelring / double ring / aro sencillo / cercle double**

	cm	cm	€
11497	29,5 x 14,5	48	19,00



0,5 ltr.

**Schale**

bowl  
cuenco  
bol



	Ø cm	↑ cm	ltr.	VE / unit	€ / pc.
11865	14	6,5	0,5	6	3,00



**Schutzdeckel mit Löffelaussparung**

cover  
tapa  
couvercle



	Ø cm	€
11868	14,5	12,00

## BUFFET DISPLAY



### Buffetgestell „SUNDAY“

buffet stand  
expositor buffet  
présentoir buffet



7-teiliges Set: 3 Glasschalen Ø 23 cm (2,5 Liter), 3 klappbare Schutzdeckel, 1 Gestell

7 pcs. set: 3 glass bowls Ø 23 cm (2,5 litres), 3 hinged covers, 1 stand

set de 7: 3 cuencos de cristal Ø 23 cm (2,5 litro), 3 tapas con bisagra, 1 soporte

set de 7: 3 bols en verre Ø 23 cm (2,5 litre), 3 couvercles à charnière, 1 support

	cm	↑ cm	€
11795	61 x 24	35	136,00



11980  
Ständer ohne  
Schälchen

11981  
Ständer  
inklusive  
Schälchen

11859  
Ø 6 cm

11986  
Ständer  
inklusive  
Schälchen

83880  
Ø 6 cm

### Schälchenspender „MINI“

bowl holder  
rack dispensador para cuencos  
porte-bols



geeignet für Schalen Ø 6 cm, bestückbar mit bis zu 36 Schalen

for bowls Ø 6 cm, suitable for 36 bowls

para cuencos de Ø 6 cm, apto para 36 cuencos

pour bols de Ø 6 cm, pour 36 bols

	Ø cm	↑ cm	€
11981	14	25,5	Ständer inklusive 36 Glasschalen, Ø 6 cm frame with 36 bowls, Ø 6 cm 96,00
11986	14	25,5	Ständer inklusive 36 Melaminschalen, Ø 6 cm frame with 36 melamine bowls, Ø 6 cm 89,00

Schälchenspender „MINI“ / bowl holder / rack dispensador para cuencos / porte-bols

	Ø cm	↑ cm	€
11980	14	25,5	Ständer ohne Schalen / frame without bowls soporte sin cuencos / support sans bols 49,00



### Serviergestell „WECK“

serving stand  
expositor  
présentoir

ohne Gläser  
without glasses  
sin tarros  
sans verrines



	Ø cm	↑ cm	€
33246	22	59	12 x Ø 6 cm 94,00

passende Gläser / matching glasses / tarros adecuados / verrines appropriées

	Ø cm	↑ cm	ltr.	pcs	€ / set
82310	6	5,5	0,08	12	22,70
82312	6	7,0	0,14	12	24,80
82314	6	8,0	0,16	12	24,80

**NEW**



**Buffet Box**

buffet box  
caja buffet  
boîte à buffet

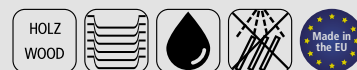

**Eichenholz, geölt, Innenmaße: 15,5 x 10 cm**

oak wood oiled, interior dimensions: 15,5 x 10 cm  
madera de roble aceitada, medidas int.: 15,5 x 10 cm  
bois de chêne huilé, dimensions int.: 15,5 x 10 cm

	cm	↑ cm	€
11728	17,5 x 15,5	12,5	22,00

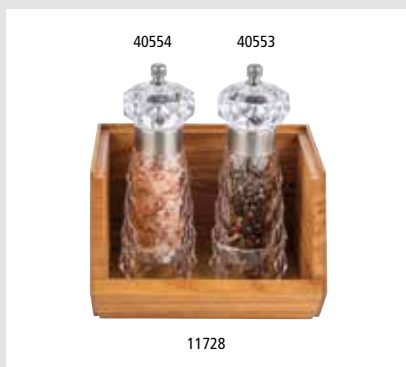

**Präsentationsmöglichkeit**  
presentation example



**stapelbar**  
stackable

**NEW**



**Buffet Box**

buffet box  
caja buffet  
boîte à buffet

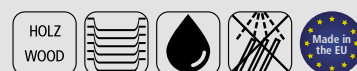

**aus geöltem Eichenholz, 2 Fächer je: 25 x 16 cm, mit 2 Griffmulden**

made of oiled oak wood, 2 compartments: each 25 x 16 cm, with 2 recessed grips  
de madera de roble aceitada, 2 compartimentos de 25 x 16 cm, con 2 asas empotradas  
en bois de chêne huilé, 2 compartiments: chacun 25 x 16cm, avec 2 poignées encastées

	cm	↑ cm	€
11729	35 x 31	12,5	52,00



**Präsentationsmöglichkeit**  
presentation example



**stapelbar**  
stackable

# BUFFET LADDER GN



## Buffetleiter „LITTLE GN 1/3“

buffet ladder  
dispensador en escalera  
présentoir buffet en escalier

4-teilig: 1 Leiter-Gestell, 3 GN 1/3 Rahmen

4 pcs.: 1 ladder, 3 single rings GN 1/3

set de 4: 1 soporte escalera, 3 aros sencillos GN 1/3

set de 4: 1 support escalier, 3 cercles simples GN 1/3



	cm	↑ cm	fits to	€
11526	31,5 x 32	48	baskets / pans GN 1/3	78,00



## Buffetleiter „LITTLE GN 1/2“

buffet ladder  
dispensador en escalera  
présentoir buffet en escalier

4-teilig: 1 Leiter-Gestell, 3 GN 1/3 Rahmen

4 pcs.: 1 ladder, 3 single rings GN 1/3

set de 4: 1 soporte escalera, 3 aros sencillos GN 1/3

set de 4: 1 support escalier, 3 cercles simples GN 1/3



	cm	↑ cm	fits to	€
11527	31,5 x 41,5	48	baskets / pans GN 1/2	98,00

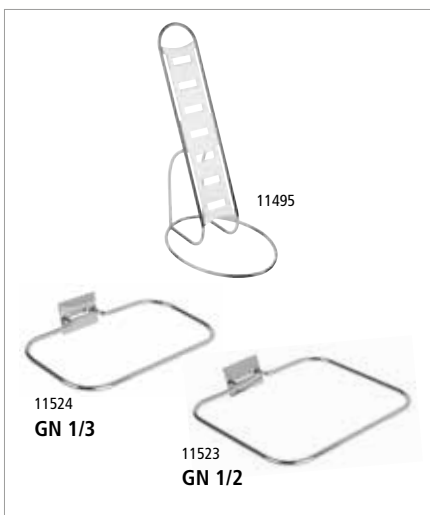

Einzelteile / spare parts / piezas sueltas / pièces détachées

Leitergestell / frame / marco de escalera / échelle support

11495	40,00
-------	-------

Einzelring GN 1/3 / single ring GN 1/3 / aro sencillo GN 1/3 / cercle simple GN 1/3

11524	14,80
-------	-------

Einzelring GN 1/2 / single ring GN 1/2 / aro sencillo GN 1/2 / cercle simple GN 1/2

11523	20,00
-------	-------



2x 84304  
**GN 1/4**

1x 83757  
**GN 1/2**

1x 83757  
**GN 1/2**

1x 83757  
**GN 1/2**

**4 tlg.**  
4 pcs.

**Buffetleiter „BIG GN 1/2“**  
buffet ladder  
dispensador en escalera  
présentoir buffet en escalier

**5-teilig: 1 Leiter-Gestell, 4 GN 1/2 Rahmen**  
5 pcs.: 1 ladder, 4 single rings GN 1/2  
set de 5: 1 soporte escalera, 4 aros sencillos GN 1/2  
set de 5: 1 support escalier, 4 cercles simples GN 1/2

**METALL VERCHROMT**

	cm	↑ cm	fits to	€
11528	31,5 x 56	66	baskets / pans GN 1/2	160,00

3x 83753  
**GN 1/3**

2x 83757  
**GN 1/2**

1x 83759  
**GN 1/1**

**4 tlg.**  
4 pcs.

**Buffetleiter „BIG GN 1/1“**  
buffet ladder  
dispensador en escalera  
présentoir buffet en escalier

**4-teilig: 1 Leiter-Gestell, 3 GN 1/1 Rahmen**  
4 pcs.: 1 ladder, 3 single rings GN 1/1  
set de 4: 1 soporte escalera, 3 aros sencillos GN 1/1  
set de 4: 1 support escalier, 3 cercles simples GN 1/1

**METALL VERCHROMT**

	cm	↑ cm	fits to	€
11529	52 x 59	66	baskets / pans GN 1/1	160,00

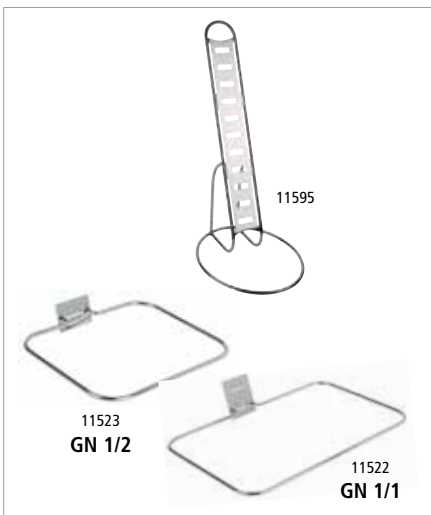

**Einzelteile / spare parts / piezas sueltas / pièces détachées**

**Leitergestell / frame / marco de escalera / échelle support**

11595	€ 110,00
-------	----------

**Einzelring GN 1/2 / single ring GN 1/2 / aro sencillo GN 1/2 / cercle simple GN 1/2**

11523	€ 20,00
-------	---------

**Einzelring GN 1/1 / single ring GN 1/1 / aro sencillo GN 1/1 / cercle simple GN 1/1**

11522	€ 31,00
-------	---------



# BEVERAGE DISPENSERS



## Getränkespender „INDUSTRIAL“

beverage dispenser  
dispensador de bebidas  
distributeur de boissons



Behälter aus Glas, Zapfhahn aus Edelstahl, Fuß und Deckel aus Metall, schwarz, Antirutschmatte aus Silikon

glass container, stainless steel tap, base and lid in black metal, silicone non-slip mat  
recipiente de vidrio, grifo de acero inoxidable, base y tapa de metal negro, tapete antideslizante de silicona

réceptien en verre, robinet en acier inox, pied et couvercle en métal noir, tapis antidérapant en silicone

	Ø cm	↑ cm	ltr.		€
10450	20	45	7	inkl. Gestell / incl. stand	100,00



Antirutschmatte aus Silikon  
silicone anti-slip mat



## Getränkespender „URBAN“

beverage dispenser  
dispensador de bebidas  
distributeur de boissons



Behälter aus Glas, Zapfhahn aus Edelstahl, Fuß und Deckel aus Metall, schwarz, Antirutschmatte aus Silikon

glass container, stainless steel tap, base and lid in black metal, silicone non-slip mat  
recipiente de vidrio, grifo de acero inoxidable, base y tapa de metal negro, tapete antideslizante de silicona

réceptien en verre, robinet en acier inox, pied et couvercle en métal noir, tapis antidérapant en silicone

	Ø cm	↑ cm	ltr.		€
10451	22	45	7	inkl. Gestell / incl. stand	100,00



Antirutschmatte aus Silikon  
silicone anti-slip mat



## Eiswasserröhre

ice cube cooling tube  
tubo enfriador para cubitos  
tube pour glaçons



	Ø cm	↑ cm	passend für Getränkenspender / fits to drink dispenser	€
10849	11	24	10400, 10403, 10450, 10451, 10855	8,80



**Getränkespender**  
beverage dispenser  
dispensador de bebidas  
distributeur de boissons



**Eichenholz (wasserfest lackiert), Zapfhahn aus Edelstahl, Untersetzer aus Melamin, Bodenplatte (Abtropfgitter) herausnehmbar**

oak wood (waterproof lacquered), Stainless steel tap, melamine coaster, removeable base plate  
madera de roble (lacado impermeable), grifo de acero inoxidable, posavasos de melamina, placa base desmontable  
bois de chêne (vernis imperméable), binet en acier inoxydable, dessous de verre en mélamine, plaque de fond amovible

	cm	↑ cm	ltr.	€
14015	21 x 21	46,5	7	240,00
14016	43,5 x 21	46,5	2 x 7	390,00



**Getränkespender „ASIA“**  
beverage dispenser  
dispensador de bebidas  
distributeur de boissons



**Behälter aus Glas, Zapfhahn aus Edelstahl, Fuß und Deckel aus Holz**

glass container, stainless steel tap, wooden stand and lid  
recipiente de vidrio, grifo de acero inoxidable, soporte y tapa de madera  
récipient en verre, robinet en acier inox, support et couvercle en bois

	Ø cm	↑ cm	ltr.	€
10403	24,5	45,5	7	inkl. Gestell / incl. stand 98,00

**Ersatz-Fuß / base / soporte de recambio / support de remplacement**

	Ø cm	↑ cm	€
10404	24,5	15	26,00

**Ersatz-Deckel / replacement lid / tapa de recambio / couvercle de rechange**

	Ø cm	↑ cm	€
10405	14,0	5	10,40



**Getränkespender „ELEMENT“**  
beverage dispenser  
dispensador de bebidas  
distributeur de boissons



**Behälter aus Glas, Zapfhahn aus Edelstahl, Fuß und Deckel aus Beton**

glass container, stainless steel tap, stand and lid made of concrete  
recipiente de vidrio, grifo de acero inoxidable, soporte y tapa de hormigón  
récipient en verre, robinet en acier inox, support et couvercle en béton

	Ø cm	↑ cm	ltr.	€
10400	22	45	7	inkl. Gestell / incl. stand 120,00

## BEVERAGE DISPENSERS



### Getränkespender

beverage dispenser  
dispensador de bebidas  
distributeur de boissons



Behälter aus Glas, Zapfhahn aus Edelstahl, Deckel aus Edelstahl

glass container, stainless steel tap, lid in stainless steel

recipiente de vidrio, grifo de acero inoxidable, tapa de acero inoxidable

réipient en verre, robinet en acier inox, couvercle en acier inox

	Ø cm	↑ cm	ltr.	€
10818 <b>NEW</b>	16	25	3,8	49,00
10855	20	30,5	7	76,00



Präsentationsmöglichkeit  
presentation example



### Unterteller

saucer  
plattillo  
sous-assiette



mit Antirutsch-Füßchen, passend zu Getränkenspender Nr. 10855

with non-slip feet, suitable for drinkdispenser art. 10855

con pies antideslizantes, para distribuidor de bebidas art. 10855

pour distributeur de boissons art. 10855

	Ø cm	↑ cm	Farbe / Colour	€
85232	19	1	■	8,40



### Tropfenschale, 2-teilig

drip tray, 2 pcs.  
aros anti-goteo, set de 2  
anneaux coupe-gouttes, set de 2



	Ø cm	↑ cm	Farbe / Colour	€
10851	9,5	1,5	■ white	8,00
10853	9,5	1,5	■ anthracite	8,00
10841 <b>NEW</b>	9,5	1,5	■ black	8,00



### Getränkespender „OLD FASHIONED“

beverage dispenser  
dispensador de bebidas  
distributeur de boissons



Behälter aus Glas, Zapfhahn aus Edelstahl, Gestell schwarz

glass container, stainless steel tap, black stand

recipiente de vidrio, grifo de acero inoxidable, soporte negro

réipient en verre, robinet en acier inox, support noir

	Ø cm	↑ cm	ltr.	€
10409	27	50,5	7	inkl. Gestell / incl. stand 85,00

Ersatz-Gestell / stand / soporte de recambio / support de remplacement

	Ø cm	↑ cm	€
10410	27	31,5	17,00

Ersatz-Glas / replacement glass / cristal de recambio / vitre de rechange

	Ø cm	↑ cm	ltr.	€
10411	19	36,5	7	49,00

Ersatz-Zapfhahn / replacement tap

	€
10718	26,00





10,5 ltr.

**Trinkglas „BEACH“**  
300 ml 10505

**Getränkespender „FRUITS“**

beverage dispenser  
dispensador de bebidas  
distributeur de boissons



**Behälter aus Glas, Zapfhahn aus Edelstahl, Gestell schwarz**

glass container, stainless steel tap, black stand  
recipiente de vidrio, grifo de acero inoxidable, soporte negro  
récipient en verre, robinet en acier inox, support noir

	Ø cm	↑ cm	ltr.		€
10415	25	58	10,5	inkl. Gestell / incl. stand	93,00

**Ersatz-Deckel / replacement glass / cristal de recambio / vitre de rechange**

	Ø cm	↑ cm		€
10418	14	12		10,00

**Ersatz-Glas inklusive Deckel, ohne Zapfhahn / replacement glass with lid without tap / cristal de recambio con tapa sin grifo / vitre de rechange avec couvercle sans robinet**

	Ø cm	↑ cm	ltr.		€
10417	25	42	10,5		40,00

**Ersatz-Zapfhahn / replacement tap / grifo de recambio / robinet de rechange**

				€
10718				26,00

**Ersatz-Gestell / stand / soporte de recambio / support de remplacement**

	Ø cm	↑ cm		€
10416	26	19		27,00



4 ltr. / 6 ltr.  
10870

**Saftdispenser „BRIDGE“**

juice dispenser  
dispensador de zumo  
distributeur à jus



**Kühlung durch 2 Kühllakkus von oben und unten**

cooling with 2 coolers from the top and base  
2 acumuladores de frío: 1 en la base y 1 en la tapa  
2 accumulateurs de froid: 1 dans le couvercle, 1 dans le socle

	cm	↑ cm	ltr.	Farbe / Colour	€
10870	31,0 x 20	42	4		239,00
10871	35,5 x 22	50	6		279,00



inklusive 3 Magnetschilder: ORANGE, APPLE, GRAPEFRUIT  
including 3 magnetic signs: ORANGE, APPLE, GRAPEFRUIT



4 ltr. / 6 ltr.  
10873

**Saftdispenser „BRIDGE“**

juice dispenser  
dispensador de zumo  
distributeur à jus



**Kühlung durch 2 Kühllakkus von oben und unten**

cooling with 2 cooling elements from the top and base  
2 acumuladores de frío: 1 en la base y 1 en la tapa  
2 accumulateurs de froid: 1 dans le couvercle et 1 dans le socle

	cm	↑ cm	ltr.	Farbe / Colour	€
10872	31,0 x 20	42	4	Wenge / wenge	239,00
10873	35,5 x 22	50	6	Wenge / wenge	279,00



inklusive 3 Magnetschilder: ORANGE, APPLE, GRAPEFRUIT  
including 3 magnetic signs: ORANGE, APPLE, GRAPEFRUIT



7,5 ltr.

300 ml

7,5 ltr.

Getränkespender „NORDIC WOOD“

beverage dispenser  
dispensador de bebidas  
distributeur de boissons



Behälter mit Edelstahlzapfhahn und Holzdeckel, stabiles Glas, inklusive weißem Holzstandfuß und Kork-Untersetzer

container with stainless steel tap and wooden cover, solid glas, including white wooden base and cork coaster

recipiente con grifo de acero inoxidable y tapa de madera, cristal sólido, pie de madera blanca y posavasos de corcho

réipient avec robinet en acier inox et covercle en bois, verre robuste, pied en bois blanc et soucoupes de liège

	cm	↑ cm	ltr.	€
10435	23 x 23	60,5	7,5	106,00

Trinkbecher „CRYSTAL“  
drinking cup / vaso / gobelet



	Ø cm	↑ cm	ltr.	VE	€ / pc.
10501	8	12,5	0,3	48	4,20

Ersatzteile Getränkspender „NORDIC WOOD“

parts beverage dispenser  
recambios dispensador de bebidas  
pièces distributeur de boissons

Ersatz-Deckel / replacement lid / tapa de recambio / couvercle de rechange

	Ø cm	↑ cm	€
10428	11,5	1,5	5,90

Ersatz-Glas inklusive Zapfhahn / replacement glass with tap / cristal de recambio con grifo / vitre de rechange avec robinet

	Ø cm	↑ cm	ltr.	€
10427	17	46	7,5	57,00

Ersatz-Untersetzer aus Kork / replacement cork coaster / posavasos de corcho de recambio / soucoupes de liège de rechange

	Ø cm	↑ cm	€
10424	16,5	1,5	6,00

Ersatz-Gestell / stand for / soporte de recambio / support de remplacement

	cm	↑ cm	Farbe / Colour	€
10426	23 x 23	14		23,00



**Getränkespender „FRESH WOOD“**

beverage dispenser  
dispensador de bebidas  
distributeur de boissons



**Behälter mit Edelstahlzapfhahn und Korkdeckel, stabiles Glas, inklusive Holzstandfuß und Kork-Untersetzer**

container with stainless steel tap and cork cover, solid glas, including wooden base and cork coaster

recipiente con grifo de acero inoxidable y tapa de corcho, cristal sólido, pie de madera y posavasos de corcho

réipient avec robinet en acier inox et covercle de liège, verre robuste, pied en bois et soucoupes de liège

	cm	↑ cm	ltr.	€
10430	23 x 23	56,5	4,5	106,00

**Trinkbecher „CRYSTAL“**  
drinking cup / vaso / gobelet



	Ø cm	↑ cm	ltr.	VE	€ / pc.
10501	8	12,5	0,3	48	4,20

**Tropfschale / drip tray / aro anti-goteo / anneau coupe-gouttes**



	Ø cm	↑ cm	Farbe / Colour	€
10851	9,5	1,5	White	8,00

**Ersatzteile Getränkspender „FRESH WOOD“**

spare parts beverage dispenser  
recambios dispensador de bebidas  
pièces distributeur de boissons

**Ersatz-Deckel / replacement lid / tapa de recambio / couvercle de rechange**

	Ø cm	↑ cm	Farbe / Colour	€
10428	11,5	1,5	Orange	5,90

**Ersatz-Glas inklusive Zapfhahn / replacement glass with tap / cristal de recambio con grifo / vitre de rechange avec robinet**

	Ø cm	↑ cm	ltr.	€
10422	15,5	42,0	4,5	55,00

**Ersatz-Untersetzer aus Kork / replacement cork coaster / posavasos de corcho de recambio / soucoupes de liège de rechange**

	Ø cm	↑ cm	€
10424	16,5	1,5	6,00

**Ersatz-Gestell / stand for / soporte de recambio / support de remplacement**

	cm	↑ cm	Farbe / Colour	€
10426	23 x 23	14	Orange	23,00



## BEVERAGE DISPENSERS



### Saftdispenser „TOWER“

juice dispenser  
dispensador de zumo  
distributeur à jus de fruit

aus Edelstahl, inklusive Crushed Ice Röhre

made of stainless steel, inclusive crushed ice tube  
de acero inoxidable con tubo para hielo picado  
en acier inox avec tube de glace pilée



	cm	↑ cm	ltr.	€
10440	35 x 23	75	5	330,00



Edelstahl Zapfhahn  
stainless steel tap



### Milchdispenser „BRIDGE“

milk dispenser  
dispensador de leche  
distributeur à lait

massives Buchenholz gebeizt, Edelstahldispenser mit 1 Kühlakku im Standfuß inklusive touchless adapter

solid beech wood, stained, stainless steel dispenser with 1 cooler in stand including touchless adapter

madera de haya maciza teñida, dispensador de acero inoxidable con 1 acumulador de frío en la base y con adaptador sin contacto para grifo

bois de hêtre massif teinté, distributeur en acier inox avec 1 accumulateur de froid dans le socle et avec adaptateur sans contact manuel



	cm	↑ cm	ltr.	Farbe / Colour	€
10837	31 x 20	39	3	■	279,00
10839	39 x 22	45	5	■	444,00



### Milchdispenser „BRIDGE“

milk dispenser  
dispensador de leche  
distributeur à lait

massives Ahornholz, Edelstahldispenser mit 1 Kühlakku im Standfuß inklusive touchless adapter

solid maple wood, stainless steel dispenser with 1 cooler in stand including touchless adapter  
madera maciza de arce, dispensador de acero inoxidable con 1 acumulador de frío en la base y con adaptador sin contacto para grifo

bois d'érable massif, distributeur en acier inox avec 1 accumulateur de froid dans le socle et avec adaptateur sans contact manuel



	cm	↑ cm	ltr.	Farbe / Colour	€
10836	31 x 20	39	3	■	279,00
10838	39 x 22	45	5	■	444,00



**Milchkanne „TOP FRESH“**

milk dispenser  
dispensador de leche  
distributeur à lait



hochglanzpoliert, 1 Kühlakku im Standfuß, „original Milchkanne mit Henkel“

mirror polished, 1 cooler in base, original milkcan  
pulido brillante, 1 acumulador de frío en la base, recipiente „lechera“  
poli brillant, 1 accumulateur de froid dans le socle, design „pot à lait“

	cm	↑ cm	ltr.	€
10830	21 x 32	39	3	320,00
10750	23 x 35	45	5	510,00

**Milchkanne ohne Zapfhahn / milkcan without tap / jarra de leche sin grifo / récipient à lait sans robinet**

	Ø cm	↑ cm	ltr.	€
10833	16	22	3	174,00
10663	22	26	5	210,00



**Milchkanne „TOP FRESH“**

milk dispenser  
dispensador de leche  
distributeur à lait



inklusive Porzellanschild zum Beschriften, 1 Kühlakku im Fuß

including porcelain sign, 1 cooler in base  
incluye cartelito en porcelana, 1 acumulador de frío en la base  
indicateur en porcelaine inclus, 1 accumulateur de froid dans le socle

	cm	↑ cm	ltr.	€
10850	31 x 21	42	4	300,00



**Milchkanne „TOP FRESH“**

milk dispenser  
dispensador de leche  
distributeur à lait



Buchenholz versiegelt, inklusive Porzellanschild zum Beschriften, 1 Kühlakku im Fuß

beech wood, waterproof, incl. porcelain sign, 1 cooler in base  
madera de haya, resistente al agua, incluye placa de porcelana, 1 acumulador de frío en la base  
socle bois hêtre traité, indicateur en porcelaine inclus, 1 accumulateur de froid dans le socle

	cm	↑ cm	ltr.	€
10840	23 x 32,0	42	4	300,00
10757	27 x 38,5	45	8	352,00

## BEVERAGE DISPENSERS



### Saftdispenser „TOP FRESH“

juice dispenser  
dispensador de zumo  
distributeur à jus de fruit



hochglanzpoliert, Kühlung durch 2 Kühllakkus von oben und unten  
mirror polished, cooling with 2 cooling elements from the top and base

pulido brillante, con 2 acumuladores de frío, 1 arriba y 1 en la base  
poli brillant, 2 accumulateurs de froid, 1 dans le couvercle, 1 dans le socle

	cm	↑ cm	ltr.	€
10800	21 x 32	43	4	248,00
10700	23 x 35	52	6	350,00



### Saftdispenser DUO „TOP FRESH“

juice dispenser  
dispensador de zumo  
distributeur à jus de fruit



hochglanzpoliert, Kühlung durch 2 Kühllakkus von oben und unten

mirror polished, cooling with 2 cooling elements from the top and base

pulido brillante, con 2 acumuladores de frío, 1 arriba y 1 en la base  
poli brillant, 2 accumulateurs de froid, 1 dans le couvercle, 1 dans le socle

	cm	↑ cm	ltr.	€
10720	42 x 32	52	2 x 6	514,00



### Saftdispenser „INOX STAR“

juice dispenser  
dispensador de zumo  
distributeur à jus de fruit



Edelstahl-Crushed Ice Röhre herausnehmbar

removable stainless steel crash ice tube  
con tubo inox refrigerante extraíble para hielo picado  
avec tube inox réfrigérant amovible pour glace pilée

	cm	↑ cm	ltr.	€
10795	36 x 26	55	8	190,00

Behälter / container / recipiente / récipient

	Ø cm	ltr.	€
10796	22	8	35,70



### Iso-Dispenser

insulated dispenser  
dispensador isotérmico  
distributeur de boisson isothermique



für heiße und kalte Getränke

for hot and cold drinks  
para bebidas frías y calientes  
pour boissons chaudes ou froides

	Ø cm	↑ cm	ltr.	€
10788	24	42	9,5	62,00

Hahn / tap / grifo / robinet

	€
10789	12,00



1) Deckel / cover / tapa / couvercle

	für ltr. / for ltr. / para ltr. / pour ltr.	€
10701	6	27,00
10801	4	23,00

2) Kühlakku / cooler / acumulador de frío / accumulateur de froid

	für ltr. / for ltr. / para ltr. / pour ltr.	€
10777	4 / 6	5,40

3) Behälter inklusive Zapfhahn / container incl. tap  
recipiente con grifo / récipient avec robinet

	für ltr. / for ltr. / para ltr. / pour ltr.	€
10703	6	178,00
10803	4	152,00

3) Behälter ohne Zapfhahn / container without tap  
recipiente sin grifo / récipient sans robinet

	für ltr. / for ltr. / para ltr. / pour ltr.	€
10704	6	134,00
10804	4	112,00

4) Non-Drip Hahn / non-drip tap / grifo anti-goteo / robinet anti-goutte

	für ltr. / for ltr. / para ltr. / pour ltr.	€
10707	6	53,00
10807	4	52,00

5) Einsatz / insert / aro inox / cercle inox

	für ltr. / for ltr. / para ltr. / pour ltr.	€
10708	6	4,40
10808	4	4,40

6) Standfuß 18/10 Edelstahl / column 18/10 stainless steel  
base inox 18/10 / socle inox 18/10

	für ltr. / for ltr. / para ltr. / pour ltr.	€
10709	6	74,00
10809	4	56,00

7) Tropfgitter 18/10 Edelstahl / drip lattice 18/10 stainless steel  
rejilla recoge gotas 18/10 / grille ramasse-gouttes 18/10

	für ltr. / for ltr. / para ltr. / pour ltr.	€
10712	6	26,00
10713	DUO	46,00
10812	4	23,00

8) Bodenplatte 18/10 Edelstahl / footing 18/10 stainless steel  
base de 18/10 acero / socle inox 18/10

	für ltr. / for ltr. / para ltr. / pour ltr.	€
10710	6	51,00
10711	DUO / 6 + 6	108,00
10814	4	35,00

1 x Dichtung, 2 x Dichtungsring (transparent), 1 x Dichtungsring (s / w)  
1 x seal, 2 x sealing ring (transparent), 1 x sealing ring (b / w)

Zubehör / Reinigungsset - für die regelmäßige Reinigung

		€
10714	für Zapfhahn 10707	4,20
10715	für Zapfhahn 10807	4,20
10716	für Zapfhahn 10907	5,60
10717	für Zapfhahn 10867	5,60



# BEVERAGE DISPENSERS

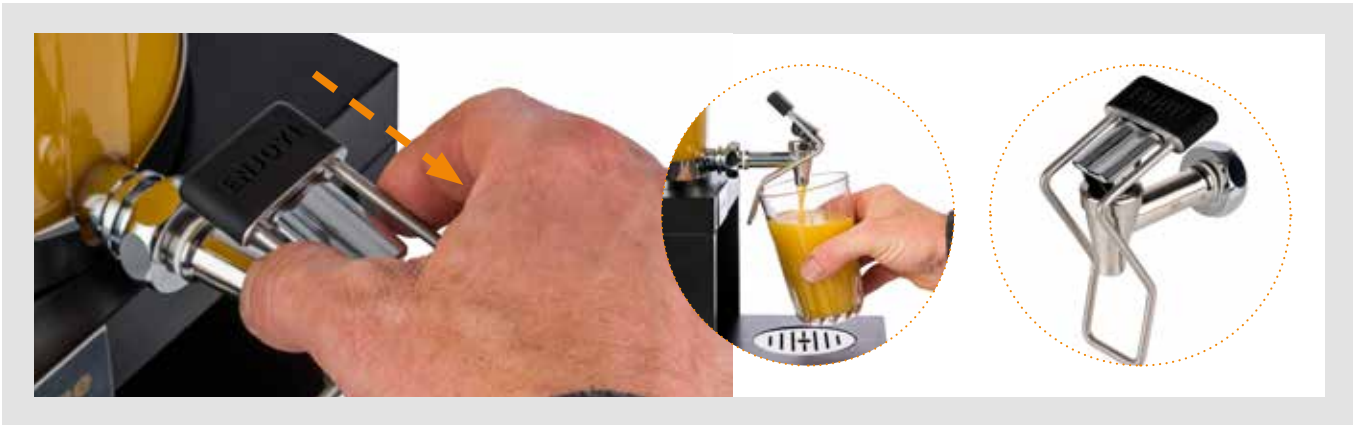

Der Adapter passt auf alle Dispenser der Serien TOP FRESH, BRIDGE und SUNDAY und kann ganz einfach installiert werden.

The adapter fits all dispensers of the series TOP FRESH, BRIDGE and SUNDAY and can be installed very easily.

El adaptador se adapta a todos los dispensadores de las series TOP FRESH, BRIDGE y SUNDAY y puede ser instalado fácilmente.

L'adaptateur s'adapte à tous les distributeurs des séries TOP FRESH, BRIDGE et SUNDAY et peut être installé très facilement.

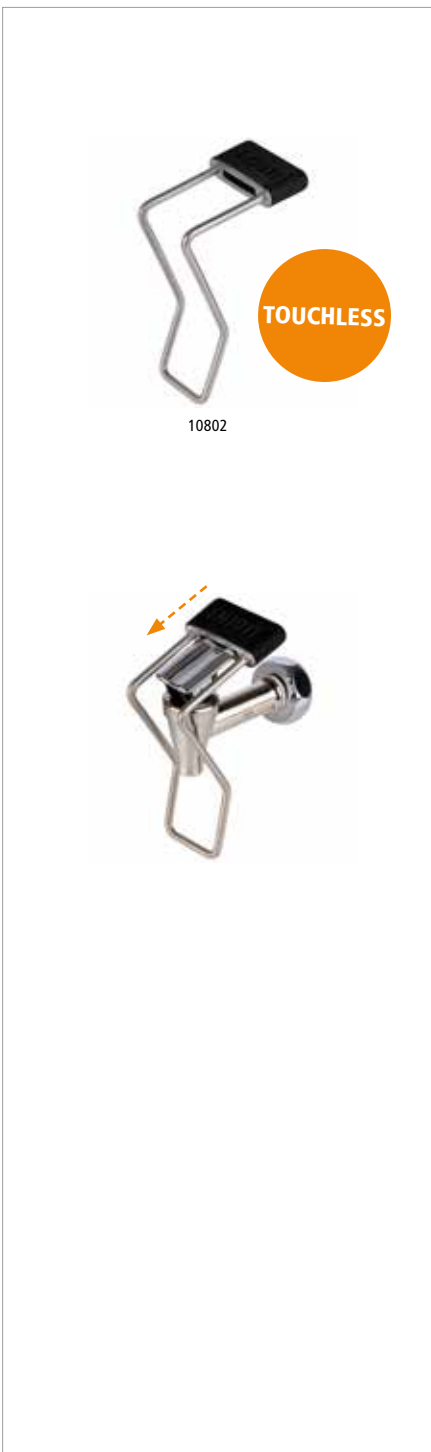

## Adapter „TOP FRESH“

adapter  
adaptador  
adaptateur

EDELSTAHL  
STAINLESS  
INOX  
18/8

SILIKON  
SILICON



handkontaktloser Adapter, einfach zu installieren

adapter touchless for tap, easy to install

adaptador sin contacto para grifo

adaptateur sans contact manuel, facile à installer

	cm	↑ cm	€
10802	12 x 4,5	5,5	10,00



Einfach den Adapter an der dafür vorgesehenen Öffnung auf den Hebel des Zapfhahns stecken.

Simply plug the adapter onto the lever of the tap at the opening provided.



Anschließend den Adapter nach unten festziehen. Durch das Nachvorne-Drücken des unteren Edelstahlbügels mit Hilfe des Glases, wird der Hebel des Zapfhahns betätigt und das Getränk fließt völlig handkontaktlos in das Glas.

Then tighten the adapter downwards. By pushing the lower stainless steel bracket forward with the help of the glass, the lever of the tap is activated and the drink flows into the glass completely without hand contact.

passend für / suitable for:



10700  
6 ltr.

Saftdispenser „TOP FRESH“  
Katalog Seite 118  
juice dispenser,  
catalogue page 118



10830  
3 ltr.

Milchkanne „TOP FRESH“  
Katalog Seite 117  
milk dispenser,  
catalogue page 117



NEW

# DRINKING BOTTLES



NEW



66907 0,55 ltr



66908 0,75 ltr



66909 1 ltr

**Trinkflasche**  
drinking bottle  
botella para beber  
gourde

Glas mit Schraubverschluss aus 18/8 Edelstahl  
screw cap made of 18/8 stainless steel  
tapón de rosca de 18/8 acero inoxidable  
bouchon à vis en 18/8 acier inox

GLAS  
GLASS

EDELSTAHL  
STAINLESS  
INOX  
18/8

PP  
POLYPROPYLEN

SILIKON  
SILICON



	Ø cm	↑ cm	ltr.	€
66907	6,5	23,5	0,55	4,60
66908	7	26,5	0,75	5,60
66909	7,5	28,5	1	6,60



66907

66908

66909



...immer dabei



mit Schraubverschluss  
with screw cap

66907

0,55 ltr

66908

0,75 ltr

66909

1 ltr

# CARAFES



## Glaskaraffe

glass carafe  
jarra de vidrio  
pichet en verre

**der Deckel öffnet sich beim Ausgießen automatisch**  
cover opens automatically while pouring  
la tapa se abre automáticamente durante el vertido  
le couvercle s'ouvre seul pendant le service



	Ø cm	↑ cm	ltr.	€
10766	9,5	29	1	24,00



## Saft- / Wasserkanne

juice / water pitcher  
jarra de zumo / agua  
pichet à eau ou jus de fruit

**Deckel aus Edelstahl matt poliert, Ausgießer für tropffreies Ausgießen**  
stainless steel cover, matt polished, spout for drip-free pouring  
tapa de acero inoxidable pulido mate, pico para verter sin gotear  
couvercle en acier inox poli mat, bec verseur pour verser sans goutter



	Ø cm	↑ cm	ltr.	€
10764	9,5	27	1,5	25,60



## Saft- / Wasserkanne

juice / water pitcher  
jarra de zumo / agua  
pichet à eau ou jus de fruit

**Deckel aus Edelstahl matt poliert, mit integriertem Auffangsieb für Kerne oder Eis**  
lid made of matt polished stainless steel, with integrated strainer for cores or ice  
tapa de acero inoxidable pulido mate, con filtro integrado para los huesos o el hielo  
couvercle en acier inox poli mat, avec filtre intégré pour les pépins ou la glace



	Ø cm	↑ cm	ltr.	€
10792	10	26	1,5	20,00



**Deckel mit Doppelfunktion**  
lid with double function



**Podest für Glaskaraffe**

podest for glass carafe  
pedestal para jarra de vidrio  
podium pour pichet en verre

**Eichenholz (wasserfest lackiert)**  
oak wood (waterproof lacquered)  
madera de roble (lacado impermeable)  
bois de chêne (vernis imperméable)



	cm	↑ cm	fits to	€
14019	15 x 15	12	10738, 10739, 10741, 10742, 10721, 10722	14,00

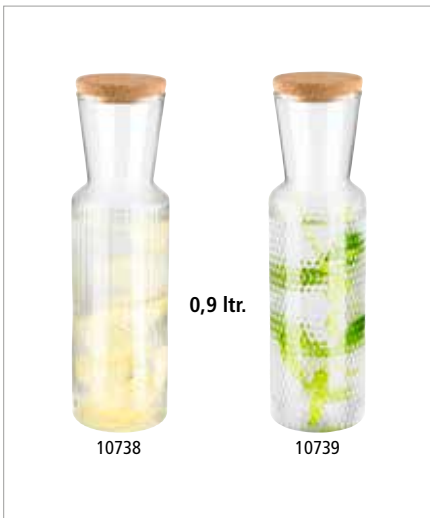

**Glaskaraffe**

glass carafe  
jarra de vidrio  
carafe en verre



	Ø cm	↑ cm	ltr.	Design	€
10738	8	27	0,9	LINES	22,00
10739	8	27	0,9	DOTS	22,00



**Detailansicht**  
detail view „LINES“



**Detailansicht**  
detail view „DOTS“



**inklusive Korkdeckel**  
incl. cork cover



**Glaskaraffe**

glass carafe  
jarra de vidrio  
carafe en verre



	Ø cm	↑ cm	ltr.	Design	€
10741	8	28	0,8	COMB	20,00
10742	8	28	0,8	DIAMOND	20,00



**Detailansicht**  
detail view „COMB“



**Detailansicht**  
detail view „DIAMOND“



**inklusive Holzkorken mit Silikondichtung**  
including wooden cork with silicone gasket



**Glaskaraffe**

glass carafe  
jarra de vidrio  
carafe en verre

**Deckel aus Edelstahl matt poliert, Ausgießer für tropffreies Ausgießen**  
lid made of matt polished stainless steel, spout for drip-free pouring  
tapa de acero inoxidable pulido mate, pico para verter sin gotear  
couverture en acier inox poli mat, bec verseur pour verser sans goutter



	Ø cm	↑ cm	ltr.	€
10721	8	25	1,0	16,00
10722	8	32	1,3	18,20

## CARAFES



1,8 ltr.

### Saft- / Wasserkanne

juice / water pitcher  
jarra de zumo / agua  
pichet à eau ou jus de fruit



#### Deckel mit Auffangsieb für Kerne oder Eis

lid with integrated strainer for cores or ice  
tapa con filtro integrado para los huesos o el hielo  
couverture avec filtre intégré pour les pépins ou la glace

	Ø cm	↑ cm	ltr.	€
10691	12	26	1,8	13,90



2 tlg.  
2 pcs.

1,0 ltr.

300 ml

### Glaskaraffe „OLD FASHIONED“, 2 teilig

glass carafe, 2 pcs.  
jarra de vidrio, set de 2  
carafe en verre, set de 2



1 Flasche 1,0 ltr., 1 Glas 0,3 ltr.

1 bottle 1,0 ltr., 1 glass 0,3 ltr.

1 botella 1,0 ltr., 1 vaso 0,3 ltr.

1 bouteille 1,0 ltr., 1 verre 0,3 ltr.

	Ø cm	↑ cm	ltr.	€
10690	9,5	31	1,0	15,90

Ersatzglas / replacement glass / vaso de recambio / verre de remplacement

	Ø cm	↑ cm	ltr.	VE / unit	€ / pc.
10520	8	12,5	0,3	6	2,10



11705

11706

### Buffetbrett

buffet board  
tabla de buffet  
planche de buffet



für Karaffen, mit 3 Einsätzen Ø 11 cm aus Kunstleder, aus geöltem Eichenholz

for carafes, with 3 leatherette inserts Ø 11 cm, made of oiled oak wood

para jarras, con 3 inserciones de imitación de cuero Ø 11 cm, de madera de roble aceitada

pour pichets, avec 3 inserts en similicuir Ø 11 cm, en bois de chêne huilé

	cm	↑ cm	Farbe / Colour	€
11705	47 x 19	2	natural oak	82,00
11706	47 x 19	2	dark oak	82,00

6 Einsätze aus Kunstleder / 6 leatherette inserts / 6 inserciones de imitación de cuero / 6 inserts en similicuir

	Ø cm	Farbe / Colour	pcs.	€ / set
35716	11	anthracite	6	17,00



Kunstledereinsatz herausnehmbar  
removable leatherette insert



3,0 ltr.

### Saft- / Wasserkanne

juice / water pitcher  
jarra de zumo / agua  
pichet à eau ou jus de fruit



mit Eiswasserröhre

with water ice tube

con tubo para hielo

avec tube à glaçons plongeant pour réfrigérer



	Ø cm	↑ cm	ltr.	€
10770	18	29	3	29,60

**NEW**



10692 1 ltr.

**Soft- / Wasserkanne**

juice / water pitcher  
jarra de zumo / agua  
pichet à jus de fruit / eau

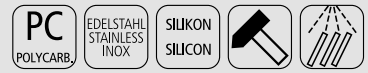

**Deckel aus Edelstahl mit Silikondichtung, mit integriertem Auffangsieb für Kerne oder Eis**

stainless steel lid with silicone seal, with integrated strainer for cores or ice

tapa de acero inoxidable con junta de silicona, con filtro integrado para los huesos o el hielo

couvercle en acier inox avec joint en silicone, avec filtre intégré pour les pépins ou la glace

	Ø cm	↑ cm	ltr.	€
10692	10	19	1	18,00
10693	11,5	24	1,8	21,00



**Deckel mit Doppelfunktion**  
lid with double function



2,8 ltr.

**Soft- / Wasserkanne**

juice / water pitcher  
jarra de zumo / agua  
pichet à eau ou jus de fruit



**mit Eiswasserröhre / with water ice tube / con tubo para hielo / avec tube d'eau glacée**

	cm	↑ cm	ltr.	€
10769	19 x 13	27	2,8	25,00



10775 2,0 ltr.      10776 2,5 ltr.

**Soft- / Wasserkanne**

juice / water pitcher  
jarra de zumo / agua  
pichet à eau ou jus de fruit



	Ø cm	↑ cm	ltr.	€
10775	12	26	2	24,00
10776	14	29	2,5	22,00



1,6 ltr.

**Karaffe**

bottle  
botella  
bouteille



**Schraubdeckel mit aromadichtem Verschluss**

screwed lid, aroma-tight

tapón de rosca, impide la fuga de aromas

bouchon à visser, ne laisse pas passer les arômes

	Ø cm	↑ cm	ltr.	Farbe / Colour	€
10771	11	30	1,6		16,00



10748 1 ltr.      10749 1 ltr.

Flaschenverschluss  
bottle top

**Flasche „STRIPES“**

bottle  
botella  
bouteille



	Ø cm	↑ cm	ltr.	Farbe / colour	€
10748	9	28,5	1		12,50
10749	9	28,5	1		12,50

## BEVERAGE BOWLS



Pitcher  
pitcher  
jarra  
pichet



	Ø cm	↑ cm	ltr.	€
93090	12,5	17,5	1,0	9,00
93091	13,5	20,0	1,5	10,00

passende Deckel / fitting lids / tapa adecuadas / couvercles appropriées

	cm	↑ cm	fits to	€
93092	13,0	1,5	93090	1,90
93093	14,0	1,5	93091	1,90



Deckel mit Klappe  
lid with flap



einfaches Ausgießen  
easy pouring out



stapelbar  
stackable



Pitcher  
pitcher  
jarra  
pichet



	Ø cm	↑ cm	ltr.	€
93105	13	21	1,5	10,40



Kühlbox „FROSTY“  
bottle cooler  
enfriador de botellas  
rafraichisseur de bouteilles



mit herausnehmbarem Einsatz für 4 Flaschen  
with removable insert for 4 bottles  
con inserto extraíble para 4 botellas  
avec insert amovible pour 4 bouteilles



Abb. ohne Einsatz  
illustration without insert

	cm	↑ cm	ltr.	hole ø cm	€
93230	27 x 27	15	7,5	11	37,00



Flaschenkühler „BIG BOWL“  
bottle cooler  
enfriador de botella  
rafraichisseur de bouteille



gehämmerte Oberfläche, innen mattiert, herausnehmbarer Tropfeinsatz  
hammered surface, matted inside, removable drip tray  
superficie martillada, interior mate, bandeja de goteo extraíble  
surface martelée, intérieur mat, bac de récupération amovible

	Ø cm	↑ cm	ltr.	€
36130	37	23	8	240,00





36111 7 ltr.

36112 7 ltr.

Wein- / Sektkühler „XL“

wine / champagne bowl  
cubitera para vino y cava  
seau à vin ou champagne

gehämmerte Oberfläche, mit 2 seitlichen Eingriffen

hammered surface, with 2 handles on the side

superficie martillada, con 2 asas

surface martelée, avec 2 poignées



	cm	↑ cm	ltr.	Farbe / Colour	€
36111	30 x 23,5	23	7	copper-look	65,00
36112	30 x 23,5	23	7	gunmetal-look	65,00



36109 3,9 ltr.

36108 3,9 ltr.

Wein- / Sektkühler „LARGE“

wine / champagne bowl  
cubitera para vino y cava  
seau à vin ou champagne

gehämmerte Oberfläche, mit 2 seitlichen Eingriffen, für 1-2 Flaschen

hammered surface, with 2 handles on the side, for 1-2 bottles

superficie martillada, con 2 asas, para 1-2 botellas

surface martelée, avec 2 poignées, pour 1-2 bouteilles



	cm	↑ cm	ltr.	Farbe / Colour	€
36108	25,5 x 19	20	3,9	copper-look	35,00
36109	25,5 x 19	20	3,9	gunmetal-look	35,00



36106 2,1 ltr.

36107 2,1 ltr.

Wein- / Sektkühler „SMALL“

wine / champagne bowl  
cubitera para vino y cava  
seau à vin ou champagne

gehämmerte Oberfläche, für 1 Flasche

hammered surface, for 1 bottle

superficie martillada, para 1 botella

surface martelée, pour 1 bouteille



	cm	↑ cm	ltr.	Farbe / Colour	€
36106	20,5 x 14	17	2,1	copper-look	26,00
36107	20,5 x 14	17	2,1	gunmetal-look	26,00



36100 11 ltr.

36095 11 ltr.

Getränkewanne „TIN“

beverage tub  
barreño botellines  
bassine à glace

Metall verzinkt, mit Kunststoffeinsatz

galvanised metal, with plastic insert

metal galvanizado, con inserto de plástico

métal galvanisé, avec insert en plastique



	cm	↑ cm	ltr.	Farbe / Colour	€
36100	40 x 28	22	11	copper-look	36,00
36101	40 x 28	22	11	black-metal-look	31,00
36095	40 x 28	22	11	metal-look	30,00
36096	50 x 23	23	18	metal-look	36,00



mit Kunststoffeinsatz  
with plastic insert  
con inserto de plástico  
avec insert en plastique



71490

Kreidestift zum  
Beschriften | chalk  
marker for writing  
S. 346

# CONFERENCE



## Flaschenkühler „CONFERENCE“

conference bottle cooler  
enfriador múltiple  
rafraîchisseur



inklusive Kühllakku, Flaschenöffner, Kronkorkenschale,  
mit 6 Öffnungen Ø 6,7 cm für 0,25 - 0,5 Liter-Flaschen

incl. bottle cooler, bottle opener, small cap bowl,  
with 6 holes Ø 6,7 cm for 0,25 to 0,5 liter bottles

con acumulador de frío, abridor, recuperador de chapas,  
6 plazas Ø 6,7 cm, para botellas de 0,25 a 0,5 ltr.

avec accumulateur de froid, décapsuleur, bol récupérateur  
de capsules, 6 places Ø 6,7 cm, pour bouteilles de 0,25 à 0,5 litres

	Ø cm	↑ cm	Farbe / Colour	€
00620	23	15	■	54,00
00621	23	15	■	54,00



## Kühllakku

cooler  
acumulador de frío  
accumulateur de froid



	Ø cm	→ cm	Farbe / Colour	€
00615	7,5	11,5	■	10,50



## Flaschenöffner

bottle opener  
abridor  
décapsuleur



	Ø cm	→ cm	€
00617	1	13,5	6,10



## Kronkorkenschale

cap bowl  
cuenco para chapas  
bol récupérateur de capsules



	Ø cm	↑ cm	Farbe / Colour	€
00618	6,5	3	■	2,50
00619	6,5	3	■	2,50





10,5 ltr.

**Kaffeedispenser „HAPPY HOUR“**

coffee dispenser  
dispensador de café  
distributeur de café



hochglanzpoliert, für warme Getränke, stabil und standfest, inklusive 1 Brennpastenbehälter  
mirror polished, for warm drinks, solid and stable, including 1 burner holder  
pulido brillante, para bebidas calientes, sólido y estable, incluye un calentador  
poli brillant, pour boissons chaudes, robuste et stable, avec 1 brûleur

	cm	↑ cm	ltr.	€
11672	31 x 33,5	54,5	10,5	210,00

**Hahn / tap / grifo / robinet**

	€
11671	27,00

**Elektro-Heizelement / heating unit / resistencia / résistance**

	cm	↑ cm	€
12287	21 x 20	6	99,00



**Pump-Isolierkanne „PREMIUM“**

air pot  
jarra termo  
bouteille isotherme



matt poliert, doppelwandig, Tragegriff, Drehverschluss, Pumpmechanismus, Füllstandsanzeigefür heiße und kalte Getränke, inklusive 4 Beschriftungsclips, für 24 Tassen

matt polished, double-walled, carrying handle, screw cap, pump mechanism, fill level indicator, for hot and cold beverages, including 4 beverage signs, for 24 cups

pulido mate, doble pared, asa de transporte, tapón de rosca, mecanismo de bombeo, indicador de nivel para bebidas calientes y frías, con 4 clips para marcar, para 24 tazas

poli mat, double paroi, poignée de transport, fermeture rotative, mécanisme de pompage, indicateur de niveau pour boissons chaudes et froides, avec 4 clips d'inscriptions, pour 24 tasses

	Ø cm	↑ cm	ltr.	Anzahl der Tassen	€
10916	15	37	3	24	70,00

**Tropfenfänger für Pump-Isolierkanne / drip tray for air pot / recogegotas para jarra termo / ramasse-gouttes pour bouteilles isotherme**

	cm	↑ cm	€
10917	24 x 18,5	4	11,40



**Pump-Isolierkanne „BUDGET“**

air pot  
jarra termo  
bouteille isotherme



Edelstahl, Polypropylen, matt poliert, doppelwandig, Tragegriff, Dreh-Pumpknopf, für heiße und kalte Getränke, für 17 Tassen

stainless steel, polypropylene, matt polished, double-walled, carrying handle, push-button, for hot and cold beverages, for 17 cups

acero inoxidable, polipropileno, pulido mate, doble pared, asa de transporte, botón giratorio de la bomba, para bebidas calientes y frías, para 17 tazas

acier inox, polypropylène, poli mat, double paroi, poignée de transport, bouton de pompage rotatif, pour boissons chaudes et froides, pour 17 tasses

	Ø cm	↑ cm	ltr.	Anzahl der Tassen	€
10915	13,5	32,5	2,2	17	28,00

# VACUUM JUGS



## Isolierkanne „ADVANCED“

vacuum jug  
jarra termo  
bouteille isotherme



doppelwandig, spülmaschinenfest, Einhandautomatik, aufgeklappt passt die Kanne unter die gängigen Kaffeeautomaten, für heiße und kalte Getränke

double-walled, dishwasher-safe, easy pouring system, with flipped-back lid, the air pot fits under a wide range of coffee makers, for hot and cold beverages

doble pared, resistente al lavavajillas, se maneja con 1 mano, con la tapa abierta la jarra se puede usar con casi todas las cafeteras corrientes, para bebidas frías y calientes

double paroi, résistante au lave-vaisselle, usage à 1 main, avec la couvercle ouverte a

bouteille se peut user avec toutes les machines à café courantes, pour boissons chaudes ou froides

	Ø cm	↑ cm	ltr.	Anzahl der Tassen	€
10921	10,5	13,0	0,3	2,5	45,00
10922	10,5	18,0	0,6	5,0	52,00
10923	13,0	19,5	1,0	8,0	58,00
10924	13,0	23,5	1,5	12,0	65,00



Deckel klappbar  
lid foldable



## Isolierkanne „VEGAN ADVANCED“

vacuum jug  
jarra termo  
bouteille isotherme



doppelwandig, spülmaschinenfest, Einhandautomatik, aufgeklappt passt die Kanne unter die gängigen Kaffeeautomaten, für heiße und kalte Getränke, mit Gravur „VEGAN“

double-walled, dishwasher-safe, easy pouring system, with flipped-back lid, the air pot fits under a wide range of coffee makers, for hot and cold beverages, with engraving „VEGAN“

doble pared, resistente al lavavajillas, se maneja con 1 mano, con la tapa abierta la jarra se puede usar con casi todas las cafeteras corrientes, para bebidas frías y calientes, con grabado „VEGAN“

double paroi, résistante au lave-vaisselle, usage à 1 main, avec la couvercle ouverte a bouteille se peut user avec toutes les machines à café courantes, pour boissons chaudes ou froides, avec gravure „VEGAN“

	Ø cm	↑ cm	ltr.	Anzahl der Tassen	€
10353	10,5	18,0	0,6	5,0	53,00
10354	13,0	19,5	1,0	8,0	59,00



**Isolierkanne „CLASSIC“**

vacuum jug  
jarra termo  
bouteille isotherme



**doppelwandig, Einhandautomatik, Drehverschluss, für heiße und kalte Getränke**

double-walled, easy push-button pouring system, screw cap, for hot and cold drinks

doble pared, se maneja con 1 mano, con tapa a rosca, para bebidas frías y calientes

double paroi, usage à 1 main, couvercle à visser, pour boissons chaudes ou froides

	Ø cm	↑ cm	ltr.	Anzahl der Tassen	€
10910	14	19	1,0	8	16,90
10911	14	22	1,5	12	18,40
10912	14	25	2,0	16	21,20



**Isolierkanne „VEGAN CLASSIC“**

vacuum jug  
jarra termo  
bouteille isotherme



**doppelwandig, Einhandautomatik, Drehverschluss, für heiße und kalte Getränke**

double-walled, easy push-button pouring system, screw cap, for hot and cold drinks

doble pared, se maneja con 1 mano, con tapa a rosca, para bebidas frías y calientes

double paroi, usage à 1 main, couvercle à visser, pour boissons chaudes ou froides

	Ø cm	↑ cm	ltr.	€
10352	14	19	1,0	21,00



**Isolierkanne „ECONOMY“**

vacuum jug  
jarra termo  
bouteille isotherme



**robuste Umhüllung mit Polypropylen-Kunststoff, Stabilglaseinsatz, Drehverschluss mit Drucktasten-Bedienung für heiße und kalte Getränke, 8 Tassen**

double-walled with glass liner, screw cap with easy push-button pouring system, for hot and cold beverages, 8 cups

exterior de plástico polipropileno, interior aislante de vidrio, con tapa a rosca con cierre dosificador para bebidas frías y calientes, 8 tazas

extérieur en plastique polypropylène, intérieur avec plaque de verre, couvercle à visser, pour boissons chaudes ou froides, 8 tasses

	Ø cm	↑ cm	ltr.	Farbe / Colour	€
10913	16	20	1	White	17,40
10914	16	20	1	Black	17,40

# TEAPOTS



## Teekanne „ASIA“

teapot  
tetera  
théière



aus Gusseisen, innen emailliert, abnehmbarer Deckel, mit Teesieb aus Edelstahl

made of cast iron, enamelled inside, removable lid, with tea strainer made of stainless steel  
hierro fundido, interior esmaltado, tapa extraíble, con colador de té de acero inoxidable  
en fonte, émaillé à l'intérieur, couvercle amovible, avec une passoire à thé en acier inox

	cm	↑ cm	ltr.	Farbe / Colour	€
10995	17 x 14	17	0,8		26,00
10996	17 x 14	17	0,8		26,00



## Teekanne „ASIA“

teapot  
tetera  
théière



aus Gusseisen, innen emailliert, abnehmbarer Deckel, mit Teesieb aus Edelstahl

made of cast iron, enamelled inside, removable lid, with tea strainer made of stainless steel  
hierro fundido, interior esmaltado, tapa extraíble, con colador de té de acero inoxidable  
en fonte, émaillé à l'intérieur, couvercle amovible, avec une passoire à thé en acier inox

	cm	↑ cm	ltr.	Farbe / Colour	€
10991	19,5 x 18	15	0,8		26,00
10992	19,5 x 18	15	0,8		26,00



## Teekanne „ASIA“

teapot  
tetera  
théière



aus Gusseisen, innen emailliert, mit abnehmbarem Deckel, ohne Teesieb aus Edelstahl  
made of cast iron, enamelled inside, with removable lid, without tea strainer made of stainless steel

hierro fundido, interior esmaltado, con tapa extraíble, sin colador de té de acero inoxidable  
en fonte, émaillé à l'intérieur, avec couvercle amovible, sans une passoire à thé en acier inox

	cm	↑ cm	ltr.	Farbe / Colour	€
10990	12,5 x 11	12,5	0,3		21,00



10994



10993

**Stövchen „ASIA“**

teapot warmer  
calentador de tetera  
chauffe-théière



**1-flammiges Stövchen aus Gusseisen mit abnehmbarem Deckel (Lieferung ohne Teelicht).**

1-flame cast iron warmer with removable lid (delivery without tealight).

calentador de tetera de hierro fundido con 1 quemador con tapa extraíble (se entrega sin vela).

chauffe-théière en fonte à 1 brûleur avec couvercle amovible (livraison sans bougie).

	∅ cm	↑ cm	Farbe / Colour	€
10994	13	7,5	■	16,40

**Untersetzer aus Gusseisen mit Antirutschfüßchen / cast iron coaster with non-slip feet**

	∅ cm	↑ cm	Farbe / Colour	€
10993	13,5	1,5	■	5,50



11575

**Teebox**

tea-box  
caja para té  
boîte à thés et infusions



**Box aus Rubberwood mit Sichtfenster, mit Aufschrift „Tee“, 4 Kammern können mit je 30 kuvertierten Teebeuteln bestückt werden**

rubber wood box with clear transparent window, with inscription „Tee“, 4 chambers for approx. 30 tea bags each

caja de madera de goma clara con ventana transparente, con inscripción „Tee“, 4 compartimentos, y cada uno para aproximadamente 30 bolsitas de té

en bois d'hévéa clair avec fenêtre, avec inscription „Tee“, 4 compartiments, pour environ 30 sachets chacun

	cm	↑ cm	Farbe / Colour	€
11575	33,5 x 20	9	■	21,00
11574	33,5 x 20	9	■	21,00

	cm	↑ cm	Farbe / Colour	€
11576	33,5 x 20	9	■	21,00

ohne Aufschrift / without inscription  
sin inscripción / sans inscription



11776

**Teebox**

tea-box  
caja para té  
boîte à thés et infusions



**Box aus Rubberwood mit Sichtfenster, mit Aufschrift „Tee“, 12 Kammern können mit je 12 kuvertierten Teebeuteln bestückt werden**

rubber wood box with clear transparent window, with inscription „Tee“, 12 chambers for approx. 12 tea bags each

caja de madera de goma clara con ventana transparente, con inscripción „Tee“, 12 compartimentos, y cada uno para aproximadamente 12 bolsitas de té

en bois d'hévéa clair avec fenêtre, avec inscription „Tee“, 12 compartiments, pour environ 12 sachets chacun

	cm	↑ cm	Farbe / Colour	€
11775	31 x 28	9	■	28,00
11776	31 x 28	9	■	28,00

**Teebox / Multibox**

tea caddy  
caja para té  
boîte à thés et infusions



**3 Fächer für kuvertierte Teebeutel, 1 Fach für Zucker, Kekse, etc., Deckel aufklappbar**

3 compartments for tea bags, 1 compartment for sugar, biscuits, etc., hinged lid

3 compartimentos para bolsitas de té, 1 compartimento para azúcar, galletas, etc. tapa abatible

3 compartiments pour sachets de thé, 1 compartiment pour sucre, biscuits, etc., couvercle abatible

	cm	↑ cm	€
11563	22 x 17	9	21,00

**NEW** SAMOWAR

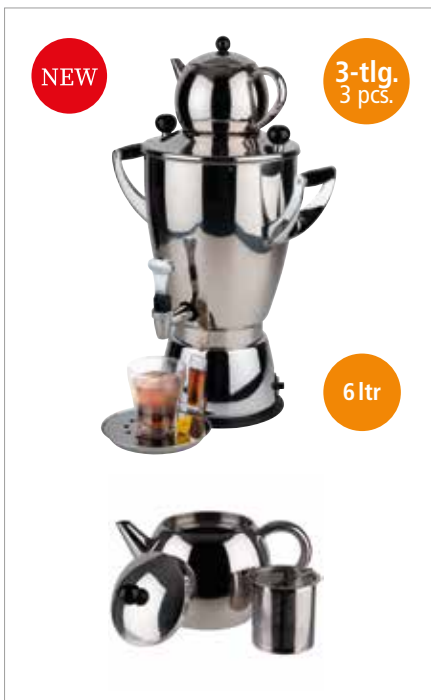

**Samovar**  
samovar  
samovar  
samovar

**3-tlg. 3 pcs.**

**6 ltr**

3-teiliges Set:  
 • 1 Samovar, 230V, 50/60Hz, 1.800W (6 Liter)  
 • 1 Teekanne (1,1 Liter)  
 • 1 Tropfenschale

3 pcs. set:  
 • 1 samovar, 230V, 50/60Hz, 1.800W (6 ltr.)  
 • 1 teapot (1,1 ltr.)  
 • 1 drip tray

set de 3:  
 • 1 samovar, 230V, 50/60Hz, 1.800W (6 L.)  
 • 1 tetera (1,1 L.)  
 • 1 bandeja recogegotas

set de 3:  
 • 1 samovar, 230V, 50/60Hz, 1.800W (6 L.)  
 • 1 théière (1,1 L.)  
 • 1 bac ramasse-gouttes

	cm	↑ cm	ltr.	€
12315	35 x 21	58	6	540,00

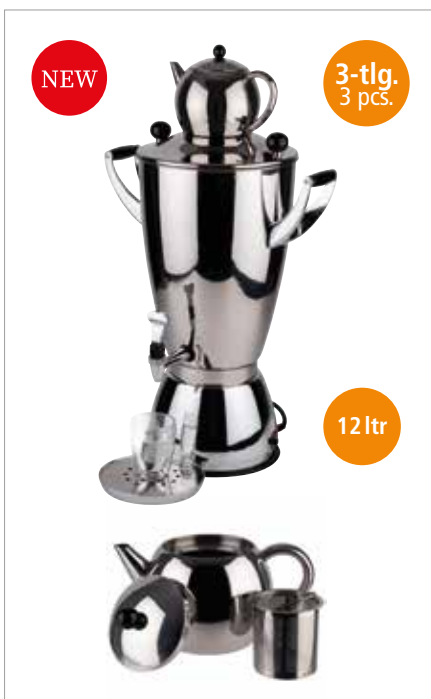

**Samovar**  
samovar  
samovar  
samovar

**3-tlg. 3 pcs.**

**12 ltr**

3-teiliges Set:  
 • 1 Samovar, 230V, 50/60Hz, 1.800W (12 Liter)  
 • 1 Teekanne (1,3 Liter)  
 • 1 Tropfenschale

3 pcs. set:  
 • 1 samovar, 230V, 50/60Hz, 1.800W (12 ltr.)  
 • 1 teapot (1,3 ltr.)  
 • 1 drip tray

set de 3:  
 • 1 samovar, 230V, 50/60Hz, 1.800W (12 L.)  
 • 1 tetera (1,3 L.)  
 • 1 bandeja recogegotas

set de 3:  
 • 1 samovar, 230V, 50/60Hz, 1.800W (12 L.)  
 • 1 théière (1,3 L.)  
 • 1 bac ramasse-gouttes

	cm	↑ cm	ltr.	€
12316	42 x 26	75	12	890,00

**NEW** TWINZ



**NEW**



„espresso size“

### Gläser, 2er Set „TWINZ“

glasses, 2 pcs. set  
vasos, set de 2  
verres, set de 2

**doppelwandig, ideal für Espresso**

glass, double-walled, ideal for espresso  
vidrio, doble pared, ideal para espresso  
verre, à double paroi, idéal pour l'espresso

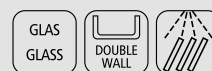

	Ø cm	↑ cm	ltr.	pcs.	€/ set
10370	6	6,5	0,08	2	8,00

**NEW**



„coffee and tea size“

### Gläser, 2er Set „TWINZ“

glasses, 2 pcs. set  
vasos, set de 2  
verres, set de 2

**doppelwandig, ideal für Kaffee oder Tee**

glass, double-walled, ideal für coffee or tea  
vidrio, doble pared, ideal para café o té  
verre, à double paroi, idéal pour le café ou le thé

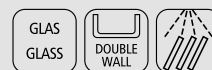

	Ø cm	↑ cm	ltr.	pcs.	€/ set
10371	8,5	8,5	0,23	2	10,00

**NEW**



„latte macchiato size“

### Gläser, 2er Set „TWINZ“

glasses, 2 pcs. set  
vasos, set de 2  
verres, set de 2

**doppelwandig, ideal für Latte Macchiato**

glass, double-walled, ideal for Latte Macchiato  
vidrio, doble pared, ideal para latte macchiato  
verre, à double paroi, idéal pour le latte macchiato

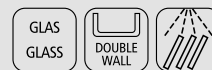

	Ø cm	↑ cm	ltr.	pcs.	€/ set
10372	8,5	14	0,38	2	12,00

**NEW** SNUG



**Espressotasse „SNUG“**

espresso cup  
taza de espresso  
tasse à espresso



Porzellan, Griff: 2 cm / porcelain, handle: 2 cm / porcelana, asa: 2 cm / porcelaine, poignée: 2 cm

	Ø cm	↑ cm	ltr.	Farbe / Colour	VE / unit	€/ pc.
16000	6	5,5	0,08		6	2,90
16001	6	5,5	0,08		6	2,90
16002	6	5,5	0,08		6	2,90



**Espressountertasse „SNUG“**

espresso saucer  
platillo de espresso  
soucoupe à espresso



Porzellan / porcelain / porcelana / porcelaine

	Ø cm	↑ cm	Farbe / Colour	VE / unit	€/ pc.
16009	11,5	2		6	2,80
16010	11,5	2		6	2,80
16011	11,5	2		6	2,80







**Kaffeetasse „SNUG“**

coffee cup  
taza de café  
tasse à café



Porzellan, Griff: 2 cm / porcelain, handle: 2 cm / porcelana, asa: 2 cm / porcelaine, poignée: 2 cm

	Ø cm	↑ cm	ltr.	Farbe / Colour	VE / unit	€ / pc.
16003	9,5	6	0,2		6	4,10
16004	9,5	6	0,2		6	4,10
16005	9,5	6	0,2		6	4,10



**Kaffeuntertasse „SNUG“**

coffee saucer  
platillo de café  
soucoupe à café



Porzellan / porcelain / porcelana / porcelaine

	Ø cm	↑ cm		Farbe / Colour	VE / unit	€ / pc.
16012	14,5	2,5			6	3,40
16013	14,5	2,5			6	3,40
16014	14,5	2,5			6	3,40



**Cappuccinotasse „SNUG“**

cappuccino cup  
taza de cappuccino  
tasse à cappuccino



Porzellan, Griff: 3 cm / porcelain, handle: 3 cm / porcelana, asa: 3 cm / porcelaine, poignée: 3 cm

	Ø cm	↑ cm	ltr.	Farbe / Colour	VE / unit	€ / pc.
16006	10,5	6,5	0,3		6	5,60
16007	10,5	6,5	0,3		6	5,60
16008	10,5	6,5	0,3		6	5,60



**Cappuccinountertasse „SNUG“**

cappuccino saucer  
platillo de cappuccino  
soucoupe cappuccino



Porzellan / porcelain / porcelana / porcelaine

	Ø cm	↑ cm		Farbe / Colour	VE / unit	€ / pc.
16015	15,5	2,5			6	3,80
16016	15,5	2,5			6	3,80
16017	15,5	2,5			6	3,80

# HOCHSTAPLER

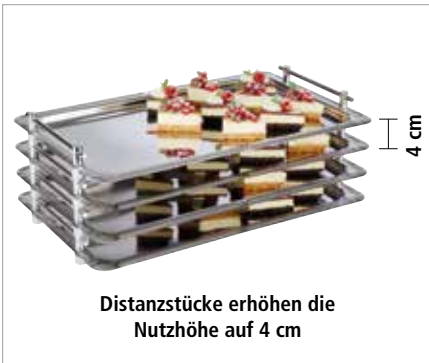

## GN 1/1 System-Tablett „PROFI LINE“

GN 1/1 tray  
GN 1/1 bandeja  
GN 1/1 plateau



Dekorrand, hochglanzpoliert, Griffe verchromt, Distanzstücke erhöhen die Nutzhöhe auf 4 cm  
decor edge, mirror polished, chrome plated handles, spacers increase the useful height to 4 cm  
borde decorado pulido brillante, asas cromadas, los separadores aumentan la altura útil a 4 cm  
bord avec reliefs poli brillant, poignées chromées, les entretoises portent la hauteur utile à 4 cm

	cm	↑ cm	GN	€
11300	53 x 32,5	5,5	1/1	46,00



## GN 1/1 System-Tablett „BUFFET-STAR“

GN 1/1 tray  
GN 1/1 bandeja  
GN 1/1 plateau



Rand hochglanzpoliert, Distanzstücke erhöhen die Nutzhöhe auf 4 cm  
mirror polished edge, spacers increase the useful height to 4 cm  
borde pulido brillante, los separadores aumentan la altura útil a 4 cm  
bord poli brillant, les entretoises portent la hauteur utile à 4 cm

	cm	↑ cm	GN	Griff / handle	€
11150	53 x 32,5	6,5	1/1	silver	37,00
11155	53 x 32,5	6,5	1/1	gold	40,00



## GN 1/1 System-Tablett „CLASSIC“

GN tray  
GN bandeja  
GN plat empilable système catering



Rand hochglanzpoliert, Distanzstücke erhöhen die Nutzhöhe auf 4 cm  
mirror polished edge, spacers increase the useful height to 4 cm  
borde pulido brillante, los separadores aumentan la altura útil a 4 cm  
bord poli brillant, les entretoises portent la hauteur utile à 4 cm

	cm	↑ cm	GN	€
11295	53 x 32,5	5,0	1/1	39,00



## GN 1/1 Haube „HOCHSTAPLER“

GN 1/1 cover  
GN 1/1 campana  
GN 1/1 cloche



glasklarer Kunststoff, Haube fixiert sich auf dem Tablett, nahezu bruchfest  
clear plastic, cover fixes itself on the tray, nearly unbreakable  
plástico transparente, la tapa se fija a la bandeja para que no se deslice, resistente a la rotura  
en plastique transparent, la cloche se fixe sur le dessous du plateau, résistant à la casse

	cm	↑ cm	fits to	GN	€
11305	53 x 32,5	9	11300, 11295	1/1	30,00



**GN Behälter „PROFI LINE“**

GN pan  
GN cubeta  
GN bac



	cm	↑ cm	GN	ltr.	€
11020	53,0 x 32,5	2,0	1/1	1,7	34,00
11040	53,0 x 32,5	4,0	1/1	3,4	37,00
11065	53,0 x 32,5	6,5	1/1	7,0	40,00
12065	32,5 x 26,5	6,5	1/2	3,3	26,00



**GN Tablett „PROFI LINE“**

GN tray  
GN bandeja  
GN plateau



mit glattem Rand / with smooth edge / borde liso / bord lisse

	cm	↑ cm	GN	€
11100	53,0 x 32,5	1,5	1/1	31,00
12100	32,5 x 26,5	1,5	1/2	17,80

mit Dekor-Rand / with decor-edge / con borde decorado / bords avec relief

	cm	↑ cm	GN	€
11000	53,0 x 32,5	1,5	1/1	31,00
12000	32,5 x 26,5	1,5	1/2	19,60

glatter schmaler Rand / smooth narrow edge / borde estrecho liso / bord étroit lisse

	cm	↑ cm	GN	€
11110	53,0 x 32,5	1,0	1/1	18,60



**Tablett „PROFI LINE“**

tray  
bandeja  
plateau



Dekorrand hochglanzpoliert  
decor edge mirror polished  
borde decorado pulido brillante  
contour relief poli brillant

	Ø cm	↑ cm	€
11032	32	2,5	21,00



**GN Abdeckhaube**

GN cover  
GN campana  
GN cloche



	cm	↑ cm	* mm	GN	€
11041	32,5 x 26,5	9,5	3	1/2	23,00
11042	53,0 x 32,5	9,5	3	1/1	32,00
11043	32,5 x 17,6	10,5	3	1/3	17,00
11044	53,0 x 16,2	10,5	3	2/4	23,00

## TRAYS STAINLESS STEEL



### Tablett „SCHÖNER ESSEN“

tray  
bandeja  
plateau



mit Dekorrand, Griffe Zinkdruckguss verchromt, genietet

with decor edge, handles zinc alloy chrome plated, riveted

borde decorado, asas de fundición inyectada de cinc cromado, remachadas

bord décor, poignées en zamac chromé, rivetées

	cm	↑ cm	€
00082	52 x 31,0	3,0	16,00
00081	60 x 36,0	3,0	22,00
00084	75 x 44,5	3,0	38,00



### Tablett „SCHÖNER ESSEN“

tray  
bandeja  
plateau



	cm	↑ cm	GN	€
00383	35,0 x 24,0	1,0		7,60
00382	42,0 x 31,0	1,0		10,60
00381	50,0 x 36,0	1,0		15,00
00384	63,5 x 44,5	1,0		29,00
00385	60,0 x 40,0	1,0		27,00
00388	53,0 x 32,5	1,0	1/1	17,00

leichte Ausführung 0,5 mm / light model / modelo ligero / qualité légère

	cm	↑ cm	€
03824	42,0 x 31,0	1,0	9,60



### Tablett mit Haube „SCHÖNER ESSEN“

tray with cover  
bandeja con campana  
plateau avec cloche



	cm	↑ cm	€
38202	42 x 31	8	16,80

Haube / cover / campana / cloche

	cm	↑ cm	€
08201	36,5 x 26,0	7,5	5,40



**Tablett „FINESSE“**

tray  
bandeja  
plateau

verchromte Messinggriffe / chrome plated brass handles / asas plateadas de latón / poignées en laiton chromées



	cm	↑ cm	€
01712	44 x 31	1,5	22,40



01324 oval

**Tablett „FINESSE“**

tray  
bandeja  
plateau



	cm	↑ cm	€
01322	42 x 30	2,5	14,90
01323	50 x 36	2,5	21,60
01324	60 x 41	2,5	30,00



01338

**Tablett „FINESSE“**

tray  
bandeja  
plateau



	Ø cm	↑ cm	€
01332	32,0	1,0	9,40
01335	35,0	1,0	11,00
01338	38,0	1,0	12,40
01348	48,0	1,0	24,00



01311

**Tablett „FINESSE“**

tray  
bandeja  
plateau



	cm	↑ cm	€
01314	30 x 24	1,0	8,60
01313	35 x 24	1,0	9,80
01317	39 x 26	1,0	11,00
01312	42 x 31	1,0	12,40
01318	48 x 30	1,0	11,80
01311	50 x 38	1,0	17,20
01310	58 x 42	1,0	29,00
01309	68 x 48	1,0	41,00

## TRAYS STAINLESS STEEL



### Schale

bowl  
cuenco  
bol

#### ingerollter Rand

rolled edge  
borde enrollado  
bord roulé



	cm	↑ cm	ltr.	€
40110	26,5 x 18,5	4,0	0,8	8,60



### Servierpfanne

pan  
fuente para la mesa  
plat pour la table

#### mit vergoldeten Edelstahlgriffen, 1 mm dick

with gold-plated stainless steel handles, 1 mm thick  
con asas doradas de acero inoxidable de 1 mm de grosor  
avec poignées dorées en acier inox, 1 mm d'épaisseur



	cm	↑ cm	ltr.	€
61190	19	3,5	0,7	16,40
61280	28	4,0	2,0	24,00
61400	40	5,0	4,5	64,00
60270	26,5 x 19,5	3	0,8	18,40
60310	31,0 x 21,5	3	1,2	23,00



### Edelstahltablett „FOCUS“

tray  
bandeja  
plateau



	cm	↑ cm	€
09010	43,5 x 32,5	1,5	20,00

#### Rolltophaube „FOCUS“ / rolltop cover / campana abatible / cloche basculante

	cm	↑ cm	€
09013	44 x 33,5	17	28,00



### Tablett „ELEGANCE“

tray  
bandeja  
plateau



	cm	↑ cm	€
02311	48 x 30	1,0	17,00



**Tablett „VINTAGE“**

tray  
bandeja  
plateau

Antik-Edelstahl-Look  
stainless steel antique look  
acero estilo antiguo  
acier style antique



	cm	↑ cm	€
30130	26,0 x 13,5	1,5	8,00
30131	34,0 x 18,0	1,5	13,20
30132	38,0 x 26,5	1,5	21,00
30133	25,5 x 16,0	3,0	16,00
30134	32,5 x 21,5	2,0	15,00

passende Schälchen / fitting bowls / cuencos adecuados / bols appropriés



	Ø cm	↑ cm	ltr.	€
40655	7,5	5,5	0,17	3,20
40656	7,5	10,0	0,35	4,00

Wachspapier / greaseproof paper squares / papel alimenticio / papier alimentaire

	cm	pcs.		€ / set
40670	42 x 25	500	Motiv: Zeitung	59,00



Servierbeispiel  
presentation example



**Tablett „TREND“**

baking sheet  
bandeja  
plateau

ein Backblech wird zum Serviertablett  
a baking sheet which becomes a serving tray  
una bandeja de hornear que se convierte en una bandeja de servir  
un moule qui devient un plateau de service



	cm	↑ cm	€
13380	32 x 21,5	2	10,60

## TRAYS STAINLESS STEEL



### Serviertablett „KAFFEEHAUS“

tray  
bandeja  
plateau

hochglanzpoliert, stabiler Rand eingerollt  
mirror polished, stable edge rolled in  
pulido brillante, borde estable enrollado  
poli brillant, bord stable enroulé



	cm	↑ cm	€
30148	Ø 27	1,5	6,00
30149	30 x 15,5	1,5	6,80

passende Hauben / cover / campana / cloche



	cm	↑ cm	suitable for	€
11055	Ø 23	12,0	30148	5,70
11056	26 x 12	10,0	30149	7,90



Servierbeispiel  
presentation example



### Serviertablett „KAFFEEHAUS“

tray  
bandeja  
plateau

matt poliert, oval, Rand eingerollt  
matt polished, oval, rolled edge  
pulido mate, oval, borde enrollado  
poli mat, ovale, bord enroulé



	cm	↑ cm	€
30111	20,0 x 14,5	0,5	für Zucker und Sahne / for sugar and cream 4,70
30112	26,5 x 19,5	0,5	für eine Tasse / for one cup 7,00
30113	29,0 x 22,0	0,5	für zwei Tassen / for two cups 7,50

Antik-Edelstahl-Look  
stainless steel antique look  
acero estilo antiguo  
acier style antique



	cm	↑ cm	€
30140	20,0 x 14,5	1,0	für Zucker und Sahne / for sugar and cream 5,00
30141	26,5 x 19,5	1,0	für eine Tasse / for one cup 7,60
30142	29,0 x 22,0	1,0	für zwei Tassen / for two cups 9,80



### Serviertablett „KAFFEEHAUS“

tray  
bandeja  
plateau

hochglanzpoliert, oval, Rand eingerollt  
mirror polished, oval, rolled edge  
pulido brillante, ovalado, borde enrollado  
poli brillant, ovale, bord enroulé



	cm	↑ cm	€
30115	20,0 x 14,5	0,5	für Zucker und Sahne / for sugar and cream para azúcar y crema / pour le sucre et la crème 4,70
30116	26,5 x 19,5	0,5	für eine Tasse / for one cup para una taza / pour une tasse 7,00
30117	29,0 x 22,0	0,5	für zwei Tassen / for two cups para dos tazas / pour deux tasses 7,50





Serviertablett „KAFFEEHAUS“

tray  
bandeja  
plateau

**matt poliert, Rand eingerollt**

matt polished, rolled edge

pulido mate, borde enrollado

poli mat, bord enrollé



	cm	↑ cm	€
30118	21,5 x 13	1,5	7,90
30119	23,0 x 23	1,5	10,90



Serviertablett „KAFFEEHAUS“

tray  
bandeja  
plateau



	cm	↑ cm	Farbe / Colour	€
84251	26,0 x 20,0	1,5	■	4,80
84253	28,5 x 21,5	1,5	■	5,40



Serviertablett „KAFFEEHAUS“

tray  
bandeja  
plateau

**Innenfläche ziseliert, Rand eingerollt**

chiselled inner surface, rolled edge

superficie interior cincelada, borde enrollado

surface intérieure ciselée, bord enrollé



	cm	↑ cm	VE / unit	€ / pc.
30114	30 x 22	1,0	48	3,00

## TRAYS



### Tablett mit Haube „FINESSE“

tray with cover  
bandeja con campana  
plateau avec cloche

**2-teilig: Tablett aus Edelstahl + Haube**

2 pcs.: stainless steel tray + cover  
set de 2: bandeja de acero inoxidable + campana  
set de 2: plateau en acier inox + cloche



	cm	↑ cm	€
13122	42 x 31	8,5	22,00



### Tablett mit Haube „FINESSE“

tray with cover  
bandeja con campana  
plateau avec cloche

**2-teilig: Tablett aus Edelstahl + Haube**

2 pcs.: stainless steel tray + cover  
set de 2: bandeja de acero inoxidable + campana  
set de 2: plateau en acier inox + cloche



	Ø cm	↑ cm	€
13622	22	9,5	7,80



### Tablett mit Haube „FINESSE“

tray with cover  
bandeja con campana  
plateau avec cloche

**2-teilig: Tablett aus Edelstahl + Haube**

2 pcs.: stainless steel tray + cover  
set de 2: bandeja de acero inoxidable + campana  
set de 2: plateau en acier inox + cloche



	Ø cm	↑ cm	Ø cm Hauben / cover	€
13382	38	12	30	22,40
13385	38	13	33	23,60



### Tablett mit Haube

tray with cover  
bandeja con campana  
plateau avec cloche

**2-teilig: Tablett aus Edelstahl, hochglanzpoliert + Haube**

2 pcs.: stainless steel tray, mirror polished + cover  
set de 2: bandeja de acero inoxidable, pulido brillante + campana  
set de 2: plateau en acier inox, poli brillant + cloche



	Ø cm	↑ cm	€ / set
00827	27	12,5	13,00



### Tablett mit Haube

tray with cover  
bandeja con campana  
plateau avec cloche

**2-teilig: Tablett aus Edelstahl, hochglanzpoliert + Haube**

2 pcs.: stainless steel tray, mirror polished + cover  
set de 2: bandeja de acero inoxidable, pulido brillante + campana  
set de 2: plateau en acier inox, poli brillant + cloche



	cm	↑ cm	€ / set
00828	30 x 15,5	10,5	14,20

**Tablett mit Haube „ELEGANCE“**

tray with cover  
bandeja con campana  
plateau avec cloche

**2-teilig: Tablett aus Edelstahl + Haube**

2 pcs.: stainless steel tray + cover  
set de 2: bandeja de acero inoxidable + campana  
set de 2: plateau en acier inox + cloche

	cm	↑ cm	€
00064	33 x 17	10	9,40
00067	25 x 19	7	9,40

**Haube für 00064 / cover for 00064 / campana para 00064 / cloche pour 00064**

	€
06401	3,70

**Haube für 00067 / cover for 00067 / campana para 00067 / cloche pour 00067**

	€
06701	2,80

**Tortenplatte**

cake plate  
bandeja tartas  
plat à gâteau

**2-teilig: Tablett aus Edelstahl + Haube**

2 pcs.: stainless steel tray + cover  
set de 2: bandeja de acero inoxidable + campana  
set de 2: plateau en acier inox + cloche

	Ø cm	↑ cm		€ / set
00065	30	11	mit 1 Haube / with 1 cover	9,00
00652	30	7 + 11	mit 2 Hauben / with 2 cover	11,60

**Tortenplatte „BAROCK“**

cake plate  
bandeja tartas  
plat à gâteau

**2-teilig: Tortenplatte mit Barock-Rand + Haube**

2 pcs.: cake plate with decor edge „Barock“ + cover  
set de 2: porta tartas, borde decor „Barock“ + campana  
set de 2: plateau bord décor „Barock“ + cloche

	Ø cm	↑ cm	€ / set
06503	32	10	12,00

**Frischhaltehaube / cover / campana / cloche**

	Ø cm	↑ cm	€
06510	30	11,5	5,90

## TRAYS



2 tlg.  
2 pcs.

### Tablett mit Haube

tray with cover  
bandeja con campana  
plateau avec cloche



2 teilig: Tablett aus geöltem Buchenholz (Ø 18,5 cm, H: 2,5 cm) + Glas-Haube (Ø 16 cm, H: 22,5 cm)

2 pcs.: tray of oiled beech wood + glass cover

set de 2: bandeja de madera haya + campana de cristal

set de 2 : plateau en bois de hêtre + cloche en verre

	Ø cm	↑ cm	€/ set
00830	18,5	24	36,00



2 tlg.  
2 pcs.

### Tablett mit Haube, 2-teilig

tray with cover, 2 pcs.  
bandeja con campana, set de 2  
plateau avec cloche, set de 2



Tablett aus Bambus, ölimprägniert + Haube

bamboo tray, oil-impregnated + cover

bandeja de bambú, impregnada de aceite + campana

plateau en bambou, imprégné d'huile + cloche

	Ø cm	↑ cm	€/ set
00825	25	13,5	11,00



2 tlg.  
2 pcs.

### Tablett mit Haube, 2-teilig

tray with cover, 2 pcs.  
bandeja con campana, set de 2  
plateau avec cloche, set de 2



Tablett aus Bambus, ölimprägniert + Haube

bamboo tray, oil-impregnated + cover

bandeja de bambú, impregnada de aceite + campana

plateau en bambou, imprégné d'huile + cloche

	cm	↑ cm	€/ set
00826	28 x 14	11,5	9,80



2 tlg.  
2 pcs.

### Tablett mit Haube, 2 teilig

tray with cover, 2 pcs.  
bandeja con campana, set de 2  
plateau avec cloche, set de 2



Tablett aus Bambus, ölimprägniert + Haube

bamboo tray, oil-impregnated + cover

bandeja de bambú, impregnada de aceite + campana

plateau en bambou, imprégné d'huile + cloche

	Ø cm	↑ cm	€/ set
00822	20,5	10	8,60



2 tlg.  
2 pcs.

00820

00821

Kastenkuchengröße  
box-cake size

### Tablett mit Haube, 2 teilig

tray with cover, 2 pcs.  
bandeja con campana, set de 2  
plateau avec cloche, set de 2



Tablett aus Bambus, ölimprägniert + Haube

bamboo tray, oil-impregnated + cover

bandeja de bambú, impregnada de aceite + campana

plateau en bambou, imprégné d'huile + cloche

	cm	↑ cm	€/ set
00820	24 x 18,5	8	7,40
00821	32 x 16,5	11	9,80



### Rolltop-Set

rolltop set  
set rolltop  
set cloche à fromage



**2-teilig: Tablett + Rolltophaube glasklar, rutschfeste Haubenfixierung, klappbar**

2 pcs.: tray + rolltop cover, cover non-slip fixed, mountable  
set de 2: bandeja + campana abatible fijación antideslizante, montable  
set de 2: plateau + cloche abattante, fixation antidérapants, montable

	Ø cm	↑ cm	€/ set
09080	38	24	39,00
09099	50	28	84,00



### Rolltop-Set, 3-teilig

rolltop set, 3 pcs.  
rolltop, set de 3  
rolltop, set de 3



**1 Edelstahltablett Ø 38 cm + 1 Naturschieferplatte Ø 33 cm + 1 Rolltophaube Ø 38 cm**

1 stainless tray Ø 38 cm + 1 natural slate tray Ø 33 cm + 1 rolltop cover Ø 38 cm  
1 bandeja de acero inoxidable Ø 38 cm + 1 bandeja de pizarra natural Ø 33 cm + 1 tapa abatible Ø 38 cm  
1 plat inox Ø 38 cm + 1 plat ardoise naturelle Ø 33 cm + 1 cloche Ø 38 cm

	Ø cm	↑ cm	€/ set
01000	38	24	48,50



### Kaviarkühler

caviar cooler  
enfriador de caviar  
rafraîchisseur de caviar



**4-teilig: 1 Edelstahlschale, 1 Halter, 1 Glasschale, 1 Edelstahldeckel**

4 pcs.: 1 stainless steel bowl, 1 holder, 1 glass bowl Ø 10 cm, 1 stainless steel cover  
set de 4: 1 bol de acero inoxidable, 1 soporte, 1 bol de vidrio Ø 10 cm, 1 tapa de acero inoxidable  
set de 4: 1 bol en acier inox, 1 support, 1 bol en verre Ø 10 cm, 1 couvercle en acier inox

	Ø cm	↑ cm	€
01699	18	12	56,00



### Serviertöpfchen „MUMBAI“

small serving pot  
olla pequeña de servir  
marmite petite de servir



**gehämmerte Oberfläche**

hammered surface  
superficie martillada  
surface martelée

	Ø cm	↑ cm	ltr.	Griff / handle cm	€
40186	9,5	5,5	0,30	2,5	8,60
40187	13,5	5,0	0,55	3,0	9,80
40188	15,5	5,0	0,75	3,0	11,60

## TRAYS



00396 round

00398 oval

GN 1/1 00395

### Partyplatte „CLASSIC“

partytray  
bandeja party  
plateau party

**Rand eingerollt**

rolled edge  
borde enrollado  
bord enroulé



	cm	↑ cm	GN		VE / unit	€ / pc.
00396	Ø 35	1,5	-	round	48	5,20
00398	46,0 x 34,0	1,5	-	oval	48	5,20
00399	41,0 x 31,0	1,5	-		48	5,20
00389	35,4 x 32,5	1,5	2/3		48	5,00
00395	53,0 x 32,5	1,5	1/1		36	8,20



00393 round

00391 oval

00392

### Partyplatte „CLASSIC“

partytray  
bandeja party  
plateau party

**Rand eingerollt**

rolled edge  
borde enrollado  
bord enroulé



	cm	↑ cm		VE / unit	€ / pc.
00393	Ø 35	1,5	round	48	5,20
00391	46 x 34	1,5	oval	48	5,20

	cm	↑ cm	GN	VE / unit	€ / pc.
00392	41 x 31	1,5	-	48	5,20
00394	53 x 32,5	1,5	1/1	48	8,20





### Serviertablett „HAPPY HOUR“

tray  
bandeja  
plateau



rutschfeste Oberfläche / non-slip surface / superficie antideslizante / surface antidérapante

	Ø cm	↑ cm	Farbe / Colour	€
00510	32	1,5	■	23,00
00511	38	1,5	■	28,00
00515	43	1,5	■	32,00



### Bierglasträger „NON SLIP“

beer rack  
bandeja para cerveza  
porte verre à bière



rutschfeste Oberfläche / non-slip surface / superficie antideslizante / surface antidérapante

	Ø cm	↑ cm	Farbe / Colour	€
00500	36	3,5	■	21,00
00506	28 x 20	1,5	■	9,60



### Tablett „GASTRO“

tray  
bandeja  
plateau



rutschfeste Oberfläche / non-slip surface / superficie antideslizante / surface antidérapante

	Ø cm	↑ cm	Farbe / Colour	€
00547	27,5	2	■	7,60
00548	35,5	2	■	9,60
00549	40,5	2	■	11,40



### Tablett „BISTRO“

tray  
bandeja  
plateau



rutschfest, mit 2 Griffmulden und Stapelrand

non-slip, two open handles, stackable edge  
antideslizante, con 2 asas y borde apilable  
antidérapant, avec 2 poignées et bord d'empilage

	Ø cm	↑ cm	Farbe / Colour	€
84045	35,5	4,5	■	26,00



### Serviertablett „NON SLIP“

tray non-slip  
bandeja  
plateau



rutschfeste Oberfläche / non-slip surface / superficie antideslizante / surface antidérapante

	cm	↑ cm	GN	Farbe / Colour	€
00502	53,0 x 32,5	1,5	1/1	■	25,00
00508	46,0 x 36,0	2,0		■	22,90



# FAST FOOD TRAYS



**Fast Food-Tablett**  
 snack tray  
 bandeja autoservicio y snacks  
 plateau self-service et snacks



	cm	↑ cm	GN	Farbe / Colour	€
00530	35 x 27,0	2			3,50
00535	41 x 30,5	2			4,70
00540	45 x 35,5	2			5,90
00552	53 x 32,5	2	1/1		7,20

	cm	↑ cm	GN	Farbe / Colour	€
00531	35 x 27,0	2			3,50
00536	41 x 30,5	2			4,70
00541	45 x 35,5	2			5,90
00553	53 x 32,5	2	1/1		7,20

	cm	↑ cm	GN	Farbe / Colour	€
00532	35 x 27,0	2			3,50
00537	41 x 30,5	2			4,70
00542	45 x 35,5	2			5,90
00554	53 x 32,5	2	1/1		7,20

	cm	↑ cm	GN	Farbe / Colour	€
00533	35 x 27,0	2			3,50
00538	41 x 30,5	2			4,70
00543	45 x 35,5	2			5,90
00555	53 x 32,5	2	1/1		7,20

	cm	↑ cm	GN	Farbe / Colour	€
00534	35 x 27,0	2			3,50

	cm	↑ cm	GN	Farbe / Colour	€
00539	35 x 27,0	2			3,50



stapelbar  
 stackable



# CAKE STANDS



## Servier- und Tortenplatte „CASUAL“

cake plate  
porta pasteles  
présentoir à gâteaux



	Ø cm	↑ cm		€
83890	31	8		28,60
83891	31	16		36,00
	cm	↑ cm		€
83892	31 x 31	8		32,00
83893	31 x 31	16		39,00



## Servier- und Tortenplatte

cake stand  
porta pasteles  
présentoir à gâteaux



**Rand fixiert die Haube, mit Antirutschfüßchen**  
carved edge fixes the cover, with non-slip feet  
ranura para fijar bien la campana, con pies antideslizantes  
bord rainuré pour maintenir ferme la cloche, avec pieds antidérapants

	Ø cm	↑ cm	Farbe / Colour	fits to cover	€
00468	31	3,5	White	06520	18,40
00469	31	3,5	Black	06520	18,40



## CAKE STANDS

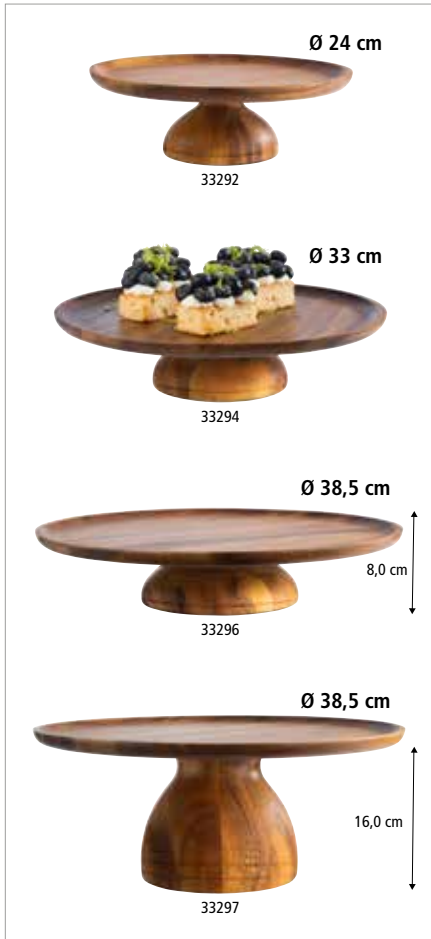

### Servier- und Tortenplatte „ACACIA“

cake stand  
porta pasteles  
présentoir à gâteaux

Akazienholz geölt, möbelschonende Unterseite  
acacia wood oiled, furniture-friendly underside  
madera de acacia aceitada, con base anti rayaduras  
bois d'acacia huilé, avec revêtement antirayures



	Ø cm	↑ cm	€
33292	24,0	8	50,00
33293	24,0	16	65,00
33294	33,0	8	70,00
33295	33,0	16	96,00
33296	38,5	8	86,00
33297	38,5	16	112,00

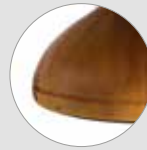

mit Rille  
with groove

Frischhaltehaube / cover / campana / cloche



	Ø cm	↑ cm	fits to	€
06519	21	17	33292, 33293	30,00
06520	30	22	33294, 33295	37,00
06521	36	27	33296, 33297	74,00



drehbar  
rotating

### Servier- und Tortenplatte

cake stand  
porta pasteles  
présentoir à gâteaux

matt poliert, drehbar, möbelschonende Unterseite  
matt polished, rotating, furniture-friendly underside  
pulido mate, giratoria, con base anti rayaduras  
poli mat, pivotant, avec revêtement antirayures



	Ø cm	↑ cm	€
00463	30,5	9	47,00



### Servier- und Tortenplatte

cake stand  
porta pasteles  
présentoir à gâteaux

matt poliert / matt polished / pulido mate / poli mat



	Ø cm	↑ cm	€
00046	31	3	15,00



### Auslagen- / Kuchenplatte

display / cake plate  
expositor / plato para tartas  
présentoir / assiette à gâteau

ideale Größe für Baumkuchen / Stollen  
ideal size for Baumkuchen / Stollen  
tamaño ideal para Baumkuchen / Stollen  
taille idéale pour Baumkuchen / Stollen



	cm	↑ cm	€
00047	40 x 16	2,5	14,95

# SUPER DOME



## Frischhaltehaube „SUPER DOME“

cover  
campana  
cloche



schwere, glasklare Qualität  
stable, crystal clear quality  
muy resistente y transparencia cristalina  
haute résistance et transparence

	Ø cm	↑ cm	€
06525	30	40	74,00

passende Servier-/Tortenplatten / suitable cake stands / porta pasteles compatibles /  
présentoirs à gâteaux compatibles

	Ø cm	↑ cm	fits to	Farbe / Colour	€
00468	31,0	3,5	06525		18,40
33294	33,0	8,0	06525		70,00
33295	33,0	16,0	06525		96,00



Präsentationsmöglichkeiten  
presentation examples



## Frischhaltehaube

cover  
campana  
cloche



schwere, glasklare Qualität  
stable, crystal clear quality  
calidad estable y transparencia cristalina  
qualité stable et clarté cristalline

	Ø cm	↑ cm	fits to	€
06519	21	17		30,00
06520	30	22	84177, 83891, 83890, 83884, 998, 975, 469, 468, 463, 46	37,00
06521	36	27		74,00

# NATURAL SLATE



**EXTRA STRONG**  
6-9 mm thickness

Naturschiefer speichert auf natürliche Weise Kälte besonders gut. Die Kanten der Platten sind gebrochen und nicht gesägt.

Natural slate stores cold particularly well in a natural way. The edges of the panels are broken and not sawn.

La pizarra natural almacena el frío especialmente bien de forma natural. Los bordes de las bandejas están rotos y no aserrados.

L'ardoise naturelle stocke particulièrement bien le froid de manière naturelle. Les bords des plateaux sont brisés et non sciés.



3 tlg.  
3 pcs.

## Kühlbox „SLATE“ refrigerated buffet display expositor buffet frío plateau buffet froid

3-teilig, bestehend aus: 1 Basis aus schwarzem Polystyrol,  
1 Naturschieferplatte, 1 Kühlakku (ohne Haube)  
3 pcs., set consists of: 1 base made of black polystyrene, 1 natural slate tray,  
1 cooler (without cover)

set de 3 compuesto por: 1 soporte de poliestireno negro, 1 bandeja de pizarra natural,  
1 acumulador de frío (sin campana)

set de 3 composé de: 1 support en polystyrène noir, 1 plateau en ardoise naturelle,  
1 accumulateur de froid (sans couvercle)



	cm	↑ cm	€
11645	58 x 38	6,5	80,00

### Naturschieferplatte / natural slate tray / bandeja de pizarra natural / plateau ardoise naturelle

	cm	* mm	€
00979	58 x 38	6 - 9	19,00

### Kühlakku / cooler / acumulador de frío / accumulateur de froid

	cm	↑ cm	€
10782	41 x 21	2,5	16,00

### Basis / base / soporte / support

	cm	↑ cm	€
11619	52 x 32	5,5	49,00

### GN Rolltophaube mit schwarzem Griff / GN rolltop cover with black handle / GN campana rolltop con mango negro / GN cloche rolltop avec poignée noire

	cm	↑ cm	GN	€
11075	53 x 32,5	19	1/1	62,00



## GN 1/1 Naturschieferplatte „HOCHSTAPLER“

GN 1/1 natural slate tray  
GN 1/1 bandeja de pizarra natural  
GN 1/1 plat ardoise naturelle



	cm	↑ cm	* mm	€
00966	53 x 32,5	6	6 - 9	35,80

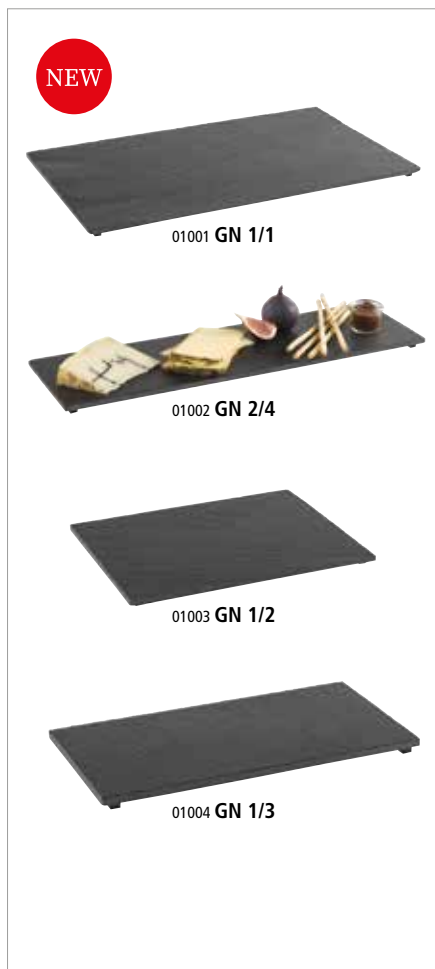

Griffe verchromt, 4 cm Nutzhöhe  
chrome plate handles, 4 cm distance

**GN Naturschieferplatte**

GN natural slate tray  
GN bandeja pizarra natural  
GN plat ardoise naturelle



möbelschonende Unterseite, gerade Kanten

non-scratching undersurface, straight edges

base anti rayaduras, bordes rectos

avec revêtement antirayures, bords rectilignes

	cm	✱ mm	GN	€
01001	53 x 32,5	6 - 9	1/1	15,80
01002	53 x 16,2	6 - 9	2/4	6,50
01003	32,5 x 26,5	6 - 9	1/2	8,80
01004	32,5 x 17,6	6 - 9	1/3	5,40

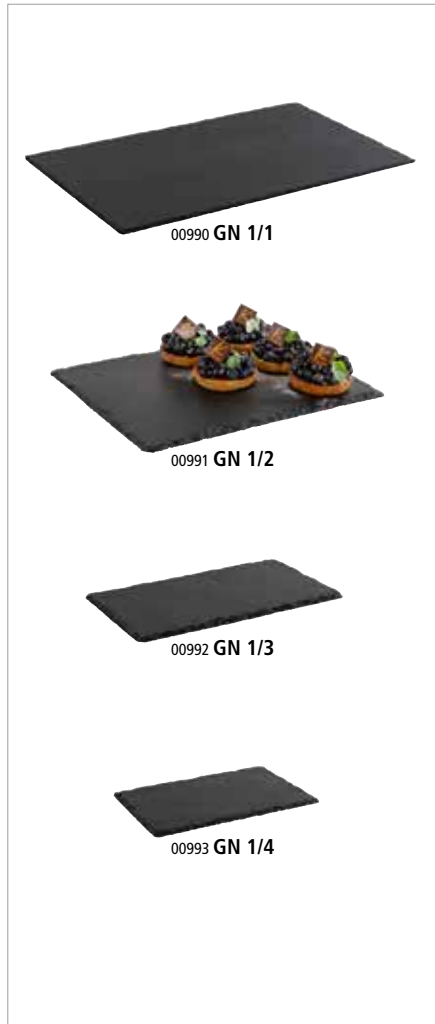

gerade Kanten  
straight edges

**GN Naturschieferplatten**

GN natural slate tray  
GN bandeja de pizarra natural  
GN plat ardoise naturelle



	cm	✱ mm	GN	€
00990	53,0 x 32,5	6 - 9	1/1	15,80
00991	32,5 x 26,5	6 - 9	1/2	8,80
00992	32,5 x 17,6	6 - 9	1/3	5,40
00993	26,5 x 16,2	6 - 9	1/4	5,00
00973	53,0 x 16,2	6 - 9	2/4	6,50

# SERVING BOARDS | NATURAL SLATE



**Naturschieferplatte**  
 natural slate tray  
 bandeja de pizarra natural  
 plat ardoise naturelle



	cm	✦ mm		€
00996	45 x 30	6 - 9		12,60
00979	58 x 38	6 - 9	mit Safrille / with juice groove	19,00

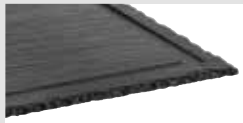

00979 mit Safrille  
 00979 with juice groove



**Naturschieferplatte**  
 natural slate tray  
 bandeja de pizarra natural  
 plat ardoise naturelle



	cm	✦ mm		€
00994	25 x 25	6 - 9		6,40
00995	30 x 30	6 - 9		9,50



**Naturschieferplatte**  
 natural slate  
 bandeja de pizarra natural  
 plateau ardoise naturelle



	cm	✦ mm		€
00941	24,0 x 15,0	6 - 9		4,20
00942	26,5 x 20,5	6 - 9		6,40
00943	47,0 x 10,0	6 - 9		6,40
00988	30,0 x 12,0	6 - 9		4,30

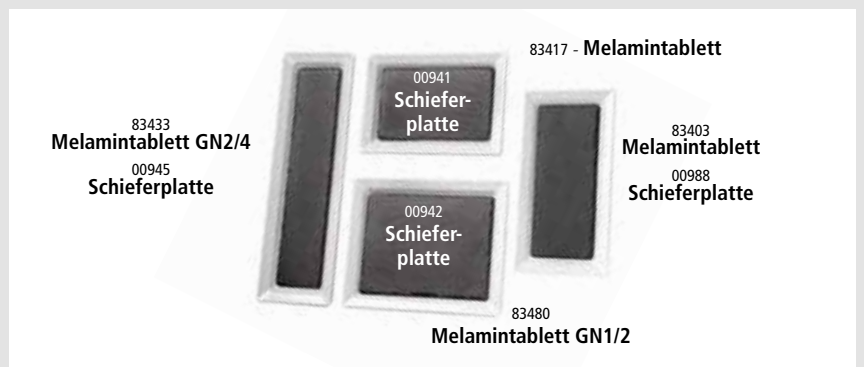

**Naturschieferplatte**

natural slate tray  
bandeja pizarra natural  
plat ardoise naturelle

mit Safrille, Ø 9,5 cm Aussparung  
with juice groove, with hole Ø 9,5 cm  
con ranura para líquidos, con agujero Ø 9,5 cm  
avec rigole, avec trou Ø 9,5 cm



	cm	mm	€
00947	33 x 24	6 - 9	10,00



mit Safrille  
with juice groove

Wachspapier / greaseproof paper squares / papel alimenticio / papier alimentaire

	cm	pcs.	Motiv: Zeitung	€
40670	42 x 25	500		59,00

Servier-Frittierkorb / fry baskets / cestitas para el servicio mesa / paniers pour le service sur table

	Ø cm	↑ cm	Griff / handle cm	Farbe / Colour	€
40601	9	8,5	9,0	stainless steel	11,20
40603	9	8,5	9,0	copper	13,00
40625	9	8,5	9,0	black matt	13,60

**Naturschieferplatte**

natural slate tray  
bandeja pizarra natural  
plat ardoise naturelle

mit 3 x Aussparungen, Ø 6 cm  
with 3 holes, Ø 6 cm  
con 3 agujeros, Ø 6 cm  
avec 3 trous, Ø 6 cm



	cm	mm	€
00987	28 x 10	6 - 9	5,80

**Naturschieferplatte**

natural slate tray  
bandeja pizarra natural  
plat ardoise naturelle

mit Aussparung, Ø 6 cm  
with hole Ø 6 cm  
con agujero Ø 6 cm  
avec trou Ø 6,0 cm



	cm	mm	€
00986	25 x 12	6 - 9	4,20

**Naturschieferplatte / Untersetzer**

natural slate tray  
bandeja de pizarra natural  
plateau ardoise naturelle

mit 2 Aussparungen, Ø 6 cm  
with 2 holes Ø 6 cm  
con 2 agujeros Ø 6 cm  
avec 2 trous Ø 6 cm



	cm	mm	€
00971	15 x 8	6 - 9	3,40

## SERVING BOARDS | NATURAL SLATE



### Naturschieferplatte „STARTER“

natural slate tray  
bandeja de pizarra natural  
plat ardoise naturelle



	cm	✱ mm	€
00937	20 x 10	6 - 9	3,10



00969

### Naturschieferplatte

natural slate tray  
bandeja de pizarra natural  
plat ardoise naturelle



	Ø cm	✱ mm	€
00968	22	6 - 9	5,20
00969	28	6 - 9	7,30
00998	33	6 - 9	8,70
00999	38	6 - 9	12,80



Präsentationsmöglichkeit  
presentation example



### Tortenplatte / Servierplatte

cake stand  
soporte para pastel  
présentoir à gâteaux



**drehbar**  
rotatable  
giratorio  
rotatif

	Ø cm	↑ cm	✱ mm	€
00975	32	2,5	6 - 9	18,40



drehbare Servierplatte  
rotatable cake stand



3 tlg.  
3 pcs.

### Rolltop-Set

rolltop set  
rolltop set  
rolltop set



- 3-teilig: • 1 Edelstahltablett Ø 38 cm  
• 1 Naturschieferplatte Ø 33 cm  
• 1 Rolltophaube Ø 38 cm
- 3 pcs.: • 1 stainless steel tray Ø 38 cm  
• 1 natural slate tray Ø 33 cm  
• 1 rolltop cover Ø 38 cm
- set de 3: • 1 bandeja de acero inoxidable Ø 38 cm  
• 1 bandeja de pizarra natural Ø 33 cm  
• 1 campana abatible Ø 38 cm
- set de 3: • 1 plateau en acier inox 38 cm  
• 1 plateau ardoise naturelle 33 cm  
• 1 cloche basculante 38 cm

	Ø cm	↑ cm	€ / set
01000	38	24	48,50



**3-stufige Etagère**

3-tier tray  
bandeja con tres alturas  
étagère carré 3 hauteurs

Naturschiefer, Akazienholz  
natural slate tray, wood akazie  
bandeja de pizarra natural, madera de acacia  
plateau ardoise naturelle, bois d'acacia



	∅ cm	↑ cm	* mm	€
00960	30 / 25 / 20	34	6 - 9	30,00

**2-stufige Etagère**

2-tier tray  
bandeja dos alturas  
étagère carré 2 hauteurs

Naturschiefer  
natural slate tray  
bandeja de pizarra natural  
plateau ardoise naturelle



	∅ cm	↑ cm	* mm	€
00989	25 / 20	24	6 - 9	15,30

**Naturschieferplatte**

natural slate tray  
bandeja de pizarra natural  
plateau ardoise naturelle

2-teilig: Naturschieferplatte mit Glashaube

2 pcs.: natural slate tray with glass cover  
set de 2: bandeja de pizarra natural con tapa de cristal  
set de 2: plateau ardoise naturelle avec cloche en verre

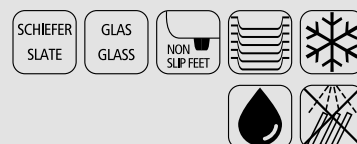

	∅ cm	↑ cm	* mm	€ / set
00984	10,5	8	6 - 9	8,50

**Naturschieferplatten, 4er Set**

natural slate tray, 4 pcs.  
bandeja pizarra natural, set de 4  
plateau ardoise naturelle, set de 4



	cm	* mm	pcs.	€ / set
00997	10 x 10	6 - 9	4	8,50





# SIMPLY WOOD

Eiche, das widerstandsfähigste europäische Holz, ist seit jeher Ausdruck von Qualität, Kraft und Energie. Eichen werden uralt und riesengroß, sind unvergleichlich stark und standfest.

Oak, the most resistant European wood, has always been an expression of quality, strength and energy. Oaks grow to be ancient and huge, are incomparably strong and stable.

El roble, la madera europea más resistente, siempre ha sido expresión de calidad, fuerza y energía. Los robles llegan a ser antiguos y gigantes, son incomparablemente fuertes y estables.

Le chêne, le bois européen le plus résistant, est depuis toujours l'expression de la qualité, de la force et de l'énergie. Les chênes deviennent très vieux et gigantesques, ils sont incomparablement forts et stables.



## Servierbrett „SIMPLY WOOD“

servicing board  
tabla de servir  
planche de service



**Eichenholz geölt, mit Aufhängeloch Ø 1,5 cm, mit Lederband**

oak wood oiled, with handle hole Ø 1,5 cm, with leather strap  
madera de roble aceitada, con agujero para colgar Ø 1,5 cm, con correa de cuero  
bois de chêne huilé, avec trou de suspension Ø 1,5 cm, avec ruban en cuir

	cm	↑ cm	→ Griff / handle	€
00750	20 x 20	2	8	25,00
00751	27 x 17	2	8	29,00
00752	32 x 22	2	8	39,00



mit Lederband  
with leather strap



## Tablett / Sushiboard „SIMPLY WOOD“

tray / sushiboard  
bandeja para sushi  
plateau sushi

aus geöltem Eichenholz  
made of oiled oak wood  
de madera de roble aceitada  
en bois de chêne huilé

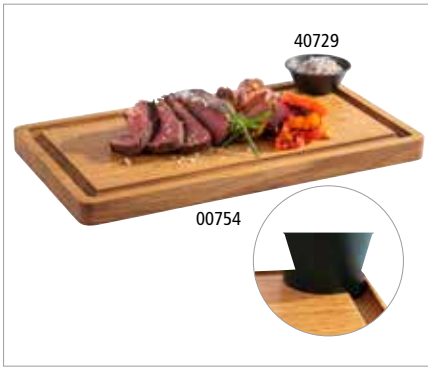

	cm	↑ cm	€
00753	35 x 17	2	22,00

**GN 1/3 Servierbrett „SIMPLY WOOD“**

GN 1/3 serving board  
GN 1/3 tabla de servir  
GN 1/3 planche de service



**Eichenholz geölt, mit Aussparung Ø 4 cm, mit Safrinne**

oak wood oiled, with notch Ø 4 cm, with juice groove  
madera de roble aceitada, con ranura Ø 4 cm, con ranura para líquidos  
bois de chêne huilé, mit avec encoche Ø 4 cm, avec rigole

	cm	↑ cm	GN	€
00754	32,5 x 17,6	2	1/3	22,00

**Servierbrett**

serving board  
tabla de servir  
planche de service



**Eichenholz, geölt, 2 Aussparungen Ø 4,5 cm, 1 Aussparung Ø 3 cm, mit 2 Griffmulden**

oak wood oiled, 2 notches Ø 4,5 cm, 1 notch Ø 3 cm, with 2 recessed handles  
madera de roble aceitada, 2 ranuras Ø 4,5 cm, 1 ranura Ø 3 cm, con 2 asas empotradas  
bois de chêne huilé, 2 encoches Ø 4,5 cm, 1 encoche Ø 3 cm, avec 2 poignées encastrées

	cm	↑ cm	€
00835	15 x 9	1,5	10,00

passende Gläser / fitting glasses / tarros de vidrio adecuados / verrines appropriées

	Ø cm	↑ cm	ltr.	pcs	€ / set
82350	5,5	6	0,075	12	20,40

**Servierbrett „PIZZA“**

serving board  
tabla de servir  
planche de service



**Eichenholz geölt, mit Safrinne, mit 2 Griffmulden**

oak wood oiled, with juice groove, with 2 recessed handles  
madera de roble aceitada, con ranura para líquidos, con 2 asas empotradas  
bois de chêne huilé, avec rigole, avec 2 poignées encastrées

	Ø cm	↑ cm	€
00755	24	2	22,00
00756	29	2	26,00
00757	34	2	30,00

**Serviertablett**

serving tray  
bandeja para servir  
plateau de service



**aus geöltem Eichenholz, mit 2 Griffmulden**

made of oiled oak wood, with 2 recessed handles  
de madera de roble aceitada, con 2 asas empotradas  
en bois de chêne huilé, avec 2 poignées encastrées

	cm	↑ cm	€
00761	45 x 35	6	44,00



# SERVING BOARDS



**Servierbrett**  
 serving board  
 tabla de servir  
 planche de service  
 aus geöltem Akazienholz  
 made of oiled acacia wood  
 de madera de acacia aceitada  
 en bois d'acacia huilé



	cm	↑ cm	€
00793	25 x 17	1,5	13,00



**Servierbrett**  
 serving board  
 tabla de servir  
 planche de service  
 aus geöltem Akazienholz  
 made of oiled acacia wood  
 de madera de acacia aceitada  
 en bois d'acacia huilé



	cm	↑ cm	€
00792	37 x 8	2	10,80



**Präsentationsmöglichkeit**  
 presentation example



**Servierschale**  
 serving bowl  
 cuenca de servir  
 bol de service  
 aus geöltem Akazienholz  
 made of oiled acacia wood  
 de madera de acacia aceitada  
 en bois d'acacia huilé



	cm	↑ cm	€
00790	16,5 x 9	2	10,00
00791	23,5 x 13	2	12,00



### Servierbrett

serving board  
tabla de servir  
planche de service



2-teilig: 1 Holzbrett aus Akazienholz + 1 Naturschieferplatte  
2 pcs.: 1 wood board made of acacia wood + 1 natural slate tray  
set de 2: 1 tabla de madera de acacia + 1 pizarra natural  
set de 2: 1 planche en bois d'acacia + 1 ardoise naturelle

	cm	↑ cm	€/ set
00814	28 x 17,5	2	16,00



### Servierbrett

serving board  
tabla de servir  
planche de service



2-teilig: 1 Holzbrett aus Akazienholz + 1 Naturschieferplatte  
2 pcs.: 1 wood board made of acacia wood + 1 natural slate tray  
set de 2: 1 tabla de madera de acacia + 1 pizarra natural  
set de 2: 1 planche en bois d'acacia + 1 ardoise naturelle

	cm	↑ cm	Griff / handle cm	€/ set
00810	26 x 18	2	8	15,00
00811	33 x 20	2	8	18,40
00812	40 x 15	2	5	23,40
00813	43 x 12	2	12	18,40

### Präsentationsmöglichkeit

presentation example



mit Hängeloch Ø 2 cm / with a handle-hole Ø 2 cm

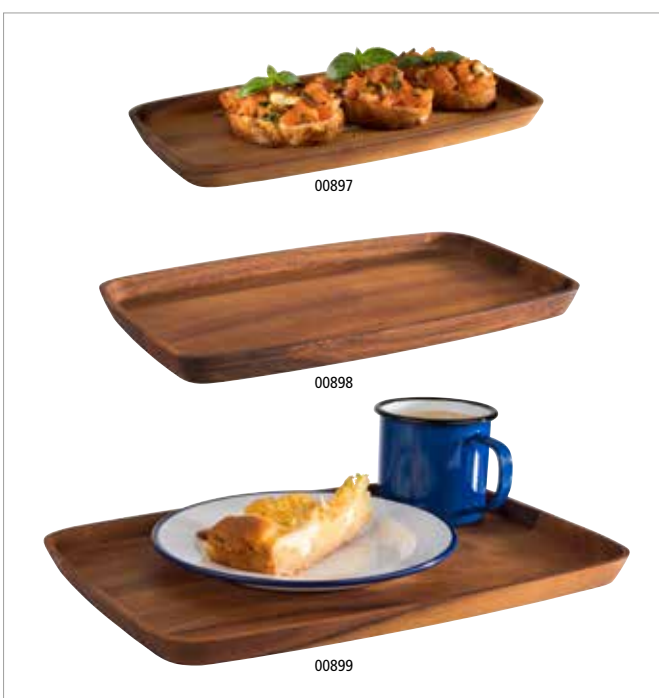

### Servierbrett

serving board  
tabla de servir  
planche de service



Servierbrett aus geöltem Akazienholz  
serving board made of oiled acacia wood  
tabla de servir de madera de acacia aceitada  
planche en bois avec plateau en bois d'acacia huilé

	cm	↑ cm	€
00897	30 x 15	2	13,60
00898	30 x 18	2	16,00
00899	35 x 25	2	22,40

## SERVING BOARDS | WOOD



### Servierbrett „SHARING“

serving board  
tabla de servir  
planche de service



#### Servierbrett aus geöltem Akazienholz

serving board made of oiled acacia wood  
tabla de servir de madera de acacia aceitada  
planche en bois d'acacia huilé

	cm	↑ cm	Griff / handle cm	€
00887	51,5 x 18	1,5	8,5	33,00

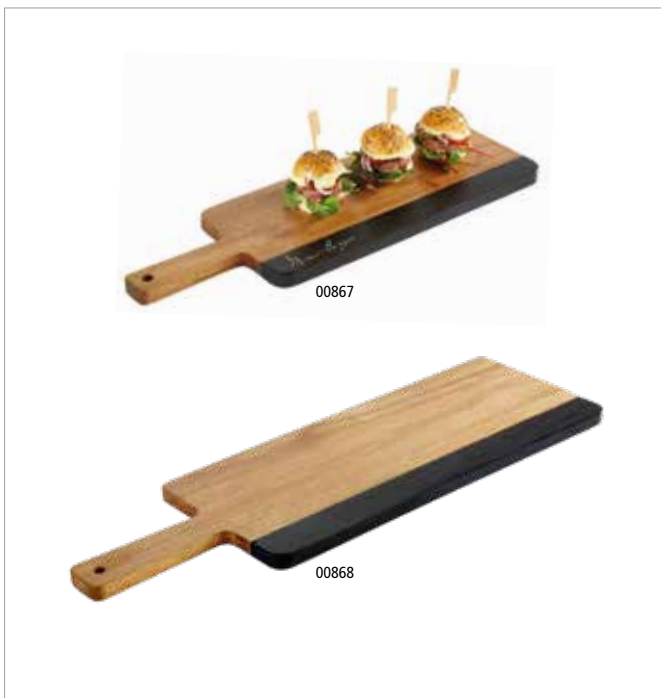

### Servierbrett „AKAZIE-SCHIEFER“

serving board  
tabla de servir  
planche de service



#### geeignet zur Beschriftung, mit Hängeloch Ø 1 cm

suitable for labeling, with hanging hole Ø 1 cm  
apto para rotulación, con orificio para colgar Ø 1 cm  
adapté pour l'étiquetage, avec trou de suspension Ø 1 cm

	cm	↑ cm	Griff / handle cm	€
00867	30,5 x 13	1,5	10	18,00
00868	36,5 x 15	1,5	12	23,00
00869	42,0 x 18	1,5	14	26,00



### Servierbrett „OAK“

serving board  
tabla de servir  
planche de service



#### aus geöltem Eichenholz, Safrille, Ø 9,5 cm Aussparung

made of oiled oak, with juice groove, with hole Ø 9.5 cm  
de madera de roble aceitada, con ranura para líquidos,  
con agujero Ø 9,5 cm

en bois chêne huilé, avec rigole, avec trou Ø 9,5 cm

	cm	↑ cm	€
00808	37 x 25	2	29,00



mit Safrille  
with juice groove



00905



00906

**Servierbrett „OLIVE“**

serving board  
tabla de servir  
planche de service



aus geöltem Olivenholz, naturbedingte Abweichung in Form, Maserung und Größe

oiled olive wood, natural deviation in shape, grain and size  
de madera de olivo aceitada, diferencias naturales posibles en forma, grano y tamaño

en bois d'olivier huilé, éventuelles différences naturelles de forme, de grain et de taille

	cm	↑ cm	€
00905	25,5 x 16,5	1,5	12,00
00906	35,0 x 20,5	1,5	22,00



00870



00873



00875

**Servierbrett „OLIVE“**

serving board  
tabla de servir en madera de olivo  
planche de service en bois d'olivier



aus geöltem Olivenholz, naturbedingte Abweichung in Form, Maserung und Größe, mit Hängeloch Ø 2 cm

oiled olive wood, natural deviation in shape, grain and size, with hanging hole Ø 2 cm

de madera de olivo aceitada, diferencias naturales posibles en forma, grano y tamaño, con orificio para colgar Ø 2 cm

en bois d'olivier huilé, éventuelles différences naturelles de forme, de grain et de taille, avec trou de suspension Ø 2 cm

	cm	↑ cm	Griff / handle cm	€
00870	25 x 17,0	1,5		32,00
00871	30 x 20,5	2,0		52,00
00873	40 x 15,0	1,5	11	56,00
00874	44 x 20,0	2,0	12	72,00
00875	19 x 12,5	1,5	6	23,00
00876	25 x 16,0	1,5	8	35,00
00877	31 x 20,0	1,5	9	52,00

# SERVING BOARD



Ø 6 cm

82316



beidseitig nutzbar  
double-sided usable

## Servierbrett

serving board  
tabla de servir  
planche de service

aus geöltem Eichenholz, mit 8 Aussparungen Ø 6 cm  
made of oiled oak wood, with 8 notches Ø 6 cm  
de madera de roble aceitada con 8 ranuras Ø 6 cm  
en bois de chêne huilé avec 8 encoches Ø 6 cm



	cm	↑ cm	€
00809	100 x 14	1,5	42,00

## Präsentationsmöglichkeit presentation example



40636  
Henkelbecher  
beaker

mit Hängeloch Ø 2 cm / with a handle-hole Ø 2 cm



mit Hängeloch Ø 1,5 cm  
with a handle-hole Ø 1,5 cm



Präsentationsmöglichkeit  
presentation example

## Servierbrett

serving board  
tabla de servir  
planche de service

aus geöltem Buchenholz mit Daumenmulde auf einer Seite  
made of oiled beech wood with thumb recess on one side  
de madera de haya aceitada con hueco para el pulgar en un lado  
en bois de hêtre huilé avec encoche pour le pouce sur un côté



	cm	↑ cm	€
00817	60 x 19,5	2	29,00



**Servierbrett „GENUSSPALETTE“**

serving board  
tabla de servir  
planche de service

**Genusspalette im Kleinformat, Birke**

mini serving palett, birch

tabla de servir, formato pequeño, abedul

planche de service, petit format, bouleau



	cm	↑ cm	€
00880	20 x 12	3	10,00
00881	30 x 20	3	12,00
00882	40 x 15	3	14,80

**Table Caddy „OLIVE“**

table barrel  
caddy de mesa  
caddy de table

**aus geöltem Olivenholz**

oiled olive wood

de madera de olivo aceitada

en bois d'olivier huilé



	cm	↑ cm	€
01016	22 x 15	6	21,00
01017	25 x 18	6	29,00



**Allzweckstreuer, 12 er Set / shaker, 12 pcs. / dosificador, set de 12 / salières/poivrières set de 12**

	cm	↑ cm	ltr.	€ / set
40504	4 x 4	10	0,07	23,40

**passende Brottasche / suitable bread basket / panera a juego / corbeilla assortie**

	cm	↑ cm	Farbe / Colour	€
30356	12 x 11,5	11,5	■	6,80

**passende Mühlen / suitable mills/ molinos de ajuste / moulins assortis**

	ø cm	↑ cm	€
40555	6	15,5	33,20
40556	6	15,5	33,20

**Wachspapier „SNACKHOLDER“**

greaseproof paper squares  
papel alimenticio  
papier alimentaire



	cm	pcs.	Motiv: Zeitung	€ / set
40670	42 x 25	500	Motiv: Zeitung	59,00

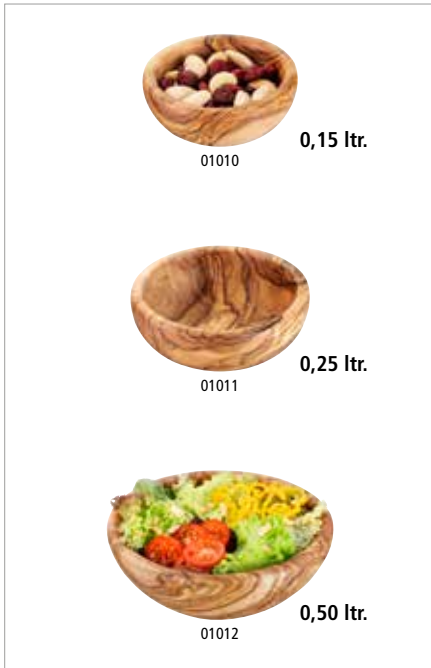

Schale „OLIVE“

bowl  
cuenco  
bol



aus geöltem Olivenholz, naturbedingte Abweichung in Form, Maserung und Größe

oiled olive wood, natural deviation in shape, grain and size

de madera de olivo aceitada, diferencias naturales posibles en forma, grano y tamaño

en bois d'olivier huilé, éventuelles différences naturelles de forme, de grain et de taille

	Ø cm	↑ cm	ltr.	€
01010	10,0	4,0	0,15	10,00
01011	12,5	4,5	0,25	13,80
01012	15,0	6,0	0,50	20,00



3 Größen ineinander  
3 sizes in each other



Schale „OLIVE“

bowl  
cuenco  
bol



aus geöltem Olivenholz, naturbedingte Abweichung in Form, Maserung und Größe

oiled olive wood, natural deviation in shape, grain and size

de madera de olivo aceitada, diferencias naturales posibles en forma, grano y tamaño

en bois d'olivier huilé, éventuelles différences naturelles de forme, de grain et de taille

	cm	↑ cm	ltr.	€
00843	12,0 x 7,5	2,5	0,05	7,80
00844	16,5 x 9,5	2,5	0,10	10,00

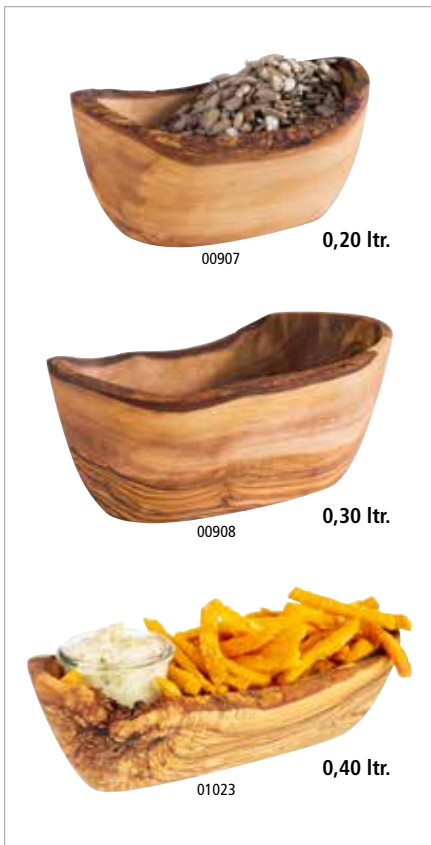

Schale „OLIVE“

bowl  
cuenco  
bol



aus geöltem Olivenholz, naturbedingte Abweichung in Form, Maserung und Größe

oiled olive wood, natural deviation in shape, grain and size

de madera de olivo aceitada, diferencias naturales posibles en forma, grano y tamaño

en bois d'olivier huilé, éventuelles différences naturelles de forme, de grain et de taille

	cm	↑ cm	ltr.	€
00907	13 x 8	6,5	0,2	6,60
00908	16 x 9	7,0	0,3	10,00
01023	25 x 8,5	7,5	0,4	18,00



**Schale „OLIVE“**

bowl  
cuenco  
bol



aus geöltem Olivenholz  
oiled olive wood  
de madera de olivo aceitada  
en bois d'olivier huilé

	cm	↑ cm	litr.	€
01013	7,5 x 7,5	2,5	0,05	5,00
01014	17,5 x 8,5	2,5	0,15	12,40
01015	26,5 x 11,5	5,0	0,60	19,00



Servierbeispiel - Lieferung ohne Gläser  
delivery without glasses

**Holzbox „TABLE“**

woodbox  
caja madera  
base bois



Akazienholz, 3 Fächer (6,5 x 6,5 cm) / acacia wood, 3 compartments (6,5 x 6,5 cm) / madera de acacia, 3 compartimentos (6,5 x 6,5 cm) / bois d'acacia, 3 compartiments (6,5 x 6,5 cm)

	cm	↑ cm	inner size cm	€
11727	23,5 x 8,5	4,5	6,5 x 6,5 je Fach / each compartment	12,90



Servierbeispiel - Lieferung ohne Gläser  
delivery without glasses

**Servierbrett „NARROW I“**

serving board  
tabla de servir  
planche de service



Akazienholz, mit 3 Vertiefungen Ø 4 cm / acacia wood, with 3 notches Ø 4 cm  
madera de acacia, con 3 ranuras Ø 4 cm / bois d'acacia, avec 3 encoches Ø 4 cm

	cm	↑ cm	€
00864	22 x 8	1,5	9,90

passende Schälchen / fitting bowls / cuencos adecuados / bols appropriés

	Ø cm	↑ cm	litr.		€
82359	5	3,5	0,035	glass / 12 pcs	11,30
82350	6	5,5	0,08	glass / 12 pcs	20,40
40685	6	3,0	0,05	stainless steel	2,40



Servierbeispiel - Lieferung ohne Schälchen  
delivery without bowls

**Servierbrett „NARROW II“**

serving board  
tabla de servir  
planche de service



Akazienholz, mit 3 Vertiefungen Ø 6 cm  
acacia wood, with 3 notches Ø 6 cm  
madera de acacia, con 3 ranuras Ø 6 cm  
bois d'acacia, avec 3 encoches Ø 6 cm

	cm	↑ cm	€
00878	31 x 11	2	11,20

passende Schälchen / fitting bowls / cuencos adecuados / bols appropriés

	Ø cm	↑ cm	litr.		€
40686	8	4,5	0,17	stainless steel	3,60





# Buffet & Tableware Melamine





CRAZY WOOD.....	174	ZERO   DRIFTWOOD.....	217
NERO.....	176	SLATE.....	218
LOOPS.....	180	SLATE ROCK.....	220
CANCUN.....	182	OAK.....	221
MOON.....	183	MARONE.....	222
EMMA.....	184	GLAMOUR.....	225
STONE ART.....	186	ASIA+.....	226
BAMBOO.....	189	APS+.....	229
BLUE OCEAN.....	190	HALFTONE.....	230
ARABESQUE.....	192	PURE.....	232
FOOTMARK.....	194	FLOAT.....	236
AIKO.....	195	SINUS   APART   CASCADE...238	
ELEMENT.....	196	GLOBAL BUFFET.....	239
DARK WAVE.....	198	BALANCE.....	241
MEDITERRANEAN.....	200	CASUAL.....	242
LA VIDA.....	200	MINI.....	244
ENAMEL LOOK.....	201	FLYING BUFFET.....	247
CROCKER.....	202	PARTY SPOON.....	248
ZEN.....	204	CUTLERY REST.....	250
FRIDA.....	208	GN CONTAINERS.....	251
OAK LIGHT.....	216		

**NEW** CRAZY WOOD



**GN Tablett „CRAZY WOOD“**  
GN tray  
GN bandeja  
GN plateau

**original** APS melamine **MAX 70°C**   

	cm	↑ cm	GN	€
85300	32,5 x 26,5	1	1/2	26,00
85301	32,5 x 17,6	1	1/3	20,00
85302	53 x 16,2	1	2/4	27,00

 85300

**Präsentationsmöglichkeit**  
presentation example



**Farbstreifen in Orange**  
orange color stripes



**Tablett „CRAZY WOOD“**  
tray  
bandeja  
plateau

**original** APS melamine **MAX 70°C**  

**Servierfläche: 34 x 17,5 cm, Gesamtlänge: 45 cm, mit Hängeloch: Ø 0,8 cm**  
serving area: 34 x 17,5 cm, total length: 45 cm, handle hole: Ø 0,8 cm  
superficie servicio: 34 x 17,5 cm, longitud total: 45 cm, con agujero para colgar: Ø 0,8cm  
surface de service: 34 x 17,5 cm, longueur totale: 45 cm, avec trou de suspension: Ø 0,8cm

	cm	↑ cm	Griff / handle cm	€
85303	45 x 17,5	1,5	11	30,00



**Tablett „CRAZY WOOD“**  
tray  
bandeja  
plateau

**original** APS melamine **MAX 70°C**  

**Servierfläche: 40 x 20 cm, Grifflänge: 13 cm, Gesamtlänge: 53 cm, mit Hängeloch: Ø 0,8 cm**  
serving area: 40 x 20 cm, total length: 53 cm, handle hole: Ø 0,8 cm  
superficie de servicio: 40 x 20 cm, longitud total: 53 cm, con agujero para colgar: Ø 0,8cm  
surface de service: 40 x 20 cm, longueur totale: 53 cm, avec trou de suspension: Ø 0,8cm

	Ø cm	↑ cm	Griff / handle cm	€
85304	53 x 20	1,5	13	36,00

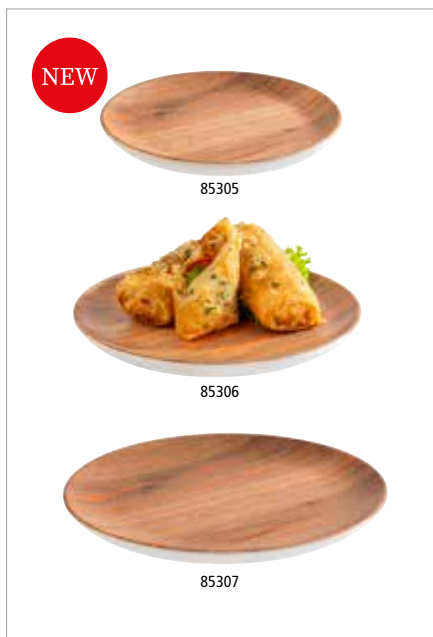

Teller „CRAZY WOOD“

plate  
plato  
assiette



	Ø cm	↑ cm	€
85305	15	1,5	8,00
85306	20	1,5	12,00
85307	26	2	18,00

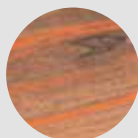

Farbstreifen in Orange  
orange color stripes

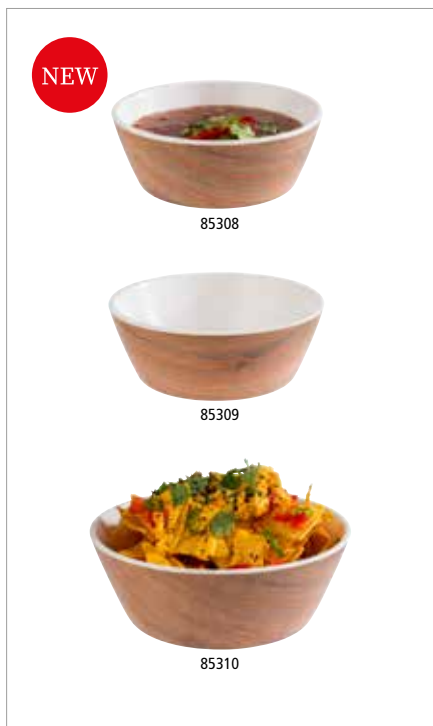

Schale „CRAZY WOOD“

bowl  
cuenco  
bol



	Ø cm	↑ cm	ltr.	€
85308	12,5	4,5	0,25	10,40
85309	12,5	5,5	0,5	17,40
85310	20,5	7,5	1,2	25,00

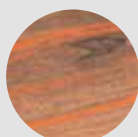

Farbstreifen in Orange  
orange color stripes

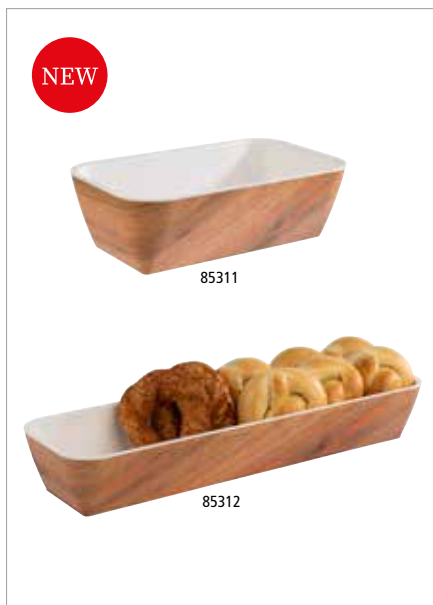

GN Schale „CRAZY WOOD“

GN bowl  
GN cuenco  
GN bol



	cm	↑ cm	ltr.	GN	€
85311	26,5 x 16,2	8	1,8	1/4	23,00
85312	53 x 16,2	8	4,0	2/4	31,00

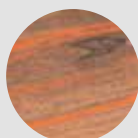

Farbstreifen in Orange  
orange color stripes



# NERO



## GN Tablett „NERO“

GN tray  
GN bandeja  
GN plateau



	cm	↑ cm	GN	€
85067	53,0 x 32,5	2,5	1/1	37,50
85068	32,5 x 26,5	2,5	1/2	20,00
85275 <span style="color:red">NEW</span>	53,0 x 16,2	2,5	2/4	21,00

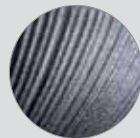

## Teller „NERO“

plate  
plato  
assiette



	Ø cm	↑ cm	€
85073	15	3	6,00
85063	21	3	8,20
85064	26	3	9,20
85065	33	3,5	14,20
85066	42	3,5	26,00

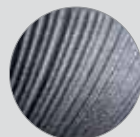





Teller „NERO“

plate  
plato  
assiette



	∅ cm	↑ cm	ltr.	€
85098	29	6	0,3	16,80



Schale „NERO“

bowl  
cuenco  
bol



	∅ cm	↑ cm	ltr.	€
85069	16	6,5	0,5	7,20
85070	19	8,0	0,9	10,80
85061	24	9,0	1,7	16,40

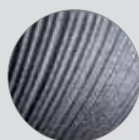

Schale „NERO“

bowl  
cuenco  
bol



	∅ cm	↑ cm	ltr.	€
85060	22,5	4,5	0,8	11,80
85062	30,0	7,0	2,2	22,00

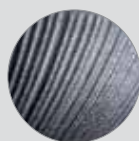

Schale „NERO“

bowl, square  
cuenco, cuadrado  
bol creux carré



	cm	↑ cm	ltr.	€
85274 <small>NEW</small>	16,5 x 16,5	5,5	0,6	9,00
85071	19,5 x 19,5	8	1,5	14,20
85072	25,0 x 25,0	11	3,5	23,40

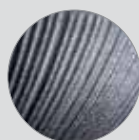



**Teller „NERO“**  
 plate  
 plato  
 assiette

mit integriertem Dipschälchen / Vertiefung  
 with integrated dip bowl / with notch  
 con cuenco para dip integrado / con ranura  
 avec ramequin intégré / avec encoche

original  
 APS  
 melamine

MAX  
 70°C

	cm	↑ cm	ltr.	€
85074	24 x 20	2,5	0,04	9,40
85075	30 x 25	2,5	0,06	12,40



**Tablett „NERO“**  
 tray  
 bandeja  
 plateau

mit 2 integrierten Dipschälchen / Vertiefungen  
 with 2 integrated dip bowls / with 2 notches  
 con 2 cuencos para dip integrados / con 2 ranuras  
 avec 2 ramequins intégrés / avec 2 encoches

original  
 APS  
 melamine

MAX  
 70°C

	cm	↑ cm	ltr.	€
85097	41 x 15	2,5	2 x 0,03	18,80



**Schale „NERO“**  
 bowl  
 cuenco  
 bol

original  
 APS  
 melamine

MAX  
 70°C

	cm	↑ cm	ltr.	€
85076	23 x 18	5	0,6	12,40
85077	28 x 22	7	0,8	18,80



**Schale „NERO“**  
 bowl  
 cuenco  
 bol

original  
 APS  
 melamine

MAX  
 70°C

	cm	↑ cm	ltr.	€
85092	14,5 x 12,5	8	0,3	7,00
85093	19,0 x 16,5	9	0,5	9,40



Schale „NERO“

bowl  
cuenco  
bol



	∅ cm	↑ cm	ltr.	€
85270	8,5	3,5	0,1	3,50



Schale „NERO“

bowl  
cuenco  
bol



	∅ cm	↑ cm	ltr.	€
85271	12,5	4,5	0,25	7,80
85272	15,5	5,5	0,45	8,80
85273	20,5	7,5	1,2	13,00

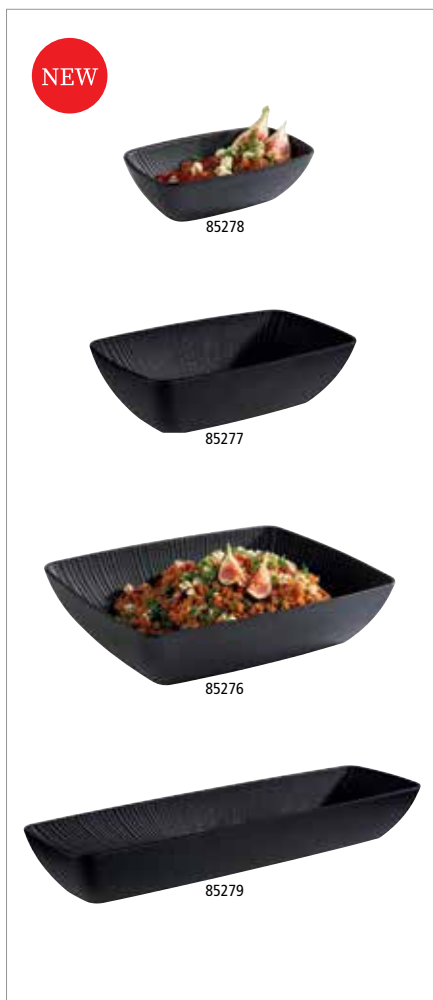
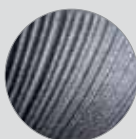

GN Schale „NERO“

GN bowl  
GN cuenco  
GN bol



	cm	↑ cm	ltr.	GN	€
85278	17,6 x 10,8	5,5	0,35	1/9	8,80
85277	26,5 x 16,2	7,5	1,5	1/4	18,00
85276	32,5 x 26,5	7,5	3,5	1/2	24,00
85279	53 x 16,2	7,5	3,5	2/4	27,00

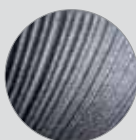



# LOOPS

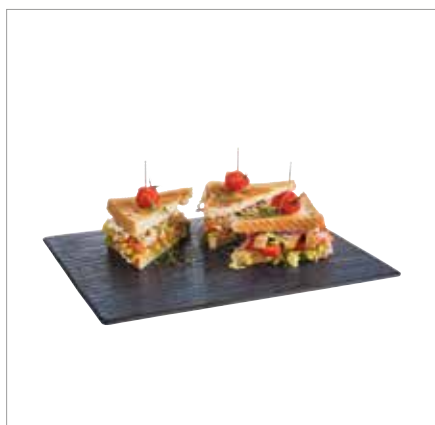

## GN Tablett „LOOPS“

GN tray  
GN bandeja  
GN plateau



	cm	↑ cm	GN	€
85021	32,5 x 26,5	1,5	1/2	25,20



mit Antirutschfüßchen  
with non-slip feet



## Tablett/Sushiboard „LOOPS“

tray  
bandeja  
plateau



	cm	↑ cm	€
85025	23,5 x 13,5	1,5	8,80



85027

## Teller „LOOPS“

plate  
plato  
assiette



	Ø cm	↑ cm	€
85027	22	2	9,00
85028	27	2	14,50



## Teller „LOOPS“

plate  
plato  
plateau



	Ø cm	↑ cm	€
85024	34 x 15,5	4	19,60



## Schale „LOOPS“

bowl  
cuenco  
bol



	Ø cm	↑ cm	ltr.	€
85026	18	3	0,25	7,60



Schale „LOOPS“

bowl  
cuenco  
bol



	Ø cm	↑ cm	ltr.	€
85029	20,5	6,5	1,0	16,70
85030	31,0	8,0	2,0	36,20



Schale „LOOPS“

bowl  
cuenco  
bol



	Ø cm	↑ cm	ltr.	€
85036	15,0	7,0	0,5	8,00
85037	18,5	8,0	1,0	14,80
85038	24,0	9,0	1,8	22,00



Teller „LOOPS“

plate  
plato  
assiette



	cm	↑ cm	€
85055	28 x 13,5	4,0	14,00



Teller „LOOPS“

plate  
plato  
assiette



	Ø cm	↑ cm	€
85056	23	3,5	15,00



Teller „LOOPS“

plate  
plato  
assiette



	Ø cm	↑ cm	€
85057	25,5	4,5	15,00



**Tablett/Sushiboard „CANCUN“**  
tray/sushiboard  
bandeja para sushi  
plateau sushi



	cm	↑ cm	€
85200	23,5 x 13,5	1,5	8,80



**Teller „CANCUN“**  
plate  
plato  
assiette



	cm	↑ cm	€
85201	28 x 13,5	4,0	14,00



**Schale „CANCUN“**  
bowl  
cuenco  
bol



	Ø cm	↑ cm	ltr.	€
85205	15,0	7,0	0,5	8,00
85206	18,5	8,0	1,0	14,80
85207	20,5	6,5	1,0	16,70
85208	24,0	9,0	1,8	22,00



**Teller „CANCUN“**  
plate  
plato  
assiette



	Ø cm	↑ cm	€
85202	18,0	3,0	7,60
85203	23,0	3,5	15,00



**Teller „CANCUN“**  
plate  
plato  
assiette



	Ø cm	↑ cm	€
85204	25,5	4,5	15,00

## MOON

6 tlg.  
6 pcs.

85080



85081

## Servierset „MOON“, 6-teilig

serving set, 6 pcs.

set para servir, set de 6

set de service, set de 6

6-teiliges Set: 3 Schalen + 3 Holzlöffel (Nanmu)

6 pcs.: 3 bowls + 3 wooden spoons (Nanmu)

set de 6: 3 cuencos + 3 cucharas de madera (Nanmu)

set de 6: 3 bols + 3 cuillères en bois (Nanmu)



	Ø cm	↑ cm	ltr.	Farbe / Colour	€/ set
85080	8	7,5	0,05		34,00
85081	8	7,5	0,05		34,00

2 tlg.  
2 pcs.

85082



85083

## Servierset „MOON“, 2-teilig

serving set, 2 pcs.

set para servir, set de 2

set de service, set de 2

2-teiliges Set: 1 Schale + 1 klappbarer Deckel

2 pcs.: 1 bowl + 1 hinged cover

set de 2: 1 cuenco + 1 tapa con bisagra

set de 2: 1 bol + 1 couvercle avec charnières



	Ø cm	↑ cm	ltr.	Farbe / Colour	€/ set
85082	19	17,5	0,8		39,50
85083	19	17,5	0,8		39,50



85083



85082

klappbarer Deckel  
hinged coverPräsentationsmöglichkeit  
presentation example

# EMMA



85113

85116

85105

85104

85120

85101



85101 0,06 ltr



85104 0,50 ltr



85111 2,3 ltr

## Schale „EMMA“ bowl cuenco bol



MAX  
70°C



	Ø cm	↑ cm	ltr.	Farbe / Colour	€
85100	7,5	3,5	0,06		5,50
85101	7,5	3,5	0,06		5,50
85103	7,5	3,5	0,06		5,50
85104	14	6,5	0,5		9,90
85105	14	6,5	0,5		9,90
85107	14	6,5	0,5		9,90
85108	23	10,5	2,3		22,00
85109	23	10,5	2,3		22,00
85111	23	10,5	2,3		22,00

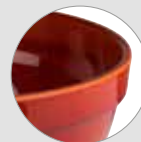
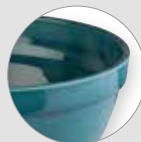



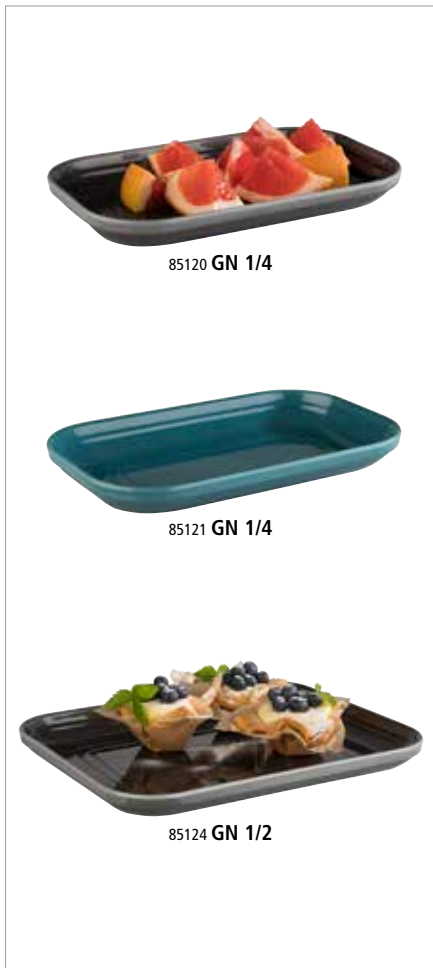

GN Tablett „EMMA“

GN tray  
GN bandeja  
GN plateau



	cm	↑ cm	GN	Farbe / Colour	€
85120	26,5 x 16,2	3	1/4		15,40
85121	26,5 x 16,2	3	1/4		15,40
85124	32,5 x 26,5	3	1/2		24,20
85125	32,5 x 26,5	3	1/2		24,20

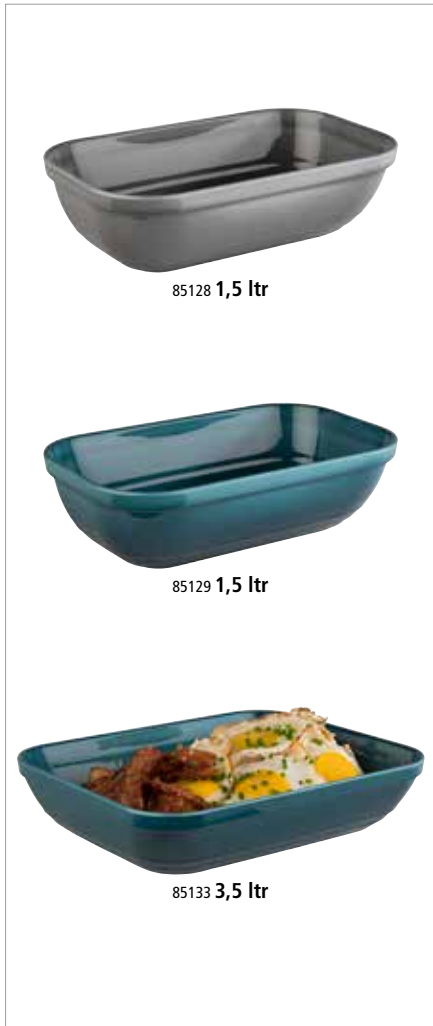
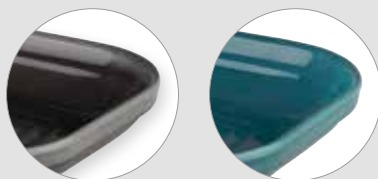

GN Schale „EMMA“

GN bowl  
GN cuenco  
GN bol



	cm	↑ cm	ltr.	GN	Farbe / Colour	€
85128	26,5 x 16,2	7,5	1,5	1/4		20,90
85129	26,5 x 16,2	7,5	1,5	1/4		20,90
85132	32,5 x 26,5	7,5	3,5	1/2		28,60
85133	32,5 x 26,5	7,5	3,5	1/2		28,60



Cooling bowl





84511

**Teller „STONE ART“**  
plate  
plato  
assiette



	Ø cm	↑ cm		€
84510	19	2		8,30
84511	25	2		12,90
84512	30	2		18,40



84509

**Teller „STONE ART“**  
plate  
plato  
assiette



	Ø cm	↑ cm	ltr.	€
84509	15,5	2,5	0,15	6,30
84514	20,0	4,5	0,60	11,40



**Teller „STONE ART“**  
plate  
plato  
assiette



	Ø cm	↑ cm		€
84515	24,5	3,5		14,30



**Teller „STONE ART“**  
plate  
plato  
assiette



	cm	↑ cm		€
84517	33 x 32,5	3		26,30



Schale „STONE ART“

bowl  
cuenco  
bol



	∅ cm	↑ cm	ltr.	VE / unit	€ / pc.
84523	8	3	0,07	12	2,90



Schale „STONE ART“

bowl  
cuenco  
bol



	∅ cm	↑ cm	ltr.	€
84524	12	6	0,3	5,60



Schale „STONE ART“

bowl  
cuenco  
bol



	∅ cm	↑ cm	ltr.	€
84525	15	7,5	0,6	6,90



Schale „STONE ART“

bowl  
cuenco  
bol



	cm	↑ cm	ltr.	€
84526	23 x 19	6,5	0,6	12,50



Schale „STONE ART“

bowl  
cuenco  
bol



	cm	↑ cm	ltr.	€
84528	28,5 x 21	7,5	1,2	20,70



84529

Schale „STONE ART“

bowl  
cuenco  
bol



	cm	↑ cm	ltr.	€
84529	19 x 19	6,0	0,5	13,60
84530	24 x 24	6,5	1,1	18,90

## STONE ART



### GN Tablett „STONE ART“

GN tray  
GN bandeja  
GN plateau



	cm	↑ cm	GN	€
84519	53,0 x 32,5	1,5	1/1	49,40
84520	32,5 x 26,5	1,5	1/2	27,10
84522	53,0 x 16,2	1,5	2/4	28,20
84521	32,5 x 17,6	1,5	1/3	19,90



mit Antirutschfüßchen  
with non-slip feet



### GN Abdeckhaube

GN cover  
GN cubierta  
GN cloche



passend für GN Tablett, glasklarer Kunststoff, nahezu unzerbrechlich

suitable for GN trays, clear plastic, nearly unbreakable

apto para bandejas GN, plástico transparente, muy resistente a la rotura

pour plateaux GN, plastique transparent, très résistant à la casse

	cm	↑ cm	✱ mm	GN	€
11043	32,5 x 17,6	10,5	3	1/3	17,00
11044	53,0 x 16,2	10,5	3	2/4	23,00

	cm	↑ cm	✱ mm	GN	€
11041	32,5 x 26,5	9,5	3	1/2	23,00
11042	53,0 x 32,5	9,5	3	1/1	32,00

# BAMBOO



## Schale „BAMBOO“

bowl  
cuenco  
bol



	cm	↑ cm	ltr.	€
84815	10,5 x 10,0	3,0	0,03	3,00
84816	17,5 x 15,5	5,5	0,2	7,90



## Schale „BAMBOO“

bowl  
cuenco  
bol



	Ø cm	↑ cm	ltr.	€
84819	30,5	8,5	2	22,40

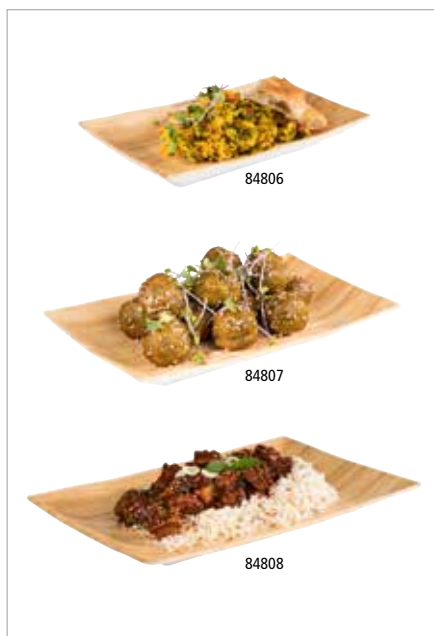

## Tablett „BAMBOO“

tray  
bandeja  
plateau



	cm	↑ cm	€
84806	21,0 x 13,0	3,0	6,20
84807	24,5 x 15,5	3,0	9,70
84808	34,5 x 21,5	3,0	19,50

# BLUE OCEAN



Da geht die Sonne auf!  
Maritime Aquatöne, Farbverläufe und klassisches Blau-Weiß erinnern an eine griechische Taverne in der Ägäis.

The sun is rising!  
Maritime aqua tones, gradients and classic blue and white reminiscent of a Greek tavern in the Aegean Sea.

¡Está saliendo el sol!  
Los tonos marinos, los degradados de color, el clásico azul y blanco recuerdan a una taberna griega en el mar Egeo.

Le soleil se lève!  
Les tons maritimes, les dégradés de couleurs, le bleu et le blanc classiques, tout rappellent une taverne grecque de la mer Égée.

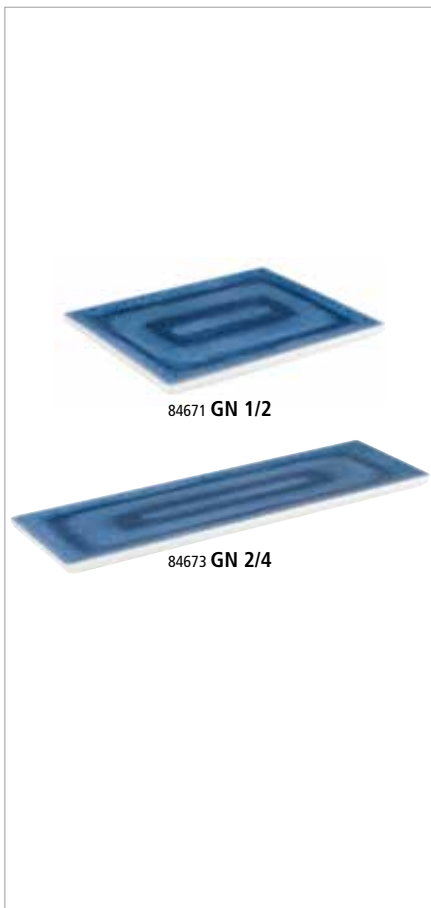

## GN Tablett „BLUE OCEAN“

GN tray  
GN bandeja  
GN plateau



	cm	↑ cm	GN	€
84671	32,5 x 26,5	2	1/2	27,60
84672	32,5 x 17,6	2	1/3	20,50
84673	53,0 x 16,2	2	2/4	28,80

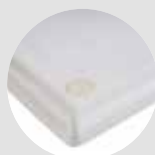

mit Antirutschfüßchen  
with non-slip feet



Tablett „BLUE OCEAN“

tray  
bandeja  
plateau



	cm	↑ cm	€
84676	48 x 35,5	3	27,60



84677 0,6 ltr

84678 3,0 ltr

Schale „BLUE OCEAN“

bowl  
cuenco  
bol

	Ø cm	↑ cm	ltr.	€
84677	15	7,5	0,6	8,00
84678	30,5	9	3	20,70



84674

84675

Teller „BLUE OCEAN“

plate  
plato  
assiette



	Ø cm	↑ cm	€
84674	21,5	2	10,60
84675	26,5	2	14,30



84678



84677



84678

# ARABESQUE



Beim Anblick der mediterranen Melamin Serie ARABESQUE bekommt man direkt Lust auf eine Tapas-Party. Mit seinem spanischen Charme und den wundervoll ausgearbeiteten Details holen Sie sich ein Stück Spanien auf Ihr Buffet.

When looking at the Mediterranean melamine series ARABESQUE, the longing for a tapas party resurfaces. With its Spanish charm and the beautifully crafted details, you get a slice of Spain on your buffet.

Al ver la serie mediterránea de melamina ARABESQUE, se obtiene un dicho antojo por una fiesta de tapas. Con su encanto español y los detalles bellamente elaborados, obtendrá un trozo de España en su buffet.

En regardant la série de mélamine méditerranéenne ARABESQUE, vous obtenez envie de préparer une fête de tapas. Avec son charme espagnol et les détails joliment ouvres, vous aurez une tranche d'Espagne sur votre buffet.



84680 GN 1/1

84682 GN 1/3

84683 GN 2/4

## GN Tablett „ARABESQUE“

GN tray  
GN bandeja  
GN plateau



	cm	↑ cm	GN	€
84680	53,0 x 32,5	2	1/1	50,60
84681	32,5 x 26,5	2	1/2	27,60
84682	32,5 x 17,6	2	1/3	20,70
84683	53,0 x 16,2	2	2/4	28,80

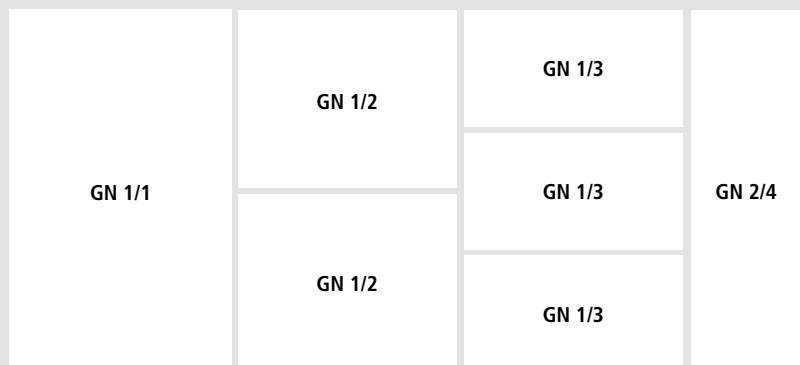





84687



84688



84689



84690

## Schale „ARABESQUE“

bowl  
cuenco  
bol

	Ø cm	↑ cm	litr.	€
84687	10,0	6,0	0,2	5,30
84688	15,5	8,0	0,8	8,00

	Ø cm	↑ cm	litr.	€
84689	20,5	5,5	1,1	11,80
84690	31,0	9,0	3,0	24,20



## Teller „ARABESQUE“

plate  
plato  
assiette

	cm	↑ cm	€
84686	38 x 15,5	2	16,10



84684



84685

## Teller „ARABESQUE“

plate  
plato  
assiette

	Ø cm	↑ cm	€
84684	21,5	2	10,30
84685	26,5	2	14,30

NEW

FOOTMARK



NEW



85321

Schale „FOOTMARK“

bowl  
cuenco  
bol



	Ø cm	↑ cm	ltr.	€
85320	13	5,5	0,25	6,90
85321	18	5,5	0,6	10,00

NEW



Teller, tief „FOOTMARK“

plate, deep  
plato hondo  
assiette creuse



	Ø cm	↑ cm	ltr.	€
85322	24	4	0,8	13,00

NEW



85324

Teller „FOOTMARK“

plate  
plato  
assiette



	Ø cm	↑ cm	€
85323	21	2	9,60
85324	26,5	2,5	12,80

## AIKO



Schalen der Serie Aiko eignen sich perfekt zum Präsentieren von leckeren Saucen, Pasten oder frischem Sushi. Aber auch kleines Fingerfood kann hübsch präsentiert und angerichtet werden.

Bowls from the Aiko series are perfect for presenting delicious sauces, pastes or fresh sushi. Also small finger food can be presented and served in a pretty way.

Los cuencos de la serie Aiko son perfectos para presentar deliciosas salsas, pastas o sushi fresco. Pero también se pueden presentar y servir de forma atractiva pequeños aperitivos.

Les bols de la série Aiko sont parfaits pour présenter de délicieuses sauces, des pâtes ou des sushis frais. Mais les petits apéritifs peuvent également être présentés et servis de manière attrayante.



## Schale „AIKO“

bowl  
cuenco  
bol

Steinoptik

appearance stoneware  
su aspecto recuerda al gres  
l'aspect de la mélamine rapelle le grès



	Ø cm	↑ cm	ltr.	Farbe / Colour	€
84329	8,0	4	0,07	■	3,80
84331	11,5	6	0,20	■	5,10



## Schale „AIKO“

bowl  
cuenco  
bol

Steinoptik

appearance stoneware  
su aspecto recuerda al gres  
l'aspect de la mélamine rapelle le grès



	Ø cm	↑ cm	ltr.	Farbe / Colour	€
84335	16,0	7	0,6	■	8,30
84337	20,5	8	1,2	■	12,70

# ELEMENT



Betonoberflächen auf dem Buffet für den Kontakt mit Lebensmitteln?  
**ELEMENT** macht es möglich.  
 Bestens geeignet im modernen und urbanen Ausstattungsumfeld.

Concrete surfaces on the buffet for food contact?  
**ELEMENT** makes it possible.  
 Ideally suited for modern and urban environments.

¿Superficies de hormigón en el buffet y tener contacto con alimentos?  
**ELEMENT** lo hace possible.  
 Ideal para ambientes modernos y urbanos.

Des surfaces en béton sur le buffet et destinées au contact alimentaire?  
**ELEMENT** le rend possible.  
 Idéal pour les environnements modernes et urbains.



## Schale „ELEMENT“

bowl  
 cuenco  
 bol



	cm	↑ cm	ltr.	VE / unit	€ / pc.
84825	∅ 8,0	2,0	0,01	24	1,80
84826	10,5 x 10,0	3,0	0,02	24	3,40
84820	9,0 x 7,0	3,0	0,03	24	3,40
84821	10,5 x 10,5	3,0	0,04	12	3,80
84827	17,5 x 15,5	5,5	0,18		7,90



## Schale „ELEMENT“

bowl  
 cuenco  
 bol



	∅ cm	↑ cm	ltr.	€
84828	16	7	0,5	9,20
84829	28	12	3,0	26,70



82831 3,0 ltr

Schale „ELEMENT“

bowl  
cuenco  
bol



	cm	↑ cm	ltr.	€
84830	19 x 19	9	1,5	26,70
84831	25 x 25	12	3,8	40,30



Tablett „ELEMENT“

tray  
bandeja  
plateau



	cm	↑ cm	€
84824	31 x 10,5	1,5	10,20



GN Tablett „ELEMENT“

GN tray  
GN bandeja  
GN plateau



	cm	↑ cm	GN	€
84400	53,0 x 32,5	3,5	1/1	44,00
84401	32,5 x 26,5	3,5	1/2	24,20
84402	32,5 x 17,5	3,5	1/3	17,80
84403	26,5 x 16,2	3,5	1/4	13,80
84404	53,0 x 16,2	3,5	2/4	26,70



Schale „ELEMENT LOOK“

bowl  
cuenco  
bol



	Ø cm	↑ cm	ltr.	€
84835	21,5	5,5 / 9,5	0,7	27,40
84836	26,0	7,0 / 12,5	1,45	33,00
84837	30,0	8,5 / 14,5	2,3	47,00



1,45 ltr.

84836



mit Antirutschfüßchen  
with non-slip feet



# DARK WAVE



## GN Tablett „DARK WAVE“

GN tray  
GN bandeja  
GN plateau



	cm	↑ cm	GN	€
84900	53,0 x 32,5	2	1/1	46,50
84901	32,5 x 26,5	2	1/2	23,70
84902	32,5 x 17,6	2	1/3	14,30
84903	53,0 x 16,2	2	2/4	22,80



mit Antirutschfüßchen  
with non-slip feet



Tablett „DARK WAVE“

tray  
bandeja  
plateau



	cm	↑ cm	€
84904	14 x 14	2	5,30



Tablett „DARK WAVE“

tray  
bandeja  
plateau



	cm	↑ cm	€
84905	23 x 10,5	1,5	7,40
84906	29 x 12,0	1,5	9,70



Teller „DARK WAVE“

plate  
plato  
assiette



	Ø cm	↑ cm	€
84907	14,5	1,5	4,00
84908	22,0	2,0	8,00
84909	27,0	2,5	12,00



Schale „DARK WAVE“

bowl  
cuenco  
bol



	Ø cm	↑ cm	litr.	€
84910	17,5	5,0	0,50	9,00
84911	22,5	5,0	0,75	11,80
84912	32,0	3,5	–	19,40

NEW

# MEDITERRANEAN



NEW

## Schale / Teller „MEDITERRANEAN“

bowl / plate  
cuenco / plato  
bol / assiette



	cm	↑ cm	ltr.	€
85290	18,5 x 11,5	3	0,2	10,00



Präsentationsmöglichkeit  
presentation example

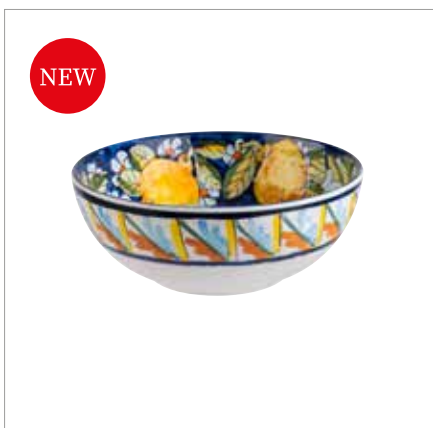

NEW

## Schale „MEDITERRANEAN“

bowl  
cuenco  
bol



	Ø cm	↑ cm	ltr.	€
85291	20,5	8	1,2	25,00



Präsentationsmöglichkeit  
presentation example

# LA VIDA

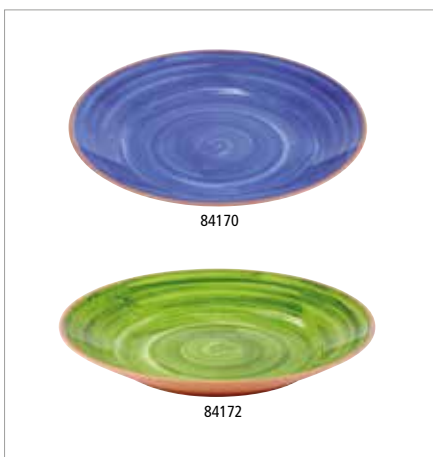

84170

84172

## Tablett „LA VIDA“

plate / tray  
plato / bandeja  
assiette / plateau



	Ø cm	↑ cm	Farbe / Colour	€
84161	32,0	3,5		33,40
84170	40,5	5,5		48,30
	Ø cm	↑ cm	Farbe / Colour	€
84171	32,0	3,5		33,40
84172	40,5	5,5		48,30



# ENAMEL LOOK



84951 Ø 24,5 cm



84958



84494

84490

84492



84950

84951

## Teller „ENAMEL LOOK“

plate  
plato  
assiette



	Ø cm	↑ cm	Farbe / Colour	€
84950	20,5	2,0		6,30
84951	24,5	2,5		8,30



84958

84959

## Schale „ENAMEL LOOK“

bowl  
cuenco  
bol



	cm	↑ cm	ltr.	Farbe / Colour	€
84958	15,0 x 11,5	6,5	0,30		3,70
84959	21,5 x 16,5	9,5	1,00		8,30



84490

84492

## Schale „ENAMEL LOOK“

bowl  
cuenco  
bol



	Ø cm	↑ cm	ltr.	Farbe / Colour	€
84490	5,5	4,0	0,02		2,20
84491	9,5	4,5	0,09		3,70
84492	13,0	6,5	0,30		8,00

# CROCKER



Servier- und Buffetartikel in Tonoptik, brauner Rand. Die Oberfläche ist innen und außen fein-matt, fühlt sich an wie Ton.

Serving and buffet items, an imitation of clay, with a brown border. The surface is inside and outside fine-matt. Feels like real clay.

Artículos de servicio y buffet, imitación barro y con borde marrón. La superficie de dentro y de fuera es de deslustre fino. Parece barro natural.

Pièces de service et pour le buffet imitation argile avec bord marron. La surface est à l'intérieur et à l'extérieur bien-matte.



Teller „CROCKER“  
plate  
plato  
assiette



	cm	↑ cm	Farbe / Colour	€
84567	14 x 13	2,5		3,90
84568	14 x 13	2,5		3,90



Teller „CROCKER“  
plate  
plato  
assiette



	Ø cm	↑ cm	ltr.	Farbe / Colour	€
84575	20,5	3	0,50		7,40
84576	20,5	3	0,50		7,40



Schale „CROCKER“  
bowl  
cuenco  
bol



	Ø cm	↑ cm	ltr.	Farbe / Colour	€
84573	16,5	4	0,50		6,80
84574	16,5	4	0,50		6,80



Schale „CROCKER“  
bowl  
cuenco  
bol



	Ø cm	↑ cm	ltr.	Farbe / Colour	€
84569	12,5	6	0,37		4,20
84570	12,5	6	0,37		4,20
84571	16,0	7	0,70		7,00
84572	16,0	7	0,70		7,20
84577	21,0	8	1,45		12,00
84578	21,0	8	1,45		12,00



Blattschale „CROCKER“  
leaf  
fuente en forma de hoja  
plateau feuille



	cm	↑ cm	ltr.	Farbe / Colour	€
84579	30,5 x 10	7,5	0,17		7,90
84580	30,5 x 10	7,5	0,17		7,90
84581	42 x 14	9,5	0,65		18,40
84582	42 x 14	9,5	0,65		18,40

## ZEN



Fernöstliche Tisch- und Buffetartikel präsentiert die Serie ZEN. Die Optik entspricht dem japanischen Steingut.

The ZEN series presents Far Eastern table and buffet articles. The appearance is that of Japanese stoneware.

La colección ZEN presenta artículos de buffet y mesa para la cocina oriental. Su aspecto recuerda al gres japonés.

La collection ZEN présente des articles de buffet et de table pour la cuisine orientale. L'aspect de la mélamine rappelle le grès japonais.



## Schale „ZEN“

bowl  
cuenco  
bol



	Ø cm	↑ cm	ltr	Farbe / Colour	€
83929	31	8,5	2,5	■	27,10



## Schale „ZEN“

bowl  
cuenco  
bol



	Ø cm	↑ cm	ltr	Farbe / Colour	€
84355	22,5	12,5	0,80	■	12,50



## Schale „ZEN“

bowl  
cuenco  
bol



	cm	↑ cm	ltr	Farbe / Colour	€
83712	21 x 21	11	1,40	■	13,60



## Schale „ZEN“

bowl  
cuenco  
bol

	Ø cm	↑ cm	ltr.	Farbe / Colour	€
84348	10,0	7,0	0,08		3,50
84349	10,0	7,0	0,08		3,50
84351	12,5	8,5	0,15		5,20
84353	16,0	10,0	0,30		8,30

stapelbar  
stackable

## Schale „ZEN“

bowl  
cuenco  
bol

	cm	↑ cm	ltr.	Farbe / Colour	€
83735	25,0 x 13,5	4	0,25		5,20
83739	30,5 x 17,5	5	0,60		10,30



## Schale „ZEN“

bowl  
cuenco  
bol

	cm	↑ cm	ltr.	Farbe / Colour	€
83716	17,5 x 17,5	7	0,5		8,00



## Schale „ZEN“

bowl  
cuenco  
bol

	cm	↑ cm	ltr.	Farbe / Colour	€
83725	10,5 x 10,5	3	0,06		3,00
83727	10,5 x 10,5	3	0,06		3,00



## Dipschälchen „ZEN“

dip bowl  
cuenco para dip  
bol para dip

	Ø cm	↑ cm	ltr.	Farbe / Colour	VE / unit	€ / pc.
83721	8	1,5	0,03		24	1,30
83723	8	1,5	0,03		24	1,30



## Schale „ZEN“

bowl  
cuenco  
bolMAX  
70°C

	cm	↑ cm	ltr.	Farbe / Colour	€
83718	12 x 12	4	0,2		5,50
83720	12 x 12	4	0,2		5,50



## Schale „ZEN“

bowl  
cuenco  
bolMAX  
70°C

	cm	↑ cm	ltr.	Farbe / Colour	€
83726	13 x 11	3,5	0,1		3,20
83728	13 x 11	3,5	0,1		3,20



## Schale „ZEN“

bowl  
cuenco  
bolMAX  
70°C

	cm	↑ cm	ltr.	Farbe / Colour	€
83730	11 x 10	3	0,04		2,80
83732	11 x 10	3	0,04		2,80



## Schale „ZEN“

bowl  
cuenco  
bolMAX  
70°C

	cm	↑ cm	ltr.	Farbe / Colour	€
83722	17,5 x 15,5	5,5	0,2		7,40
83724	17,5 x 15,5	5,5	0,2		7,40



## Schale „ZEN“

bowl  
cuenco  
bolMAX  
70°C

	cm	↑ cm	ltr.	Farbe / Colour	€
83935	14,5 x 12,5	5	0,2		5,60



## Schale „ZEN“

bowl  
cuenco  
bolMAX  
70°C

	Ø cm	↑ cm	ltr.	Farbe / Colour	€
83932	11,5	4	0,15		5,30
83933	11,5	4	0,15		5,30



83946

## Schale „ZEN“

bowl  
cuenco  
bol

	cm	↑ cm	ltr.	Farbe / Colour	€
83946	9 x 7	2,5	0,05	■	4,00
83947	9 x 7	2,5	0,05	■	4,00



## Schale „ZEN“

bowl  
cuenco  
bol

	cm	↑ cm	Farbe / Colour	€
83949	14 x 9	2,5	■	4,50



## Tablett / Teller „ZEN“

tray / plate  
bandeja / plato  
plateau / assiette

	Ø cm	↑ cm	Farbe / Colour	€
83941	28	3	■	11,50



83742

## Tablett / Sushiboard „ZEN“

tray / sushiboard  
bandeja para sushi  
plateau sushi

	cm	↑ cm	Farbe / Colour	€
83742	22,5 x 9,5	3	■	5,00
83744	22,5 x 9,5	3	■	5,00



## Tablett / Sushiboard „ZEN“

tray / sushiboard  
bandeja para sushi  
plateau sushi

	cm	↑ cm	Farbe / Colour	€
83740	22 x 12	3	■	6,80

# FRIDA





# FRIDA





Schale „FRIDA LOCK“

bowl  
cuenco  
bol



Schalen lassen sich durch Drehmechanismus mit dem Ständer fest verbinden

bowls can be firmly connected to the stand by a turning mechanism

los cuencos se pueden conectar firmemente al soporte mediante un mecanismo giratorio

les bols peuvent être solidement reliés au présentoir au moyen d'un mécanisme rotatif

	Ø cm	↑ cm	ltr.	Farbe / Colour	€
84920	21,5	7/8,5	1,0		34,00
84921	21,5	7/8,5	1,0		34,00
84922	25,0	8/11	1,6		42,60
84923	25,0	8/11	1,6		42,60
84924	28,5	10/14	2,6		46,60
84925	28,5	10/14	2,6		46,60

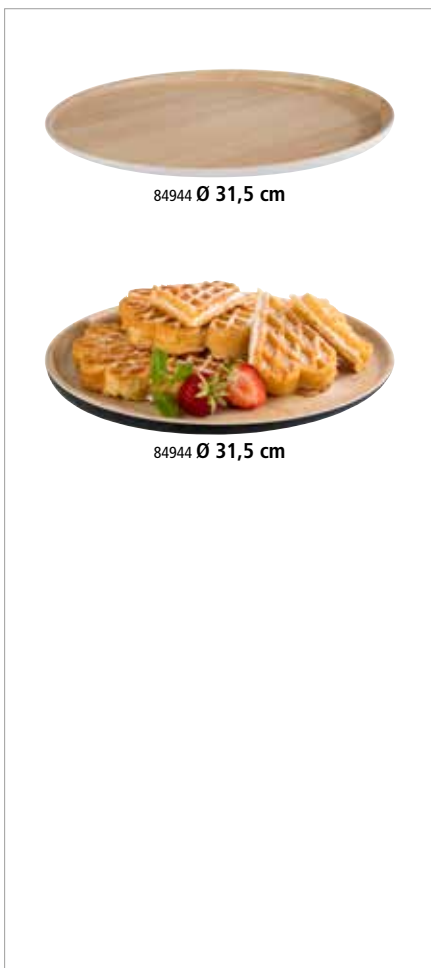

Tablett / Platte „FRIDA LOCK“

tray  
bandeja  
plateau



Tabletts lassen sich durch Drehmechanismus mit dem Ständer fest verbinden

trays can be firmly connected to the stand by a turning mechanism

las bandejas se pueden conectar firmemente al soporte mediante un mecanismo giratorio

les plateaux peuvent être solidement reliés au présentoir au moyen d'un mécanisme rotatif

	Ø cm	↑ cm	Farbe / Colour	€
84943	31,5	1,5/2,5		30,50
84944	31,5	1,5/2,5		30,50





### Ständer „FRIDA LOCK“

stand  
soporte  
présentoir



	Ø cm	↑ cm	Farbe / Colour	€
84926	16,5	8	White	9,90
84927	16,5	8	Black	9,90



### Ständer „FRIDA LOCK“

stand  
soporte  
présentoir



	Ø cm	↑ cm	Farbe / Colour	€
84928	16,5	12	White	17,00
84929	16,5	12	Black	17,00



### Haube

cover  
campana  
cloche



	Ø cm	↑ cm	fits to	€
06519	21	17		30,00
06520	30	22	00468, 00469, 84943, 84944	37,00
06521	36	27		74,00
	Ø cm	↑ cm	fits to	€
06525	30	40	00468, 00469, 84943, 84944	32,00

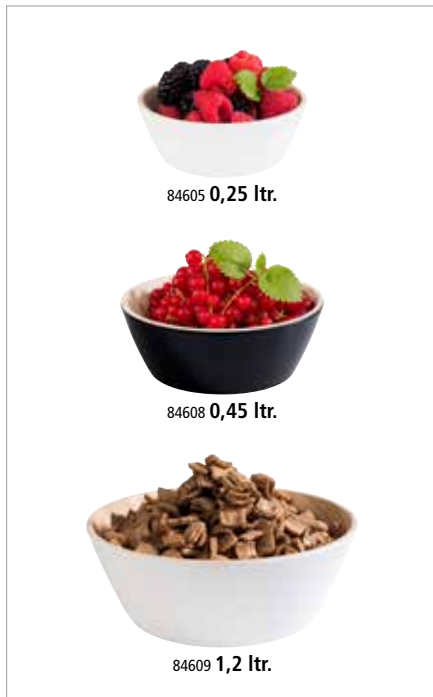

**Schale „FRIDA“**  
bowl  
cuenco  
bol

original  
APS  
melamine

MAX  
70°C

	Ø cm	↑ cm	ltr.	Farbe / Colour	€
84605	12,5	4,5	0,25		11,00
84606	12,5	4,5	0,25		11,00
84607	15,0	5,5	0,44		18,00
84608	15,0	5,5	0,44		18,00
84609	20,0	7,5	1,20		27,00
84610	20,0	7,5	1,20		27,00

passende Deckel / suitable lid / tapa adecuada / couvercle approprié

	Ø cm	↑ cm	fits to	€
84963	13,0	2,5	84605, 84606	3,40
84964	16,0	2,5	84607, 84608	3,80



**Schale „FRIDA“**  
bowl  
cuenco  
bol

original  
APS  
melamine

MAX  
70°C

NON  
SLIP FEET

	Ø cm	↑ cm	ltr.	Farbe / Colour	€
84611	22,0	10,5	2,2		29,30
84612	22,0	10,5	2,2		29,30
84613	26,5	10,5	3,4		36,70
84614	26,5	10,5	3,4		36,70

mit Antirutschfüßchen  
with non-slip feet



**Schale „FRIDA“**  
bowl  
cuenco  
bol

original  
APS  
melamine

MAX  
70°C

	Ø cm	↑ cm	ltr.	Farbe / Colour	€
84930	8,5	3,5	0,1		3,80
84931	8,5	3,5	0,1		3,80
84932	21,5	7,5	1,8		26,00
84933	21,5	7,5	1,8		26,00
84934	30,0	9,5	4,7		42,80
84935	30,0	9,5	4,7		42,80

passende Deckel / suitable lid / tapa adecuada / couvercle approprié

	Ø cm	↑ cm	fits to	€
84962	9,0	2,5	84930, 84931	3,10



84936 0,37 ltr.



84959 0,85 ltr.



84561 2,65 ltr.

## Schale „FRIDA“

bowl  
cuenco  
bol

	cm	↑ cm	ltr.	Farbe / Colour	€
84936	12,5 x 12,5	4,5	0,37		7,60
84937	12,5 x 12,5	4,5	0,37		7,60
84558	16,5 x 16,5	5,5	0,85		11,50
84559	16,5 x 16,5	5,5	0,85		11,50
84561	25,0 x 25,0	7,5	2,65		21,40
84562	25,0 x 25,0	7,5	2,65		21,40

passende Deckel / suitable lid / tapa adecuada / couvercle approprié

	cm	↑ cm	fits to	€
84965	13,0 x 13,0	2,5	84936, 84937	3,10
84966	17,0 x 17,0	2,5	84558, 84559	3,40



84555 GN 1/9



84584 GN 1/6



84586 GN 1/4



84565 GN 2/4



84589 GN 1/2

## GN Schale „FRIDA“

GN bowl  
GN cuenco  
GN bol

	cm	↑ cm	ltr.	GN	Farbe / Colour	€
84555	17,6 x 10,8	5,5	1,5	1/9		10,20
84556	17,6 x 10,8	5,5	1,5	1/9		10,20
84583	17,6 x 16,2	7,5	1,0	1/6		15,50
84584	17,6 x 16,2	7,5	1,0	1/6		15,50
84586	26,5 x 16,2	7,5	1,8	1/4		23,60
84587	26,5 x 16,2	7,5	1,8	1/4		23,60
84564	53 x 16,2	7,5	3,65	2/4		31,60
84565	53 x 16,2	7,5	3,65	2/4		31,60
84589	32,5 x 26,5	7,5	4,0	1/2		32,50
84590	32,5 x 26,5	7,5	4,0	1/2		32,50

passende Deckel / suitable lid / tapa adecuada / couvercle approprié

	cm	↑ cm	fits to	€
84968	18,0 x 11,0	2,5	84555, 84556	4,00
84967	18,0 x 16,5	2,5	84583, 84584	3,80





84592 3,5 ltr.

84593 3,5 ltr.

83601

Schale „FRIDA“

bowl  
cuenco  
bol



	cm	↑ cm	ltr.	Farbe / Colour	€
84592	25 x 25	12	3,5		32,50
84593	25 x 25	12	3,5		32,50

Deckel „PURE“ mit Löffelaussparung

cover with notched for spoons  
tapa con espacio para la cuchara  
couverture avec encoche pour la louche



	cm	↑ cm	fits to	€
83601	25 x 25	1,5	84561, 84562, 84592, 84593	10,40



mit Deckel stapelbar  
stackable with cover



84548 1,2 ltr.

Schale „FRIDA“

bowl  
cuenco  
bol



	cm	↑ cm	ltr.	Farbe / Colour	€
84948	33,5 x 21	4	1,2		19,00



als Schütte geeignet  
suitable as a chute

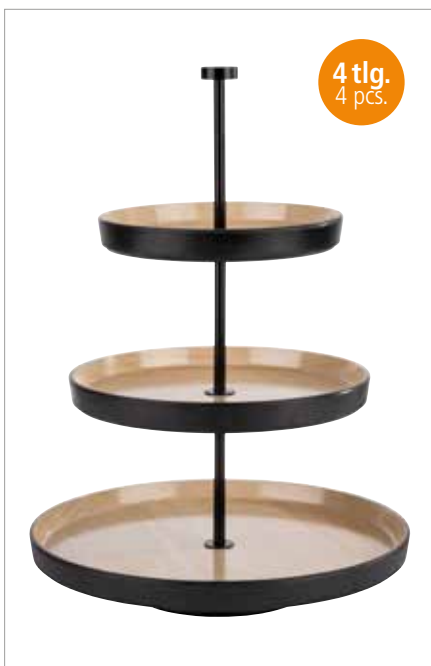

4 tlg.  
4 pcs.

3-stufige Etagère „FRIDA“

3-tier tray  
bandeja con 3 alturas  
étagère carré 3 hauteurs



1 Gestell aus Edelstahl, schwarz, 3 Schalen aus Melamin: Ø 20 / 25 / 32 cm  
1 stainless steel frame, black, 3 melamine bowls: Ø 20 / 25 / 32 cm  
1 soporte de acero inoxidable, negro, 3 cuencos de melamina: Ø 20 / 25 / 32 cm  
1 support en acier inox, noir, 3 bols en mélamine: Ø 20 / 25 / 32 cm

	Ø cm	↑ cm	Farbe / Colour	€
85211	20 / 25 / 32	43		92,00

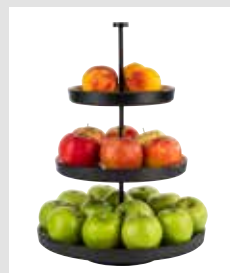

2 tlg.  
2 pcs.

85230 Ø 25,5 cm



+



33282

+



85231 Ø 33 cm

**Schale, 2-teilig „FRIDA“**bowl, 2 pcs.  
cuenco, set de 2  
bol, set de 2

inklusive Abtropfeinsatz

including drip tray  
con escurridor  
avec égouttoir

	Ø cm	↑ cm	Farbe / Colour	€
85230	25,5	6	■ ■	27,00
85231	33,0	6	■ ■	46,00

**Buffetständer**buffet stand  
soporte para buffet  
présentoir buffet

Metall, mit schwarzer Antirutschbeschichtung, für Schalen Nr. 85230, 85231

metal, with black anti-slide coating, for bowls no. 85230, 85231

metal, con revestimiento antideslizante negro, para cuencos 85230, 85231

métal, avec revêtement antidérapant noir, pour bols 85230, 85231

	Ø cm	↑ cm	Farbe / Colour	€
33282	23 / 30,5	17	■	42,00

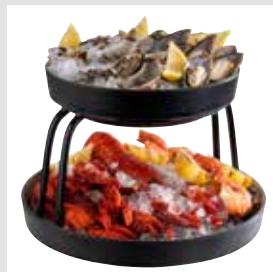
Präsentationsmöglichkeit  
presentation exampleinklusive Abtropfeinsatz  
including drip tray

# OAK LIGHT



84205 GN 1/1



84206 GN 1/2



84207 GN 1/3



84209 GN 2/4

## GN Tablett „OAK LIGHT“

GN tray  
GN bandeja  
GN plateau



	cm	↑ cm	GN	€
84205	53,0 x 32,5	1,5	1/1	43,00
84206	32,5 x 26,5	1,5	1/2	22,00
84207	32,5 x 17,6	1,5	1/3	15,60
84209	53,0 x 16,2	1,5	2/4	25,00



84205  
GN 1/1



84206  
GN 1/2



84206  
GN 1/2



84209  
GN 2/4





**GN Tablett „ZERO“**

GN tray  
GN bandeja  
GN plateau

glatte, hochglänzende Oberfläche  
smooth and shiny surface  
superficie lisa con acabado brillante  
surface lisse et finition brillante



	cm	↑ cm	GN	Farbe / Colour	€
84185	53,0 x 32,5	1,5	1/1		41,40
84186	32,5 x 26,5	1,5	1/2		22,40
84187	32,5 x 17,6	1,5	1/3		15,60
84188	26,5 x 16,2	1,5	1/4		12,60
84189	53,0 x 16,2	1,5	2/4		24,60

passende Hauben / suitable covers / campanas adecuadas / cloches appropriées

	cm	↑ cm	* mm	GN	€
11042	53,0 x 32,5	9,5	3	1/1	32,00
11041	32,5 x 26,5	9,5	3	1/2	23,00
11043	32,5 x 17,6	10,5	3	1/3	17,00
11044	53,0 x 16,2	10,5	3	2/4	23,00



mit Antirutschfüßchen  
with non-slip feet



**GN Tablett „DRIFTWOOD“**

GN tray  
GN bandeja  
GN plateau

die Melaminplatten (Holzoptik) haben eine leicht wellige Oberfläche und wirken optisch wie aus Holz gefertigt

the melamine trays (wood look) have a slightly wavy surface and look visually as made of natural wood

las bandejas de melamina (imitación madera) tienen una superficie ligeramente ondulada y parecen estar hechas de madera natural

les plateaux de mélamine (imitation bois) ont une surface légèrement ondulée et donnent une impression visuelle de bois naturelle



	cm	↑ cm	GN	€
84180	53,0 x 32,5	1,5	1/1	43,70
84181	32,5 x 26,5	1,5	1/2	22,40
84182	32,5 x 17,6	1,5	1/3	15,60



Oberflächenansicht  
surface view

# SLATE



Die schwarzen Melaminplatten überzeugen mit ihrem edlen und schlichten Schieferlook und einer rauhen Oberfläche.

The black melamine trays convince with their noble and simple slate look and a rough surface.

Las bandejas de melamina negras convencen por su aspecto de pizarra elegante y discreto y una superficie áspera.

Les plateaux en mélamine noirs convainquent grâce au aspect de l'ardoise élégant et discret et une surface rugueuse.



## GN Tablett „SLATE“

GN tray  
GN bandeja  
GN plateau



	cm	↑ cm	GN	€
83955	53,0 x 32,5	1	1/1	47,20
83956	32,5 x 26,5	1	1/2	25,00
83957	32,5 x 17,6	1	1/3	17,30
83958	26,5 x 16,2	1	1/4	13,80
83971	53,0 x 16,2	1	2/4	27,50



## GN Tablett „SLATE“

GN tray  
GN bandeja  
GN plateau

massive Metallgriffe verchromt inkl. fest verschraubten 4 cm Distanzstücken  
chrome plated handles, incl. mounted 4 cm distance pillars  
asas cromadas, incluye distanciadores de 4 cm firmemente montados  
poignées chromées, y compris piliers de distance montées de 4 cm



	cm	↑ cm	GN	€
83980	53 x 32,5	6	1/1	56,40



**GN Tablett „SLATE“**

GN tray  
GN bandeja  
GN plateau



	cm	↑ cm	GN	€
83981	53 x 32,5	1,5	1/1	47,40



Schieferoptik  
slate look



83994

**Tablett „SLATE“**

tray  
bandeja  
plateau



	Ø cm	↑ cm	€
83992	30	1	22,60
83994	40	1	35,90



11056

85099

30336

**Tablett „SLATE“**

tray  
bandeja  
plateau

passend zu Etagère 30336  
suitable for 2-tier tray 30336  
adecuado para soporte 2 alturas 30336  
adapté à étagère 2 niveaux



	cm	↑ cm	€
85099	28,0 x 15,5	1,0	13,60



Haube / cover / campana / cloche

	cm	↑ cm	€
11056	26,0 x 12,0	10,0	6,00



84245

83601

83600

**Schale „SLATE“**

bowl  
cuenco  
bol



	cm	↑ cm	litr.	€
84244	19 x 19	9	1,5	21,00
84245	25 x 25	12	3,8	36,00

**Deckel „PURE“ mit Löffelaussparung**

cover with notched for spoons  
tapa con espacio para la cuchara  
couverture avec encoche pour la louche

	cm	↑ cm	fits to	€
83600	19 x 19	1,5	84244	8,20
83601	25 x 25	1,5	84245	10,40

# SLATE ROCK



## Tablett „SLATE-ROCK“

tray  
bandeja  
plateau



Die schwarzen Melaminplatten überzeugen mit ihrem Schieferlook  
The black melamine trays convince with their slate look  
Las bandejas de melamina negras convencen por su aspecto de pizarra  
Les plateaux en mélamine noirs convainquent grâce au aspect de l'ardoise

	cm	↑ cm	Griff / handle cm	€
84258	40 x 20	1,5	13	29,90
84259	48 x 20	1,5	13	35,90
	Ø cm	↑ cm	Griff / handle cm	€
84257	30	1,5	12	24,20

## OAK



## Tablett „OAK“

tray  
bandeja  
plateau

	cm	↑ cm	Griff / handle cm	€
84178	40 x 20	1,5	13	31,00
84179	48 x 20	1,5	13	38,00



## Tablett „OAK“

tray  
bandeja  
plateau

	Ø cm	↑ cm	Griff / handle cm	€
84177	30	1,5	12	25,30



## Schale „OAK“

bowl  
cuenco  
bol

	cm	↑ cm	VE / unit	€ / pc.
84434	11,5 x 7,0	2,5	20	4,60



Eine derbe Oberflächenstruktur schafft ein natürliches Erscheinungsbild.  
Die schwarzen Schalenvarianten mit braunem Rand inszenieren Ihr Gericht sehr stilvoll.

A rough surface structure creates a natural appearance.  
The black bowls and trays with brown border stage your dishes in a very stylish way.

La estructura rugosa de la superficie crea una apariencia natural.  
Los diferentes cuencos negros con borde marron ponen con mucho estilo en escena sus platos.

La structure de surface rugueuse crée une apparence naturelle.  
Les différents bols noirs avec rebord marron mettent élégamment en scène vos plats.



**Blattschale „MARONE“**  
leaf  
fuente en forma de hoja  
plateau feuille



	cm	↑ cm	ltr.	€
84100	25,5 x 14	5,5	0,4	9,80
84101	36,0 x 19	8,0	0,9	15,00



**Schale „MARONE“**  
bowl  
cuenco  
bol



	cm	↑ cm	ltr.	€
84731	16,5 x 10	5,5	0,25	12,00
84732	22,0 x 13	7,5	0,6	14,40
84733	27,5 x 19	9,0	1,4	17,20



Oberflächenansicht  
surface view



84107 **0,05 ltr.**



84108 **0,04 ltr.**

Schale „MARONE“

bowl  
cuenco  
bol



	Ø cm	↑ cm	ltr.	VE / unit	€ / pc.
84107	8,5	2,5	0,05	12	6,50
84108	11,5	3,0	0,04	12	6,90



84115 **0,13 ltr.**



84116 **0,2 ltr.**

Schale „MARONE“

bowl  
cuenco  
bol



	Ø cm	↑ cm	ltr.	€
84115	11	3,5	0,13	6,50
84116	14	4,0	0,20	7,20



84109 **0,2 ltr.**

Schale „MARONE“

bowl  
cuenco  
bol



	Ø cm	↑ cm	ltr.	€
84109	11	5,5	0,2	6,70



84111 **0,8 ltr.**

Schale „MARONE“

bowl  
cuenco  
bol



	Ø cm	↑ cm	ltr.	€
84110	14	6,0	0,30	7,80
84111	19	8,0	0,80	14,00
84112	21	8,5	1,00	14,50
84113	24	9,5	1,40	17,00



84174 **2,0 ltr.**

Schale „MARONE“

bowl  
cuenco  
bol



	Ø cm	↑ cm	ltr.	€
84174	30,5	8,5	2	24,70

## MARONE



### Tablett „MARONE“

tray  
bandeja  
plateau



MAX  
70°C



	cm	↑ cm	€
84117	19,5 x 9,5	2	10,00
84118	39,0 x 16,0	3	19,80



### Tablett „MARONE“

tray  
bandeja  
plateau



MAX  
70°C



	cm	↑ cm	€
84119	32,5 x 23,5	4,5	19,80



### Tablett „MARONE“

tray  
bandeja  
plateau



MAX  
70°C



	cm	↑ cm	€
84104	22,5 x 15	3	12,00
84105	27,5 x 11	2	12,00



### Tablett „MARONE“

tray  
bandeja  
plateau



MAX  
70°C



	cm	↑ cm	€
84103	14,5 x 14,5	2	6,50



### Tablett „MARONE“

tray  
bandeja  
plateau



MAX  
70°C



	cm	↑ cm	€
84106	26,5 x 16,5	4	13,80



### Teller „MARONE“

plate  
plato  
assiette



MAX  
70°C



	Ø cm	↑ cm	€
84729	20,5	2,5	8,70
84730	28,0	3,5	10,70



# GLAMOUR



84377

84381



## Schale „GLAMOUR“

bowl  
cuenco  
bol



	Ø cm	↑ cm	ltr.	€
84365	8	3	0,05	2,00



## Schale „GLAMOUR“

bowl  
cuenco  
bol



	Ø cm	↑ cm	ltr.	€
84366	12	5	0,25	2,60



84377

84378

## Tablett „GLAMOUR“

tray  
bandeja  
plateau



	cm	↑ cm	€
84377	22 x 12	3,0	4,00
84378	37 x 11	2,5	10,90

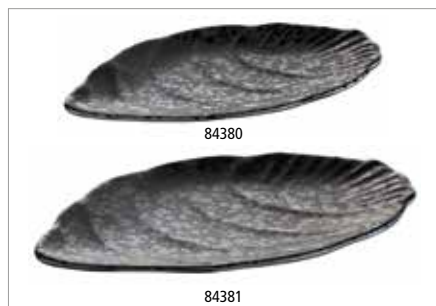

84380

84381

## Tablett „GLAMOUR“

tray  
bandeja  
plateau



	cm	↑ cm	€
84380	25,0 x 15,5	1,5	3,60
84381	30,5 x 19,0	1,5	5,60



## Tablett „GLAMOUR“

tray  
bandeja  
plateau



	cm	↑ cm	€
84379	30 x 11	3	6,00



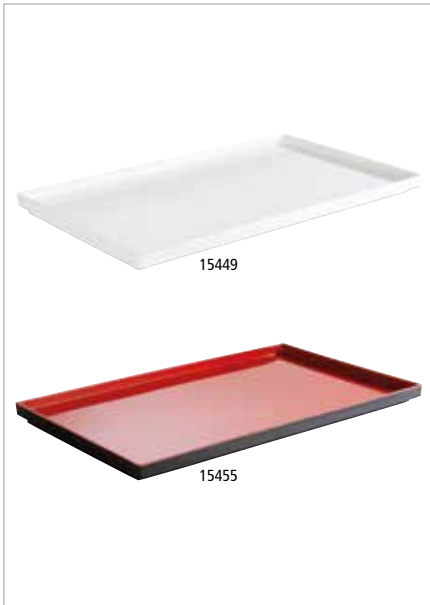

**GN Tablett „ASIA PLUS“**

GN tray  
GN bandeja  
GN plateau



	cm	↑ cm	GN	Farbe / Colour	€
15449	53,0 x 32,5	3	1/1		43,00
15450	32,5 x 26,5	3	1/2		24,00
15451	32,5 x 17,6	3	1/3		17,80
15452	26,5 x 16,2	3	1/4		14,00
15453	35,4 x 32,5	3	2/3		31,00
15454	53,0 x 16,2	3	2/4		28,00
15455	53,0 x 32,5	3	1/1		56,00
15456	32,5 x 26,5	3	1/2		27,80
15457	32,5 x 17,6	3	1/3		22,80
15458	26,5 x 16,2	3	1/4		18,80
15460	53,0 x 16,2	3	2/4		35,00



**Schale „ASIA PLUS“**

bowl  
cuenco  
bol



	Ø cm	↑ cm	litr.	Farbe / Colour	€
15400	7,5	3,5	0,06		2,60
15401	9,5	4,5	0,13		3,70
15402	13,0	5,5	0,35		6,30
15403	16,0	7,0	0,60		8,60
15404	20,0	8,0	1,10		13,80
15416	7,5	3,5	0,06		2,60
15417	9,5	4,5	0,13		3,70
15418	13,0	5,5	0,35		6,30
15419	16,0	7,0	0,60		8,60
15420	20,0	8,0	1,10		13,80
15421	24,0	9,5	2,20		20,70



**Teller „ASIA PLUS“**

plate  
plato  
assiette



	Ø cm	↑ cm	Farbe / Colour	€
15424	11,0	2		3,30
15425	16,0	2		5,80



**Bento Box „ASIA PLUS“**

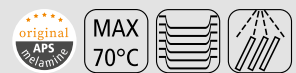

	Ø cm	↑ cm	litr.	Farbe / Colour	€
15461	7,5	3,0	0,04		2,30
15462	7,5	6,5	0,13		3,30
15467	7,5	3,0	0,04		3,30



### Bento Box „ASIA PLUS“

original APS melamin  
MAX 70°C

	cm	↑ cm	ltr.	Farbe / Colour	€
15473	7,5 x 7,5	3,0	0,05		2,60
15474	7,5 x 7,5	6,5	0,16		3,50
15485	7,5 x 7,5	3,0	0,05		4,10
15475	15,5 x 7,5	3,0	0,10		4,10
15477	15,5 x 9,5	3,0	0,15		4,40

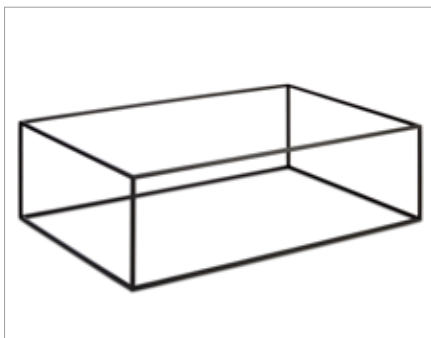

### GN Buffetständer „ASIA PLUS“

GN buffet stand  
GN soporte para buffet  
GN présentoir buffet

METALL

	cm	GN	Farbe / Colour	€
15504	53,0 x 32,5 / 53,0 x 16,2	1/1 / 2/4		29,90
15505	32,5 x 26,5 / 26,5 x 16,2	1/2 / 1/4		17,80
15506	32,5 x 17,5 / 35,4 x 32,5	1/3 / 2/3		22,80

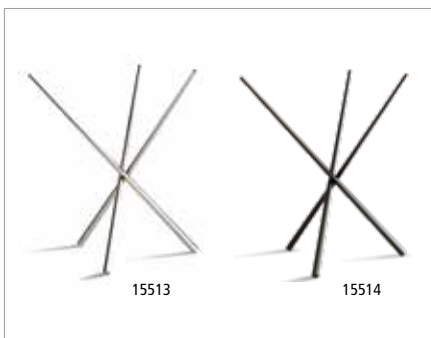

### Buffetständer „ASIA PLUS“

buffet stand  
soporte para buffet  
présentoir buffet

EDELSTAHL STAINLESS INOX 18/10

	Ø cm	↑ cm	Farbe / Colour	€
15513	20,5 / 16,5	20	stainless steel	16,80
15514	20,5 / 16,5	20		15,60



### Korb / Ständer „APS PLUS“

basket / riser  
cesta / soporte  
corbeille / support

EDELSTAHL STAINLESS INOX

	Ø cm	↑ cm	Farbe / Colour	€
15320	10,5 / 8	8		16,40
15324	10,5 / 8	8		16,40
15322	10,5 / 8	8		15,00

**APS+**



15215 0,6 ltr.



15216 1,5 ltr.



15217 3,5 ltr.

Schale „APS+“  
bowl  
cuenco  
bol



	cm	↑ cm	ltr.	Farbe / Colour	€
15215	13,0 x 13,0	7	0,6		10,40
15216	20,0 x 20,0	7	1,5		24,40
15217	24,0 x 24,0	9	3,5		36,80

# HALFTONE



**Fingerfoodlöffel „HALFTONE“**  
party spoon  
cuchara party  
cuillère party



MAX  
70°C



	Ø cm	↑ cm	Farbe / Colour	VE / unit	€ / pc.
84158	5,5	7	■ ■	24	3,70



**Fingerfoodlöffel „HALFTONE“**  
party spoon  
cuchara party  
cuillère party



MAX  
70°C



	cm	↑ cm	Farbe / Colour	VE / unit	€ / pc.
84128	14,5 x 4,5	4,5	■ ■	12	3,70



**Tablett „HALFTONE“**  
tray  
bandeja  
plateau



MAX  
70°C



	cm	↑ cm		€
84125	24,5 x 15,0	3		8,70



Schale „HALFTONE“

bowl  
cuenco  
bol



	Ø cm	↑ cm	ltr.	VE / unit	€ / pc.
84217	8	4	0,1	12	4,00



Schale „HALFTONE“

bowl  
cuenco  
bol



	cm	↑ cm	ltr.	€
84130	11,5 x 7,0	4,0	0,05	3,40
84131	14,0 x 8,0	4,5	0,10	4,30
84133	17,5 x 13,5	6,5	0,35	7,20
84134	24,0 x 17,5	7,5	0,8	12,90



Schale „HALFTONE“

bowl  
cuenco  
bol



	Ø cm	↑ cm	ltr.	€
84135	16,5	7,5	0,65	10,20

# PADELLA



Schale „PADELLA“

bowl  
cazuelita  
plat 2 anses „cocotte“



	Ø cm	↑ cm	ltr.	Griff / handle cm	€
85150	21	9	1,5	5 x 3,5	15,40
85151	28	9	3,0	5 x 3,5	23,00



stapelbar und rutschfest  
stackable and nonslip



PURE



Tablett „PURE“

tray  
bandeja  
plateau



	cm	↑ cm	GN	Farbe / Colour	€
83401	53,0 x 32,5	3	1/1		42,00
83433	53,0 x 16,2	3	2/4		25,00
83480	32,5 x 26,5	3	1/2		22,60
83481	32,5 x 17,6	3	1/3		17,00
83482	26,5 x 16,2	3	1/4		12,40

83597	40,0 x 30,0	3	Bäcker-Maß		32,00
-------	-------------	---	------------	--	-------

	cm	↑ cm	GN	Farbe / Colour	€
83479	53,0 x 32,5	3	1/1		42,00
83434	53,0 x 16,2	3	2/4		24,00
83490	32,5 x 26,5	3	1/2		22,00
83491	32,5 x 17,6	3	1/3		17,00
83492	26,5 x 16,2	3	1/4		12,40

83592	40,0 x 30,0	3	Bäcker-Maß		32,00
-------	-------------	---	------------	--	-------



Tablett „PURE“

tray  
bandeja  
plateau



	cm	↑ cm	Farbe / Colour	€
83403	35,5 x 18,0	3		14,00
83417	30,0 x 21,0	3		16,40
83402	53,0 x 18,0	3		28,00



Tablett quadratisch „PURE“

tray square  
bandeja cuadrada  
plateau carré



	cm	↑ cm	Farbe / Colour	€
83418	18,0 x 18,0	3		8,20
83407	21,0 x 21,0	3		11,80
83406	26,5 x 26,5	3		17,90
83405	37,0 x 37,0	3		24,40





**Tablett / Teller „PURE“**

tray / plate  
bandeja / plato  
plateau / assiette



	Ø cm	↑ cm	Farbe / Colour	€
83884	31	2,5		21,60
83869	38	2,5		24,70



**Teller, rund „CASUAL“**

plate, round  
plato, redondo  
assiette, ronde



	Ø cm	↑ cm	€
83500	22,5	2,5	8,60
83514	26,5	2,5	10,30



**Schale „PURE“**

bowl  
cuenco  
bol



	Ø cm	↑ cm	ltr.	Farbe / Colour	€
83450	5,5	4,0	0,02		2,00
83419	9,0	4,5	0,09		3,60
83453	13,0	6,5	0,30		7,60
83455	15,0	7,5	0,45		12,00
83415	20,0	10,5	1,25		21,60
	Ø cm	↑ cm	ltr.	Farbe / Colour	€
83451	5,5	4,0	0,02		2,00
83452	9,0	4,5	0,09		3,60
83454	13,0	6,5	0,30		7,60



**Schale „PURE“**

bowl  
cuenco  
bol



0,05 ltr. - 8 ltr.

	cm	↑ cm	ltr.	Farbe / Colour	€
84424	6,5 x 6,5	3,0	0,05		2,60
83414	9,0 x 9,0	4,0	0,14		4,20
83410	12,5 x 12,5	6,5	0,40		6,80
83409	19,0 x 19,0	9,0	1,50		22,40
83408	25,0 x 25,0	12,0	3,80		36,70
84425	32,0 x 32,0	14,0	8,0		44,80
	cm	↑ cm	ltr.	Farbe / Colour	€
84426	6,5 x 6,5	3,0	0,05		2,60
83466	9,0 x 9,0	4,0	0,14		4,20
83467	12,5 x 12,5	6,5	0,40		6,80
83468	19,0 x 19,0	9,0	1,50		22,40
83469	25,0 x 25,0	12,0	3,80		36,70
84427	32,0 x 32,0	14,0	8,0		44,80



Schale „PURE COLOR“

bowl  
cuenco  
bol



	cm	↑ cm	ltr.	Farbe / Colour	€
85260	19 x 19	9	1,5	sand	22,40
85261	25 x 25	12	3,8	sand	36,70
	cm	↑ cm	ltr.	Farbe / Colour	€
85266	19 x 19	9	1,5	olive	22,40
85267	25 x 25	12	3,8	olive	36,70



Schale „SLATE“

bowl  
cuenco  
bol



	cm	↑ cm	ltr.	€
84244	19 x 19	9	1,5	21,00
84245	25 x 25	12	3,8	36,00



**Deckel „PURE“ mit Löffelaussparung**

cover with notched for spoons  
tapa con espacio para la cuchara  
couverture avec encoche pour la louche



	cm	↑ cm	fits to	€
83600	19 x 19	1,5	84409, 84417, 84422, 83409, 83468, 83572, 83573	8,20
83601	25 x 25	1,5	84408, 84418, 84423, 84430, 83575, 83574, 83469, 83408	10,40



mit Deckel stapelbar  
stackable with cover



**Schale „PURE“**

bowl  
cuenco  
bol



	cm	↑ cm	ltr.	€
83498	38,5 x 15,5	7,5	1,50	34,00
83499	51,0 x 15,5	7,5	2,40	44,90



**GN Tablett „FRAMES“**

GN tray  
GN bandeja  
GN plateau

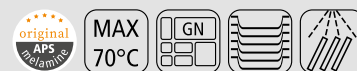

	cm	↑ cm	GN	€
84046	53,0 x 32,5	2	1/1	33,00
84047	32,5 x 26,5	2	1/2	18,40
84048	32,5 x 17,6	2	1/3	12,60



# FLOAT



- Ideal für den Thekenbereich
- stapelbar mit Löffel und Deckel
- Schalenboden fixiert sich auf dem Deckel
- rutschfest (Antirutschfüßchen)

- ideal for the counter area
- stackable with spoon and lid
- the bottom of the bowl is fixed on the lid
- non-slip (with non-slip feet)

- ideal para la zona del mostrador
- apilable con cuchara y tapa
- el fondo del cuenco se fija en la tapa
- antideslizante (con pies antideslizantes)

- idéal pour l'aire de comptoir
- empilable avec cuillère et couvercle
- le fond du bol se fixe sur le couvercle
- antidérapant (avec pieds antidérapants)



## Schale „FLOAT“ bowl cuenco bol



	Ø cm	↑ cm	ltr.	Farbe / Colour	VE / unit	€ / pc.
83900	5,5	3,0	0,03		36	1,80
83902	9,0	4,5	0,15			3,20
83904	13,0	6,5	0,45			7,40
83906	15,0	7,5	0,70			11,00
83908	20,5	10,0	1,90			18,20
83901	5,5	3,0	0,03		36	1,80
83903	9,0	4,5	0,15			3,20
83905	13,0	6,5	0,45			7,40
83907	15,0	7,5	0,70			11,00
83909	20,5	10,0	1,90			18,20



Schale „FLOAT“

bowl  
cuenco  
bol



	cm	↑ cm	ltr.	Farbe / Colour	VE / unit	€ / pc.
83910	5,5 x 5,5	3,0	0,03	White	36	1,80
83912	9,0 x 9,0	4,5	0,16	White		3,60
83914	12,5 x 12,5	6,0	0,50	White		7,00
83916	19,0 x 19,0	9,5	1,90	White		16,40
83918	25,0 x 25,0	12,0	4,70	White		30,00
83911	5,5 x 5,5	3,0	0,03	Black	36	1,80
83913	9,0 x 9,0	4,5	0,16	Black		3,60
83915	12,5 x 12,5	6,0	0,50	Black		7,00
83917	19,0 x 19,0	9,5	1,90	Black		16,40
83919	25,0 x 25,0	12,0	4,70	Black		30,00



stapelbar  
stackable



GN Tablett „FLOAT“

GN tray  
GN bandeja  
GN plateau



	cm	↑ cm	GN	Farbe / Colour	€
83923	53,0 x 32,5	3	1/1	White	38,00
83925	32,5 x 26,5	3	1/2	White	23,00
83924	53,0 x 32,5	3	1/1	Black	38,00
83926	32,5 x 26,5	3	1/2	Black	23,00



Deckel „FLOAT“ mit Löffelaussparung

cover with notched for spoons  
tapa con espacio para la cuchara  
couverture avec encoche pour la louche



	cm	↑ cm	fits to	€
83921	19 x 19	1,3	83916, 83917	8,40
83922	25 x 25	1,3	83918, 83919	10,60

# SINUS



## GN Tablett „SINUS“

GN tray  
GN bandeja  
GN plateau



	cm	↑ cm	GN	Farbe / Colour	€
84230	53 x 32,5	2	1/1		33,40
84231	53 x 16,2	2	2/4		20,30



# APART



## GN Tablett „APART“

GN tray  
GN bandeja  
GN plateau



	cm	↑ cm	GN	€
83828	53,0 x 32,5	2,5	1/1	38,50
83830	32,5 x 26,5	2,5	1/2	21,40

# CASCADE



## Schale „CASCADE“

bowl  
cuenco  
bol



	cm	↑ cm	GN	litr.	€
83960	32,5 x 26,5	7,5	1/2	3,65	22,40
83962	26,5 x 16,2	7,5	1/4	1,50	12,70
83961	53 x 16,2	7,5	2/4	3,65	24,20



Außenmaße Gastronorm  
size Gastronorm



# GLOBAL BUFFET

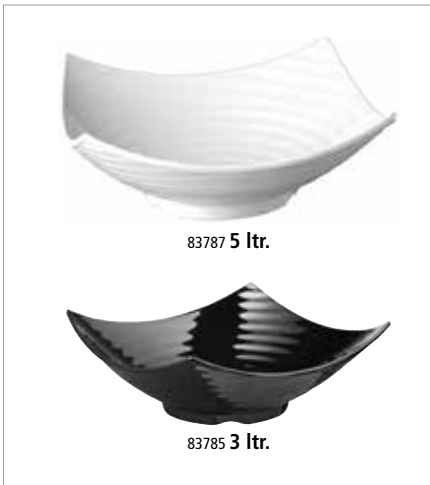

## Schale „GLOBAL BUFFET“

bowl  
cuenco  
bol



	cm	↑ cm	ltr.	Farbe / Colour	€
83785	32,5 x 32,5	12,0	3,0		25,90
83787	40,0 x 40,0	13,5	5,0		41,90
84785	32,5 x 32,5	12,0	3,0		25,90



## Schale „GLOBAL BUFFET“

bowl  
cuenco  
bol



	cm	↑ cm	ltr.	Farbe / Colour	€
83799	25,5 x 25,5	13,0	3,0		21,00
83788	32,0 x 32,0	16,5	4,5		26,40
83789	35,0 x 35,0	17,0	6,0		32,70
83790	40,0 x 40,0	17,5	8,0		41,90



## Schale „GLOBAL BUFFET“

bowl  
cuenco  
bol



	cm	↑ cm	ltr.	Farbe / Colour	€
84462	44 x 25	20	3,3		24,20



## Schale „LEAF“

bowl  
cuenco  
bol



	cm	↑ cm	ltr.	Farbe / Colour	€
84200	42 x 19,5	6,5	1,0		13,50

## CAKEPLATES



### Servier- und Tortenplatte „CASUAL“

cake plate  
porta pasteles  
présentoir à gâteaux



	Ø cm	↑ cm	€
83890	31	8	28,60
83891	31	16	36,00



### Servier- und Tortenplatte „CASUAL“

cake plate  
porta pasteles  
présentoir à gâteaux



	cm	↑ cm	€
83892	31 x 31	8	32,00
83893	31 x 31	16	39,00



### Torten- / Konditorplatte

cake stand  
soporte para pastel  
présentoir à gâteaux



Rand fixiert die Haube, mit Antirutschfüßchen  
carved edge fixes the cover, with non-slip feet  
ranura para fijar bien la campana, con pies antideslizantes  
bord rainuré pour maintenir ferme la cloche, avec pieds antidérapants

	Ø cm	↑ cm	Farbe / Colour	€
00468	31,0	3,5	White	18,40
00469	31,0	3,5	Black	18,40



### Fass, 2-teilig

bowl  
cuenco  
bol



2-teilig: Unterteil / Edelstahlschale  
2 pcs.: lower part / stainless steel bowl  
set de 2: parte inferior / cuenco de acero inoxidable  
set de 2: partie inférieure / bol en acier inox

	Ø cm	↑ cm	€
85250	26	16	49,00

#### Unterteil / lower part / parte inferior / partie inférieure

	Ø cm	↑ cm	ltr.	€
85251	25	16	4,5	38,00

#### Edelstahlschale / stainless steel bowl / cuenco de acero inoxidable / bol en acier inox

	Ø cm	↑ cm	ltr.	€
85252	26	9	3,0	12,00



Unterteil mit Eis füllen für perfekte Kühlung sensibler Speisen  
fill the bottom part with ice for perfect cooling of sensitive dishes





## Schale „BALANCE“

bowl  
cuenco  
bol

	Ø cm	↑ cm	ltr.	Farbe / Colour	€
84040	14,5	9,0	0,4		6,40
84041	21,0	13,0	1,5		14,20
84042	24,5	15,0	2,5		18,40
84043	30,0	19,5	5,0		31,00

	Ø cm	↑ cm	ltr.	Farbe / Colour	€
85040	14,5	9,0	0,4		6,40
85041	21,0	13,0	1,5		14,20
85042	24,5	15,0	2,5		18,40
85043	30,0	19,5	5,0		31,00

## Buffetständer „KING“ / buffet stand / soporte para buffet / présentoir buffet

	Ø cm	↑ cm	€
03622	15	14	44,00
03623	15	21	48,00



## Tablett / Teller

tray / plate  
bandeja / plato  
plateau / assiette

	Ø cm	↑ cm	Farbe / Colour	€
83869	38	2,5		24,70

## Rolltophaube mit verchromtem Kugelgriff

rolltop cover with chrome plated handle  
campana abatible con pomo cromado  
cloche basculante avec bouton chromé

	Ø cm	↑ cm	€
18388	38	20	24,00



## Frischhalte-Haube

cover  
campana  
cloche

	Ø cm	↑ cm	€
06510	30	11,5	5,90

mit verchromtem Griff / with chrom plated handle / con botón cromado / avec bouton chromé

	Ø cm	↑ cm	€
06512	30	11,5	8,20

# CASUAL



## Schälchen „CASUAL MINI“

bowl  
cuenco  
bol mini



	cm	↑ cm	ltr.	Farbe / Colour	€
83880	6,0	2,5	0,02	White	2,10
83881	7,5	3,5	0,05	White	2,60



## Schale „CASUAL MAXI“

bowl  
cuenco  
bol



	Ø cm	↑ cm	ltr.	Farbe / Colour	€
83696	10	4,5	0,15	White	3,50
83698	12	5,5	0,25	White	4,20
83700	14	6,5	0,50	White	4,90
83704	20	9,2	1,80	White	10,40
83702	23	10,5	2,50	White	11,80

	Ø cm	↑ cm	ltr.	Farbe / Colour	€
83697	10	4,5	0,15	Black	3,50
83699	12	5,5	0,25	Black	4,20
83701	14	6,5	0,50	Black	4,90
83705	20	9,2	1,80	Black	10,40
83703	23	10,5	2,50	Black	11,80



## Schale „CASUAL“

bowl  
cuenco  
bol



	cm	↑ cm	ltr.	€
84221	26,5 x 10,5	6,5	1,0	11,80



83605 Ø 8 cm

passend zu Schalen Ø 7,5 cm  
fits to bowls Ø 7,5 cm



83606 Ø 14,5 cm

passend zu Schalen Ø 14 cm  
fits to bowls Ø 14 cm



83607 Ø 20,5 cm

passend zu Schalen Ø 20 cm  
fits to bowls Ø 20 cm

### Deckel „CASUAL“, 5er Set

cover, 5 pcs.

tapa, set de 5

couvercle, set de 5

Hygienischer Schutz für Ihre Speisen

dichtschließend, schwappsicherer Transport

protection for your food

tightly closing, slosh-proof transport

protección de alimentos, con cierre hermético, transporte sin salpicaduras

protection des aliments

fermeture hermétique, transport sans éclaboussures



	Ø cm	↑ cm	fits to	pcs.	€/ set
83605	8,0	0,5	11866, 83881, 15400, 15416, 15461, 15462, 15467, 40655, 40656	5	3,60
83606	14,5	0,5	11865, 83700, 83701, 85104, 85105, 85107	5	6,00
83607	20,5	0,5	83704, 83705, 15404, 15420	5	7,00



stapelbar  
stackable



84215



84216

### Schale „CASUAL“

bowl

cuenco

bol



	Ø cm	↑ cm	ltr.	Farbe / Colour	€
84215	10	6,5 / 8,5	0,2	—	5,90
84216	12	7,5 / 9,5	0,3	—	7,50



### Schale „CASUAL“

bowl

cuenco

bol



	Ø cm	↑ cm	ltr.	Farbe / Colour	€
84295	10	7	0,13	—	3,40



### Dipschale „CASUAL“

dip tray

bandeja para dips

plateau pour dips



	cm	↑ cm	Farbe / Colour	€
84220	29 x 9	3	—	8,00



83782



83798



83777

### Dipschälchen „CASUAL“

dip bowl

cuenco para dip

ramequin



	Ø cm	↑ cm	ltr.	Farbe / Colour	VE / unit	€/ pc.
83780	6,0	4,0	0,05	—	24	1,20
83781	7,5	4,0	0,07	—	24	1,50
83782	8,0	4,5	0,08	—	24	1,90
83783	8,5	4,5	0,12	—	24	2,00
83798	6,0	4,0	0,05	—	24	1,40
83777	6,0	3,5	0,04	—	24	1,40



Dipschälchen „FLOWER POT“

dip bowl  
cuenco para dip  
ramequin



	Ø cm	↑ cm	ltr.	Farbe / Colour	VE / unit	€ / pc.
84470	6,0	3,5	0,04		60	1,80
84471	6,0	3,5	0,04		60	1,80
84472	6,0	3,5	0,04		60	1,80



Dipschälchen, 6er Set

dip bowl, 6 pcs.  
cuenco para dip, set de 6  
ramequin, set de 6



	Ø cm	↑ cm	ltr.	Farbe / Colour	pcs.	€ / set
85240	6	4	0,04		6	10,40
85241	6	4	0,04		6	10,40
85242	6	4	0,04		6	10,40
85243	6	4	0,04		6	10,40
85244	6	4	0,04		6	10,40



Schale „MINI“

bowl  
cuenco  
bol



	cm	↑ cm	ltr.	Farbe / Colour	VE / unit	€ / pc.
84750	8 x 8	3	0,06		24	3,50



**Teller „MINI“**

plate  
plato  
assiette



	cm	↑ cm	ltr.	VE / unit	€ / pc.
84444	10,5 x 8,5	2,0	0,07	20	3,70



**Schale „MINI“**

bowl  
cuenco  
bol



	cm	↑ cm	ltr.	VE / unit	€ / pc.
84445	10,5 x 6,0	4,0	0,07	20	3,70
84446	13,5 x 7,5	3,0	0,07	20	3,70
84448	9,5 x 9,0	5,5	0,09	20	3,70
84449	13,0 x 12,0	7,5	0,18	20	5,00



**Schale „MINI“**

bowl  
cuenco  
bol



	cm	↑ cm	ltr.	VE / unit	€ / pc.
84452	11,5 x 7,5	3,0	0,06	24	2,10
84454	11,5 x 6,0	5,5	0,04	24	2,10
84456	8,5 x 7,0	6,0	0,07	24	2,10
84458	8,0 x 8,0	4,0	0,10	24	2,10
84450	7,5 x 7,0	4,5	0,05	24	2,10



Schale „MINI“  
bowl  
cuenco  
bol



	Ø cm	↑ cm	ltr.	VE / unit	Farbe / Colour	€ / pc.
84775	8,5	2,5	0,07	60		3,20
84778	8,5	2,5	0,07	60		3,20
84781	8,5	2,5	0,07	60		3,20



Schale „MINI“  
bowl  
cuenco  
bol



	Ø cm	↑ cm	ltr.	VE / unit	Farbe / Colour	€ / pc.
84776	8,5	2,5	0,07	48		3,20
84779	8,5	2,5	0,07	48		3,20
84782	8,5	2,5	0,07	48		3,20



Schale „MINI“  
bowl  
cuenco  
bol



	cm	↑ cm	ltr.	VE / unit	Farbe / Colour	€ / pc.
84777	9,5 x 5,5	5,5	0,07	48		3,20
84780	9,5 x 5,5	5,5	0,07	48		3,20
84783	9,5 x 5,5	5,5	0,07	48		3,20



Schale „HALFTONE“  
bowl  
cuenco  
bol



	Ø cm	↑ cm	ltr.	VE / unit	€ / pc.
84217	8,0	4,0	0,1	12	4,00



Dipschälchen „GOURMET“  
dip bowl  
cuenco para dip  
ramequin



	Ø cm	↑ cm	ltr.	VE / unit	€ / pc.
84018	7	6	0,05	20	2,60

# FLYING BUFFET



## Fingerfood-Teller „FLYING BUFFET“

fingerfood plate  
plato para el aperitivo  
assiette pour apéritif



	cm	↑ cm	Farbe / Colour	VE / unit	€ / pc.
83878	9,5 x 9,5	1,5 / 3,5		24	4,00
83879	9,5 x 9,5	1,5 / 3,5		24	4,00



## Schale „FLOAT“

bowl  
cuenco  
bol



	cm	↑ cm	Farbe / Colour	€
83912	9 x 9	4,5		3,60
83913	9 x 9	4,5		3,60



GN 1/1

## GN Tablett „APART“

GN tray  
GN bandeja  
GN plateau



	cm	↑ cm	GN	€
83828	53 x 32,5	2,5	1/1	38,50
83830	32,5 x 26,5	2,5	1/2	21,40



GN 1/1

GN Edelstahl Tablett  
GN stainless steel platter  
GN bandeja de acero inoxidable  
GN plateau en acier inox



	cm	GN	€
11119	53 x 32,5	1/1	33,00

# FINGERFOODLÖFFEL



**Fingerfoodlöffel „HALFTONE“**  
party spoon  
cuchara party  
cuillère party



	∅ cm	↑ cm	VE / unit	€ / pc.
84158	5,5	7	24	3,70



**Fingerfoodlöffel „HALFTONE“**  
party spoon  
cuchara party  
cuillère party



	cm	↑ cm	VE / unit	€ / pc.
84128	14,5 x 4,5	4,5	12	3,70



**Fingerfoodlöffel „LEAF“**  
party spoon  
cuchara party  
cuillère party



	cm	↑ cm	Farbe / Colour	VE / unit	€ / pc.
83889	10 x 4,5	1,5		50	2,20
83887	10 x 4,5	1,5		50	2,20
83888	10 x 4,5	1,5		50	2,20







## Fingerfoodlöffel „HONG KONG“

party spoon  
cuchara party  
cuillère party



	cm	↑ cm	Farbe / Colour	VE / unit	€ / pc.
83486	13 x 4,5	4,5		60	1,50
83487	13 x 4,5	4,5		60	1,50



## Fingerfoodlöffel „MING HING“

party spoon  
cuchara party  
cuillère party



	cm	↑ cm	Farbe / Colour	VE / unit	€ / pc.
83842	11 x 4,5	4		60	1,40
83843	11 x 4,5	4		60	1,40



## Schale „MINI“

bowl  
cuenco  
bol



	cm	↑ cm	ltr.	VE / unit	€ / pc.
84460	35 x 4,5	3	0,20	10	3,30



## Schale, rund „TAO“

bowl, round  
cuenco, redondo  
bol, rond



	cm	↑ cm	ltr.	Farbe / Colour	€
83648	10,5 x 10,0	6,5 / 3,0	0,07		4,20
83649	10,5 x 10,0	6,5 / 3,0	0,07		4,20

## CUTLERY REST



**Besteckablage „SMALL WAVE“**  
cutlery rest  
reposa cuchara  
pose-cuillère



	cm	↑ cm		€
83897	26 x 13	4,5		10,90



**Besteckablage „BOWL“**  
cutlery rest  
reposa cuchara  
pose-cuillère



	cm	↑ cm	ltr.	€
83803	22,5 x 11	6	0,5	7,80



**Besteckablage „SPOON“**  
cutlery rest  
reposa cuchara  
pose-cuillère



	cm	↑ cm		€
83801	26 x 10,5	5		7,40



**Servierlöffel „PROFI“**  
serving spoon  
cuchara para servir  
cuillère de service



	cm	→ cm	Farbe / Colour	€
84020	7 x 6,5	26,5	White	5,80
84021	7 x 6,5	26,5	Black	5,80



**Salatlöffel**  
salad spoon  
cuchara para ensalada  
cuillère à salade



	cm	→ cm		€
84035	8 x 7	24		2,40



**Eierbecher, 4er Set**  
egg holder, 4 pcs. set  
huevera, set de 4  
coquetier, set de 4



	Ø cm	↑ cm	pcs.	Farbe / Colour	€ / set
83849 <small>NEW</small>	8,5	2	4	Black	7,60
83848	8,5	2	4	White	7,60



**Eierbecher, 4er Set**  
egg holder, 4 pcs. set  
huevera, set de 4  
coquetier, set de 4



	Ø cm	↑ cm	pcs.	€ / set
83851	8	3	4	8,00



**GN-Behälter „ECOLINE“**

GN container  
GN cubeta  
GN bac

mit Stapelnocke

with notching edge

con borde marcado para el apilado

avec rebord pour l'empilage



	GN	↓ mm	ltr.	cm	Farbe / Colour	€
83759	1/1	65	7,10	53,0 x 32,5		32,60
83755	2/4	65	3,00	53,0 x 16,2		22,00
83757	1/2	65	3,40	32,5 x 26,5		18,60
83753	1/3	65	2,00	32,5 x 17,6		16,00
83751	1/4	65	1,35	26,5 x 16,2		14,20
83749	1/6	65	0,80	17,6 x 16,2		11,20

	GN	↓ mm	ltr.	cm	Farbe / Colour	€
83758	1/1	65	7,10	53,0 x 32,5		32,60
83754	2/4	65	3,00	53,0 x 16,2		22,00
83756	1/2	65	3,40	32,5 x 26,5		18,60
83752	1/3	65	2,00	32,5 x 17,6		16,00
83750	1/4	65	1,35	26,5 x 16,2		14,20
83748	1/6	65	0,80	17,6 x 16,2		11,20

	GN	↓ mm	ltr.	cm	Farbe / Colour	€
84300	1/1	100	10,6	53,0 x 32,5		38,00
84302	2/4	100	4,3	53,0 x 16,2		27,40
84301	1/2	100	4,7	32,5 x 26,5		22,60
84303	1/3	100	2,7	32,5 x 17,6		18,40
84304	1/4	100	1,9	26,5 x 16,2		16,00
84305	1/6	100	1,0	17,6 x 16,2		12,20

	GN	↓ mm	ltr.	cm	Farbe / Colour	€
84306	1/1	100	10,6	53,0 x 32,5		38,00
84308	2/4	100	4,3	53,0 x 16,2		27,40
84307	1/2	100	4,7	32,5 x 26,5		22,60
84309	1/3	100	2,7	32,5 x 17,6		18,40
84310	1/4	100	1,9	26,5 x 16,2		16,00
84311	1/6	100	1,0	17,6 x 16,2		12,20



**GN-Deckel**

GN-lid

GN tapa

GN couvercle



	GN	cm	€
82001	1/1	53,0 x 32,5	11,60
82013	1/2	32,5 x 26,5	6,70
82019	1/3	32,5 x 17,6	5,30
82029	1/4	26,5 x 16,2	4,30
82037	1/6	17,6 x 16,2	3,30





# Tableware & Table Presentation

TAKASHI .....	254
LEVANTE .....	256
SNACKHOLDERS .....	262
ENAMELWARE .....	266
CAST IRON .....	268
DIP BOWLS .....	270
PEBBLES .....	272
PARTY SPOONS .....	273
WECK .....	274
BOWLS   WOOD .....	280
SERVING BOARDS   WOOD .....	282
SERVING BOARDS   NATURAL SLATE .....	288
MANGO .....	290
TRAYS .....	292
SEAFOOD .....	293
MENAGES .....	294
SALT- / PEPPER MILLS .....	302
TABLE CADDYS .....	311
BUTTER DISHES   EGG HOLDERS .....	312
GRAVY BOATS .....	314
FONDUE   CAVIAR COOLER .....	317
PLACEMATS .....	318
SUGAR DISPENSERS .....	329
TABLE LAMPS .....	336
DECORATION .....	342
MENU HOLDERS .....	343
CUTLERY BINS .....	350
WASTE BINS .....	354

NEW

TAKASHI



- Made in Japan
- handgefertigt
- schwere Qualität
- made in Japan
- handcrafted
- heavy quality
- fabricado en Japón
- artesanal
- alta calidad
- fabriqué au Japon
- artisanal
- haute qualité

NEW



**Teller / Sushiboard „TAKASHI“**

plate / sushiboard  
plato para sushi  
assiette sushi



Glas, transparent / glass, transparent / cristal, transparente / verre, transparent

	cm	↑ cm	VE / unit	€ / pc.
40900	19 x 6,5	1,5	3	11,00

NEW



**Teller / Sushiboard „TAKASHI“**

plate / sushiboard  
plato para sushi  
assiette sushi



Glas, transparent / glass, transparent / cristal, transparente / verre, transparent

	cm	↑ cm	VE / unit	€ / pc.
40902	26 x 13	1,5	3	18,00

NEW



**Teller / Sushiboard „TAKASHI“**

plate / sushiboard  
plato para sushi  
assiette sushi



Glas, transparent / glass, transparent / cristal, transparente / verre, transparent

	cm	↑ cm	VE / unit	€ / pc.
40904	23 x 18	1,5	3	21,00

NEW



**Teller / Sushiboard „TAKASHI“**

plate / sushiboard  
plato para sushi  
assiette sushi



Glas, transparent / glass, transparent / cristal, transparente / verre, transparent

	cm	↑ cm	VE / unit	€ / pc.
40906	29,5 x 15,5	1,5	1	24,00



- Made in Japan
- handgefertigt
- schwere Qualität
- made in Japan
- handcrafted
- heavy quality
- fabricado en Japón
- artesanal
- alta calidad
- fabriqué au Japon
- artisanal
- haute qualité



NEW

**Teller / Sushiboard „TAKASHI“**

plate / sushiboard  
plato para sushi  
assiette sushi



Glas, french grey / glass, french grey / cristal, french grey / verre, french grey

	cm	↑ cm	VE / unit	€ / pc.
40901	19 x 6,5	1,5	3	11,00



NEW

**Teller / Sushiboard „TAKASHI“**

plate / sushiboard  
plato para sushi  
assiette sushi



Glas, french grey / glass, french grey / cristal, french grey / verre, french grey

	cm	↑ cm	VE / unit	€ / pc.
40903	26 x 13	1,5	3	18,00



NEW

**Teller / Sushiboard „TAKASHI“**

plate / sushiboard  
plato para sushi  
assiette sushi



Glas, french grey / glass, french grey / cristal, french grey / verre, french grey

	cm	↑ cm	VE / unit	€ / pc.
40905	23 x 18	1,5	3	21,00



NEW

**Teller / Sushiboard „TAKASHI“**

plate / sushiboard  
plato para sushi  
assiette sushi



Glas, french grey / glass, french grey / cristal, french grey / verre, french grey

	cm	↑ cm	VE / unit	€ / pc.
40907	29,5 x 15,5	1,5	1	24,00

# LEVANTE



Levante Küche passend serviert! Viel Gemüse, wenig Fleisch und eine Vielfalt an Gewürzen charakterisieren die Küche des Nahen Ostens. Der östliche Mittelmeerraum, also Syrien, Libanon, Jordanien, Israel und Palästina wird als Levante bezeichnet. Als Levante-Küche wird die Essenstradition dieser Länder als Food-Trend gefeiert.

Levantine cuisine served appropriately! Lots of vegetables, little meat and a variety of spices characterise the cuisine of the Middle East. The eastern Mediterranean region, i. e. Syria, Lebanon, Jordan, Israel and Palestine is referred to as the Levant. As Levantine cuisine, the food tradition of these countries is celebrated as a food trend.

Cocina levantina servida como es debido. Mucha verdura, poca carne y una gran variedad de especias caracterizan la cocina de Oriente Medio. La región del Mediterráneo oriental, es decir, Siria, Líbano, Jordania, Israel y Palestina, se denomina Levante. La cocina levantina, la tradición alimentaria de estos países, se celebra como una tendencia alimentaria.

Cuisine levantine servie comme il se doit! Beaucoup de légumes, peu de viande et une variété d'épices caractérisent la cuisine du Moyen-Orient. La région de la Méditerranée orientale, c'est-à-dire la Syrie, le Liban, la Jordanie, Israël et la Palestine, est appelée le Levant. La tradition alimentaire de ces pays, la cuisine levantine, est célébrée comme une tendance alimentaire.



## Flaschenkühler „LEVANTE“

bottle cooler  
enfriador de botella  
rafraîchisseur de bouteille

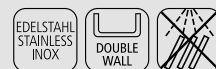

doppelwandig für beste Isolierung, für 0,7 - 1,5 Liter-Flaschen

double wall cooler keeps the temperature for a long time, for 0,7 - 1,5 ltr. bottles

doble pared para mantener el frío largo tiempo, para botellas de 0,7 - 1,5 ltr.

double paroi pour une meilleure conservation de la température, pour bouteilles de 0,7 à 1,5 l.

	cm	↑ cm	Farbe / Colour	€
36125	12 / 10	20		24,00
36127	12 / 10	20		24,00



## Tablett „LEVANTE“

tray  
bandeja  
GN plateau



	cm	↑ cm	ltr.	Farbe / Colour	€
40712	26,5 x 16	3	0,70		16,00
40713	26,5 x 16	3	0,70		16,00



Präsentationsmöglichkeit  
presentation example





Schale „LEVANTE“

bowl  
cuenco  
bol



	Ø cm	↑ cm	ltr.	Farbe / Colour	€
40700	9,5	4,5	0,14		8,00
40701	9,5	4,5	0,14		8,00
40702	12	6,5	0,32		12,40
40703	12	6,5	0,32		12,40
40704	17	8,5	0,90		19,00
40705	17	8,5	0,90		19,00



stapelbar  
stackable

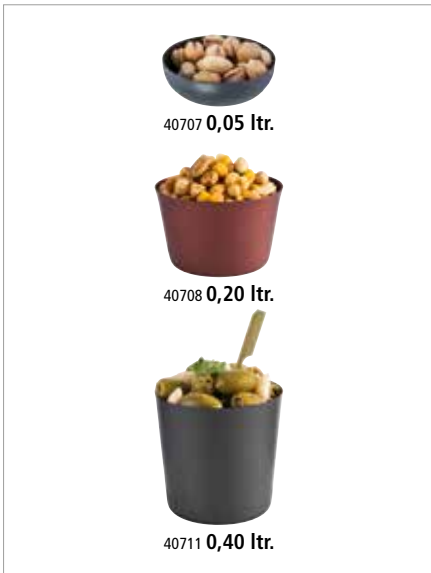

Schale „LEVANTE“

bowl  
cuenco  
bol



	Ø cm	↑ cm	ltr.	Farbe / Colour	€
40706	7,5	2,5	0,05		4,90
40707	7,5	2,5	0,05		4,90
40708	8,5	5,5	0,20		7,40
40709	8,5	5,5	0,20		7,40
40710	8,5	8,5	0,40		8,00
40711	8,5	8,5	0,40		8,00



40706

Präsentationsmöglichkeit  
presentation example



Dipschälchen, 6er Set „LEVANTE“

dip bowl, 6 pcs.  
cuenco para dip, set de 6  
ramequin, set de 6



	Ø cm	↑ cm	ltr.	Farbe / Colour	pcs.	€ / set
40722	6,0	2,5	0,04		6	15,00
40723	6,0	2,5	0,04		6	15,00



40723

00754

Präsentationsmöglichkeit  
presentation example



Dipschälchen, 6er Set „LEVANTE“

dip bowl, 6 pcs.  
cuenco para dip, set de 6  
ramequin, set de 6



	Ø cm	↑ cm	ltr.	Farbe / Colour	pcs.	€ / set
40726	6,0	4,5	0,06		6	16,00
40727	6,0	4,5	0,06		6	16,00

**NEW** SNACKHOLDER

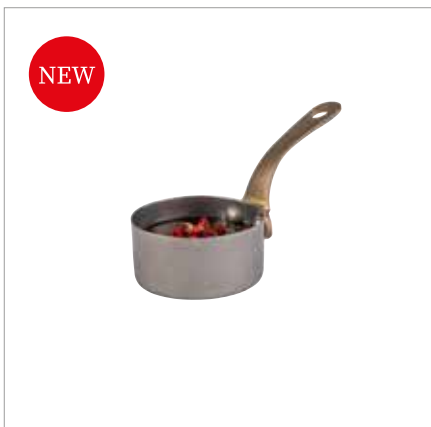

NEW

**Stielkasserolle / Serviertopf**  
 saucepan / serving pot  
 cacerola / olla  
 casserole à manche / marmite  
**Antik-Edelstahl-Look**  
 antique stainless steel look  
 acero inoxidable look antiguo  
 look acier inox antique



	Ø cm	↑ cm	ltr.	Griff / handle cm	€
40780	5,5	2,5	0,05	5	7,20



NEW

**Stielkasserolle / Serviertopf**  
 saucepan / serving pot  
 cacerola / olla  
 casserole à manche / marmite  
**Antik-Edelstahl-Look**  
 antique stainless steel look  
 acero inoxidable look antiguo  
 look acier inox antique



	Ø cm	↑ cm	ltr.	Griff / handle cm	€
40781	7	3,5	0,12	7,5	12,00

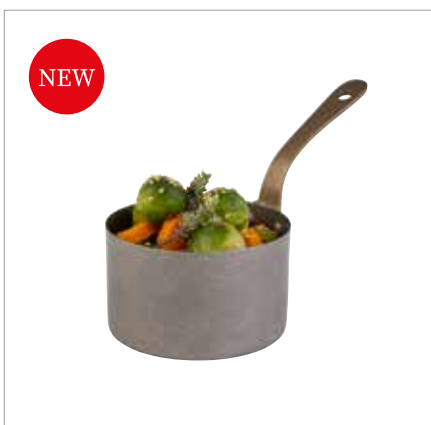

NEW

**Stielkasserolle / Serviertopf**  
 saucepan / serving pot  
 cacerola / olla  
 casserole à manche / marmite  
**Antik-Edelstahl-Look**  
 antique stainless steel look  
 acero inoxidable look antiguo  
 look acier inox antique



	Ø cm	↑ cm	ltr.	Griff / handle cm	€
40782	9,5	5,5	0,3	7	16,00

NEW



**Stielkasserolle / Serviertopf**

saucepan / serving pot  
cacerola / olla  
casserole à manche / marmite

**Antik-Edelstahl-Look**

antique stainless steel look  
acero inoxidable look antiguo  
look acier inox antique



	Ø cm	↑ cm	ltr.	Griff / handle cm	€
40783	14	4	0,4	10	18,00

NEW



**Stielkasserolle / Serviertopf**

saucepan / serving pot  
cacerola / olla  
casserole à manche / marmite

**Antik-Edelstahl-Look**

antique stainless steel look  
acero inoxidable look antiguo  
look acier inox antique



	Ø cm	↑ cm	ltr.	Griff / handle cm	€
40784	18,5	4,5	0,9	10,5	21,00

NEW



**Serviertopf**

serving pot  
olla  
marmite

**Antik-Edelstahl-Look**

antique stainless steel look  
acero inoxidable look antiguo  
look acier inox antique



	Ø cm	↑ cm	ltr.	Griff / handle cm	€
40785	11,5	5	0,35	2	17,00

NEW



**Serviertopf**

serving pot  
olla  
marmite

**Antik-Edelstahl-Look**

antique stainless steel look  
acero inoxidable look antiguo  
look acier inox antique



	Ø cm	↑ cm	ltr.	Griff / handle cm	€
40786	14	5	0,55	2	19,00



# MUMBAI



## Serviertöpfchen „MUMBAI“

small serving pot  
olla pequeña de servir  
marmite petite de servir



**Edelstahl, außen: Kupfer-Look, gehämmerte Oberfläche, Griffe vergoldet**  
stainless steel, outside: copper look, hammered surface, handles gold-plated  
acero inoxidable, exterior: look cobre, superficie martillada, asas doradas  
acier inox, extérieur: look cuivre, surface martelée, poignées dorées

	Ø cm	↑ cm	ltr.	Griff / handle cm	€
40730	9,0	5,5	0,30	2,25	14,40
40731	11,5	4,5	0,35	2,00	14,40
40732	11,5	7,0	0,60	2,25	16,50
40733	14,0	5,0	0,50	1,75	15,40
40734	16,0	5,0	0,70	1,75	16,50



## Mini-Servierpfanne „MUMBAI“

small serving pan  
olla pequeña de servir  
marmite petite de servir



**Edelstahl, außen: Kupfer-Look, gehämmerte Oberfläche, Griffe vergoldet**  
stainless steel, outside: copper look, hammered surface, handles gold-plated  
acero inoxidable, exterior: look cobre, superficie martillada, asas doradas  
acier inox, extérieur: look cuivre, surface martelée, poignées dorées

	cm	↑ cm	ltr.	Griff / handle cm	€
40735	12,5 x 8,5	4,0	0,25	2,0	15,40
40736	14,5 x 9,5	4,5	0,45	2,0	16,50



## Schale „MUMBAI“

bowl  
cuenco  
bol



**Edelstahl, außen: Kupfer-Look, gehämmerte Oberfläche, Griffe vergoldet**  
stainless steel, outside: copper look, hammered surface, handles gold-plated  
acero inoxidable, exterior: look cobre, superficie martillada, asas doradas  
acier inox, extérieur: look cuivre, surface martelée, poignées dorées

	Ø cm	↑ cm	ltr.	€
40737	8,5	4,5	0,15	6,40
40738	9,0	5,0	0,20	7,80



40740 0,6 ltr.



40741 0,3 ltr.



40742 0,5 ltr.

**Serviertöpfchen**  
small serving pot  
olla pequeña de servir  
marmite petite de servir

**Aluminium anthrazit, Griffe aus Messing**  
aluminium anthracite, brass handles  
aluminio antracita, asas de latón  
aluminium anthracite, poignées en laiton



	Ø cm	↑ cm	ltr.	Griff / handle cm	€
40740	11,5	9,5	0,6	2,5	26,00
40741	13,5	5,0	0,3	3,5	24,00
40742	15,0	6,0	0,5	2,5	25,00



**Mini-Servierpfanne „SNACKHOLDER“**  
mini pan  
sartén en formato mini  
poêle à frire mini



	cm	↑ cm	ltr.	€
40660	14,5 x 9,5	4,5 / 6,5	0,5	10,00



40186 0,30 ltr.



40187 0,55 ltr.



40188 0,75 ltr.

**Serviertöpfchen „MUMBAI“**

small serving pot  
olla pequeña de servir  
marmite petite de servir

**gehämmerte Oberfläche**  
hammered surface  
superficie martillada  
surface martelée



	Ø cm	↑ cm	ltr.	Griff / handle cm	€
40186	9,5	5,5	0,30	2,5	8,60
40187	13,5	5,0	0,55	3,0	9,80
40188	15,5	5,0	0,75	3,0	11,60



40642 0,05 ltr.

40643 0,12 ltr.

40644 0,32 ltr.

**Stielkasserolle / Serviertopf**

sauté pan / mini sauce pan  
cazo recto bajo  
plat à sauter

**hochglanzpoliert**  
mirror polished  
pulido brillante  
poli brillant



	Ø cm	↑ cm	ltr.	Griff / handle cm	€
40642	5,5	2,5	0,05	6	4,90
40643	7,0	3,5	0,12	8,5	5,50
40644	9,5	5,5	0,32	8,5	8,70

# SNACKHOLDER



Die Mini-Edelstahlkörbchen dienen dem portionsweisen Servieren. Zum originellen Servieren von Beilagen geeignet.

The mini frying baskets are used to present individual portions in an original way.

Las mini cestas para freír se utilizan para presentar las porciones individuales de forma original.

Les paniers à friture offrent une présentation originale pour servir apéritifs, snacks, tapas et autres rations individuelles.



## Servier-Frittierkorb „SNACKHOLDER“

stainless steel fry baskets  
cestitas inox para el servicio mesa  
paniers inox pour le service sur table



	Ø cm	↑ cm	Griff / handle cm	Farbe / Colour		€
40600	8	7,5	9,5		stainless steel	9,00
40602	8	7,5	9,5		copper	11,40
40624	8	7,5	9,5		black mat	11,40
40601	9	8,5	9,0		stainless steel	11,20
40603	9	8,5	9,0		copper	13,00
40625	9	8,5	9,0		black mat	13,60



## Servier-Frittierkorb „SNACKHOLDER“

stainless steel fry baskets  
cestitas inox para el servicio mesa  
paniers inox pour le service sur table



	cm	↑ cm	Griff / handle cm	Farbe / Colour		€
40610	21,5 x 10,5	4,5	9,5		stainless steel	15,00
40612	21,5 x 10,5	4,5	9,5		copper	17,60
40628	21,5 x 10,5	4,5	9,5		black mat	17,60
40611	26,0 x 13,0	5,0	9,0		stainless steel	17,60
40613	26,0 x 13,0	5,0	9,0		copper	20,40
40629	26,0 x 13,0	5,0	9,0		black mat	20,40



## Servier-Frittierkorb „SNACKHOLDER“

stainless steel fry baskets  
cestitas inox para el servicio mesa  
paniers inox pour le service sur table



	cm	↑ cm	Griff / handle cm	Farbe / Colour		€
40620	10,0 x 8,5	6,5	9,0		stainless steel	12,00
40622	10,0 x 8,5	6,5	9,0		copper	15,80
40626	10,0 x 8,5	6,5	9,0		black mat	15,80
40621	13,0 x 10,5	9,0	13,5		stainless steel	15,80
40623	13,0 x 10,5	9,0	13,5		copper	19,40
40627	13,0 x 10,5	9,0	13,5		black mat	19,40



**Snackholder**  
serving cup  
vaso para servir  
gobelet à apéritif



	Ø cm	↑ cm	ltr.	Farbe / Colour	€
40606	8,5	8,5	0,35	stainless steel	4,20
40617	8,5	8,5	0,35	stainless copper	4,80
40607	8,5	8,5	0,35	hammered surface	4,60
40618	8,5	8,5	0,35	hammered surface	5,40
40605	9,5	8,5 / 11,5	0,45	stainless steel	5,80
40616	9,5	8,5 / 11,5	0,45	stainless copper	6,50



**Schale „LEVANTE“**  
bowl  
cuenco  
bol



	Ø cm	↑ cm	ltr.	Farbe / Colour	€
40710	8,5	8,5	0,40	red	8,00
40711	8,5	8,5	0,40	dark grey	8,00



**Servier- / Saucen-Eimer „SNACKHOLDER“**

mini stainless steel bucket  
cubo inox en formato mini  
seau mini inox  
hochglanzpoliert  
mirror polished  
pulido brillante  
poli brillant



	Ø cm	↑ cm	ltr.	pcs.	€
40630	7	6,5	0,15	4	13,40
40631	9	8,5	0,33	1	4,80



**Mini-Milchkanne „SNACKHOLDER“ 4er Set**

mini milk can, 4 pcs.  
lechera en formato mini, set de 4  
pot à lait mini, set de 4



	Ø cm	↑ cm	ltr.	pcs.	€ / set
40640	4,5	5	0,08	4	16,40

## SNACKHOLDERS



40654 0,12 ltr.

40656 0,35 ltr.

40659 0,80 ltr.

40657 1,30 ltr.

40658 1,80 ltr.

### Snackcan

serving can  
lata para aperitivos  
boîte de conserves pour apéritifs

**matt poliert**  
matt polished  
pulido mate  
poli mat



	Ø cm	↑ cm	ltr.		€
40654	6,5	4,0	0,12	ideale Beilagen Größe	2,70
40655	7,5	5,5	0,17		3,20
40656	7,5	10,0	0,35		4,00
40659	12,0	8,0	0,80		7,40
40658	13,5	14,0	1,80		9,90
40657	13,5	10,5	1,30		9,00

Wachspapier „SNACKHOLDER“ / greaseproof paper squares  
papel alimenticio para cucurucho / papier alimentaire pour cornet

	cm	pcs.		€ / set
40670	42 x 25	500	Motiv: Zeitung	59,00



Präsentationsmöglichkeit  
presentation example



40685 0,05 ltr.

40686 0,17 ltr.

### Schale

bowl  
cuenco  
bol  
**hochglanzpoliert**  
mirror polished  
pulido brillante  
poli brillant



	Ø cm	↑ cm	ltr.	€
40685	6	3,0	0,05	2,40
40686	8	4,5	0,17	3,60



0,15 ltr.

### Schale "MUMBAI"

bowl  
cuenco  
bol  
**gehämmerte Oberfläche**  
hammered surface  
superficie martillada  
surface martelée



	Ø cm	↑ cm	ltr.	€
40185	9,5	3	0,15	4,00





40690 0,7 ltr.



40691 0,7 ltr.



40692 0,7 ltr.



40693 1,4 ltr.



40694 1,4 ltr.



40695 1,4 ltr.

Schale  
bowl  
cuenco  
bol

gehämmerte Oberfläche  
hammered surface  
superficie martillada  
surface martelée



	Ø cm	↑ cm	ltr.	Farbe / Colour	€
40690	15,5 x 12,0	5,5	0,7	gold look	14,00
40691	15,5 x 12,0	5,5	0,7	copper look	14,00
40692	15,5 x 12,0	5,5	0,7	gunmetal-look	14,00
40693	23,0 x 15,5	6,0	1,4	gold look	21,00
40694	23,0 x 15,5	6,0	1,4	copper look	21,00
40695	23,0 x 15,5	6,0	1,4	gunmetal-look	21,00



Präsentationsmöglichkeit  
presentation example



40604

Servierkorb „BURGER & FRIES“

serving basket  
cesta para servir  
corbeille de service

Servierkorb aus Metall mit 2 Haltern für Dipschälchen

metal serving basket with 2 holders for dip bowls

cesta de metal para servir con 2 soportes para cuencos para dip

corbeille de service en métal avec 2 supports pour ramequins



	cm	↑ cm	€
40604	39,5 x 20	11	10,00

passende Schälchen / suitable bowls / cuencos adecuados / bols  
appropriés



	Ø cm	↑ cm	ltr.	VE / unit	€ / pc.
83781	7,5	4	0,07	24	1,50



83781

Servierbeispiel - Lieferung ohne Schälchen  
delivery without bowls



Präsentationsmöglichkeit  
presentation example

# ENAMELWARE



Henkelbecher „ENAMELWARE“  
beaker  
vaso coctelero  
bol mélangeur



	Ø cm	↑ cm	ltr.	Farbe / Colour	€
40636	7	5	0,10		6,00
40632	9	8	0,35		7,20
40637	10	9	0,50		8,60



Schale „ENAMELWARE“  
bowl  
cuenco  
bol



	Ø cm	↑ cm	ltr.	Farbe / Colour	€
40645	7,0	4,5	0,08		4,90
40646	8,0	3,5	0,08		4,90
40638	13,0	6,0	0,50		7,40
40647	16,5	4,5	0,45		6,20



**Teller, flach „ENAMELWARE“**

plate, flat  
plato, plano  
assiette, plat



	Ø cm	↑ cm	Farbe / Colour	€
40664	20	2		6,60
40665	24	2		7,80
40666	26	2		7,90



**Teller, tief „ENAMELWARE“**

plate, deep  
plato, profunda  
assiette, profonde



	Ø cm	↑ cm	ltr.	Farbe / Colour	€
40661	18	3,5	0,35		8,00
40662	22	3,5	0,60		8,80
40663	24	3,5	0,85		9,80



**Schale „ENAMELWARE“**

bowl  
cuenco  
bol



	cm	↑ cm	ltr.	Farbe / Colour	€
40667	16 x 12,0	3,5	0,20		7,90
40668	18 x 13,5	4,0	0,35		8,60



**Schale „ENAMELWARE“**

bowl  
cuenco  
bol



	cm	↑ cm	ltr.	Farbe / Colour	€
40669	28 x 23	4,5	1,9		14,20





# CAST IRON

Die Servierpfännchen aus emailiertem Gusseisen dienen dem portionsweisen Servieren und halten die Speisen warm.

The serving pans made of enameled cast iron are used for serving in portions and for keeping the food warm.

Las fuentes de hierro fundido esmaltado se utilizan para servir en porciones y mantener la comida caliente.

Les plateaux de service en fonte émaillée sont utilisés pour servir en portions et garder les aliments au chaud.



## Servierpfännchen „CAST IRON“

serving pan  
fuente para servir  
plat de service

Gusseisen emailiert  
enameled cast iron  
hierro fundido esmaltado  
fonte émaillée



	∅ cm	↑ cm	Farbe / Colour	€
88220	10	2		11,40
88225	10	2		11,40
88221	13	2		12,40
88226	13	2		12,40



## Servierpfännchen „CAST IRON“

serving pan  
fuente para servir  
plat de service

Gusseisen emailiert  
enameled cast iron  
hierro fundido esmaltado  
fonte émaillée



	cm	↑ cm	Farbe / Colour	€
88222	13 x 13	2		12,40
88227	13 x 13	2		12,40
88223	16 x 13	2		14,00
88228	16 x 13	2		14,00
88224	20 x 13	2		16,00
88229	20 x 13	2		16,00



## SERVING TROWELS



40680

40681

**Servierkelle „BOB“**

serving trowel  
paleta para servir  
truelle de service



**Edelstahl Servierkelle mit schwarzem Holzgriff**

stainless steel serving trowel with black wooden handle  
paleta para servir de acero inoxidable con mango de madera negra  
truelle de service en acier inox avec manche en bois noir

	cm	↑ cm	Griff / handle cm		€
40680	23,5 x 15,5	12,5	13,5	stainless steel	16,90
40681	23,5 x 15,5	12,5	13,5	■	16,90

**Snackbox „INDUSTRIAL“**

snack box  
caja tentempié  
casse-croûte

**Metall, schwarz**

metal, black  
metal, negro  
métal, noir



	cm	↑ cm	ltr.	€
40676	23,0 x 15,5	13,0	2,4	15,20



stapelbar  
stackable

# DIP BOWLS



Ob Nachos mit Käsedip, Gemüsesticks mit Joghurtsoße oder eine Käseplatte mit Feigensenf: All diese Köstlichkeiten finden in Dipschalen ihren Platz und regen den Appetit Ihrer Gäste an.

Whether nachos with cheese dip, vegetable sticks with yoghurt sauce or cheese platter with fig mustard: all these delicacies find their place in dip bowls and stimulate the appetite of your guests.

Ya sean nachos con dip de queso, palitos de verdura con salsa de yogur o tabla de quesos con mostaza de higos: todas estas delicias encuentran su lugar en los cuencos para dip y estimulan el apetito de sus invitados.

Qu'il s'agisse de nachos avec trempette au fromage, de bâtonnets de légumes avec sauce au yaourt ou d'un plateau de fromage avec moutarde aux figues : tous ces délices trouvent leur place dans les bols à trempette et stimulent l'appétit de vos invités.

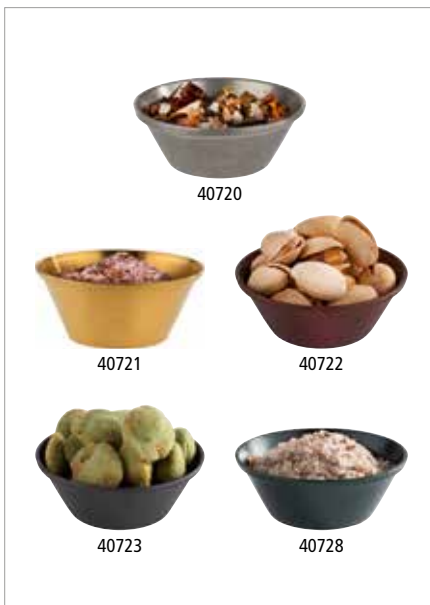

## Dipschälchen, 6er Set

dip bowl, 6 pcs.  
cuenco para dip, set de 6  
ramequin, set de 6



	Ø cm	↑ cm	ltr.	Farbe / Colour	pcs.	€ / set
40720	6,0	2,5	0,04		6	16,60
40721	6,0	2,5	0,04		6	20,80
40722	6,0	2,5	0,04		6	15,00
40723	6,0	2,5	0,04		6	15,00
40728	6,0	2,5	0,04		6	15,50



Präsentationsmöglichkeit  
presentation example



## Dipschälchen, 6er Set

dip bowl, 6 pcs.  
cuenco para dip, set de 6  
ramequin, set de 6



	Ø cm	↑ cm	ltr.	Farbe / Colour	pcs.	€ / set
40724	6,0	4,5	0,06		6	17,80
40725	6,0	4,5	0,06		6	22,00
40726	6,0	4,5	0,06		6	16,00
40727	6,0	4,5	0,06		6	16,00
40729	6,0	4,5	0,06		6	16,60



**Dipschälchen, 12er Set**  
dip bowl, 12 pcs.  
cuenco para dip, set de 12  
ramequin, set de 12



	Ø cm	↑ cm	ltr.	Farbe / Colour	pcs.	€ / set
40760	6,0	3,5	0,04	—	12	12,00
40761	6,0	3,5	0,04	—	12	12,00
40762	6,0	3,5	0,04	—	12	12,00
40763	7,0	3,5	0,07	—	12	14,00
40764	7,0	3,5	0,07	—	12	14,00
40765	7,0	3,5	0,07	—	12	14,00
40766	7,5	4,0	0,09	—	12	16,00
40767	7,5	4,0	0,09	—	12	16,00
40768	7,5	4,0	0,09	—	12	16,00



**Dipschälchen, 6er Set**  
dip bowl, 6 pcs.  
cuenco para dip, set de 6  
ramequin, set de 6



	Ø cm	↑ cm	ltr.	Farbe / Colour	pcs.	€ / set
85240	6,0	4,0	0,04	—	6	10,40
85241	6,0	4,0	0,04	—	6	10,40
85242	6,0	4,0	0,04	—	6	10,40
85243	6,0	4,0	0,04	—	6	10,40
85244	6,0	4,0	0,04	—	6	10,40



**Dipschälchen „FLOWER POT“**  
dip bowl  
cuenco para dip  
ramequin



	Ø cm	↑ cm	ltr.	Farbe / Colour	VE / unit	€ / pc.
84470	6,0	3,5	0,04	—	60	1,80
84471	6,0	3,5	0,04	—	60	1,80
84472	6,0	3,5	0,04	—	60	1,80



**Dipschälchen „CASUAL“**  
dip bowl  
cuenco para dip  
ramequin



	Ø cm	↑ cm	ltr.	Farbe / Colour	VE / unit	€ / pc.
83780	6,0	4,0	0,04	—	24	1,20
83781	7,5	4,0	0,07	—	24	1,50
83782	8,0	4,5	0,08	—	24	1,90
83783	8,5	4,5	0,12	—	24	2,00
83798	6,0	4,0	0,04	—	24	1,40
83777	6,0	3,5	0,03	—	24	1,40



**Dipschälchen „GOURMET“**  
dip bowl  
cuenco para dip  
ramequin

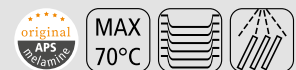

	Ø cm	↑ cm	ltr.	Farbe / Colour	VE / unit	€ / pc.
84018	7,0	6,0	0,05	—	20	2,60



NEW

# PEBBLES

NEW



40790



40791

## Schale, 4er Set „PEBBLES“

bowl, 4 pcs.  
cuenco, set de 4  
bol, set de 4



	cm	↑ cm	Farbe / Colour	pcs.	€/ set
40790	6,5 x 6	2,5	copper look	4	18,00
40791	6,5 x 6	2,5	gunmetal look	4	18,00



PVD-beschichteter Edelstahl  
PVD coated stainless steel

stapelbar  
stackable

NEW



40792



40793

## Teller, 4er Set „PEBBLES“

plate, 4 pcs.  
plato, set de 4  
assiette, set de 4



	cm	↑ cm	Farbe / Colour	pcs.	€/ set
40792	8,5 x 8	1	copper look	4	18,00
40793	8,5 x 8	1	gunmetal look	4	18,00

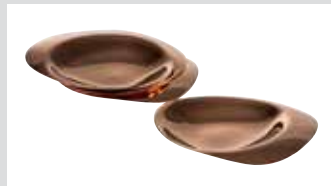

PVD-beschichteter Edelstahl  
PVD coated stainless steel

stapelbar  
stackable

NEW



40794



40795

## Teller, 4er Set „PEBBLES“

plate, 4 pcs.  
plato, set de 4  
assiette, set de 4



	cm	↑ cm	Farbe / Colour	pcs.	€/ set
40794	9 x 9	1	copper look	4	18,00
40795	9 x 9	1	gunmetal look	4	18,00



PVD-beschichteter Edelstahl  
PVD coated stainless steel

stapelbar  
stackable



**Gourmetlöffel/-gabel, 6er Set**

tapas spoon / fork, 6 pcs.  
cuchara / tenedor de tapas, set de 6  
cuillère / fourchette à tapas, set de 6

**Verwendung als Löffel oder Gabel möglich**

can be used as a spoon or fork  
puede utilizarse como cuchara o tenedor  
peut être utilisé comme une cuillère ou une fourchette



	→ cm	pcs.	€ / set
00699	10	6	8,60

**Gourmetlöffel „CLASSIC“**

party spoon  
cuchara gourmet  
cuillère gourmet

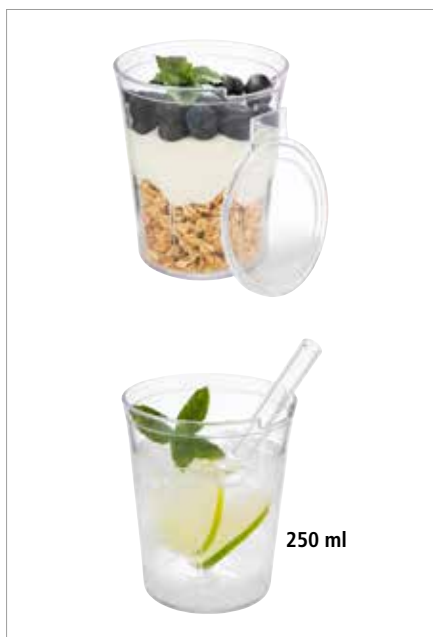

	→ cm			€
00693	12,0	gunmetal look	PVD coated stainless steel	5,70
00677	13,5	stainless steel look		2,80
00691	12,0	gold look	PVD coated stainless steel	5,70
00692	12,0	copper look	PVD coated stainless steel	5,70

**Becher Set „SUPER CUP“, 8er Set**

barrel mug set, 8 pcs.  
vasos, set de 8  
gobelets, set de 8

**Set bestehend aus 8 Bechern + 8 Deckeln**

set consists of 8 barrel mugs + 8 lids  
set compuesto por 8 vasos + 8 tapas  
set composé de 8 gobelets + 8 couvercles



**IDEAL  
FÜR  
„TAKE AWAY“**

	Ø cm	↑ cm	ltr.	pcs.	€ / set
10506	8	10	0,25	8	19,00



mit Stapelnocke  
with stacking cam

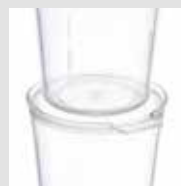

rutschfester Deckel  
non-slip lid

**Snackspender**

snack dispenser  
dispensador de snacks  
distributeur de snacks

**Behälter aus Glas, Schraubdeckel aus Edelstahl, Öffnung oval 3,5 x 2,5 cm**

glass container, stainless steel screw cap, opening oval 3,5 x 2,5 cm  
recipiente de cristal, tapón de rosca de acero inoxidable, apertura ovalada 3,5 x 2,5 cm  
récipient en verre, couvercle à visser en acier inox, ouverture ovale 3,5 x 2,5 cm



	Ø cm	↑ cm	ltr.	Farbe / Colour	€
40516	8,5	15,5	0,35		8,40
40517	8,5	15,5	0,35		8,40

# Original WECK



## Weck-Flaschen, 6er Set

Weck-bottles, 6 pcs.  
Weck-botellas, set de 6  
Weck-bouteilles, set de 6



**6 Flaschen + 6 Deckel, ideal zum Servieren von Saft, Smoothie, Dressing und Saucen**

6 bottles + 6 covers, ideal for serving juice, smoothie, dressing and sauces

6 botellas + 6 tapas, ideal para servir zumo, licuado, aliño y salsas

6 bouteilles + 6 couvercles, idéal pour servir de jus, smoothie, vinaigrette et sauces

	Ø cm	↑ cm	ltr.	pcs	€/ set
82307	6	14,5	0,25	6	13,50



## Weck-Flaschen, 6er Set

Weck-bottles, 6 pcs.  
Weck-botellas, set de 6  
Weck-bouteilles, set de 6



**6 Flaschen + 6 Deckel, ideal zum Servieren von Saft, Smoothie, Dressing und Saucen**

6 bottles + 6 covers, ideal for serving juice, smoothie, dressing and sauces

6 botellas + 6 tapas, ideal para servir zumo, licuado, aliño y salsas

6 bouteilles + 6 couvercles, idéal pour servir de jus, smoothie, vinaigrette et sauces

	Ø cm	↑ cm	ltr.	pcs	€/ set
82308	6	19	0,5	6	15,00



## Weck-Flaschen, 6er Set

Weck-bottles, 6 pcs.  
Weck-botellas, set de 6  
Weck-bouteilles, set de 6



**6 Flaschen + 6 Deckel, ideal zum Servieren von Saft, Smoothie, Dressing und Saucen**

6 bottles + 6 covers, ideal for serving juice, smoothie, dressing and sauces

6 botellas + 6 tapas, ideal para servir zumo, licuado, aliño y salsas

6 bouteilles + 6 couvercles, idéal pour servir de jus, smoothie, vinaigrette et sauces

	Ø cm	↑ cm	ltr.	pcs	€/ set
82309	6	25,5	1,0	6	18,00



**Edelstahldeckel für Weck-Gläser**  
 stainless steel lid for Weck-glasses  
 tapas de acero inoxidable por Weck tarros  
 couvercles en acier inox pour Weck verrines



	Ø cm	↑ cm		€
82360	10,5	2	82346, 82347	6,00



**Weck-Gläser mit Deckel, 2er Set**  
 Weck-glasses with lid, 2 pcs.  
 Weck tarros de vidrio con tapa, set de 2  
 Weck verrines avec couvercle, set de 2

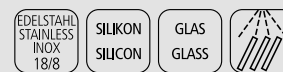

**2 Gläser + 2 klappbare Edelstahldeckel**  
 2 glasses + 2 foldable stainless steel lids  
 2 tarros + 2 tapas plegables de acero inoxidable  
 2 verrines + 2 couvercles pliables en acier inox

	Ø cm	↑ cm	ltr.	pcs	€ / set
82241	11	7,5	0,37	2	18,00
82242	11	11	0,58	2	21,60



**klappbarer Edelstahldeckel für Weck-Gläser**  
 foldable stainless steel lid for Weck-glasses  
 tapa plegable de acero inoxidable por Weck tarros  
 couvercle pliable en acier inox pour Weck verrines



	Ø cm	↑ cm		€
82361	10,5	4,5	82241, 82242, 82346, 82347	7,10



**Holzdeckel für Weck-Gläser**  
 wooden lid for Weck-glasses  
 tapas de madera por Weck tarros  
 couvercles en bois pour Weck verrines



	Ø cm	↑ cm	fits to	€
82362	11	2	82346, 82347	4,90



**Holzdeckel für Weck-Gläser, 12er Set**  
 wooden lid for Weck-glasses, 12 pcs.  
 tapas de madera para Weck tarros, set de 12  
 couvercles en bois pour Weck verrines, set de 12



	Ø cm	↑ cm	fits to	pcs.	€ / set
82363	7	1,5	82307, 82308, 82309, 82310, 82312, 82314, 82316, 82370, 82371	12	30,00



**Weck-Gläser mit Deckel, 12er Set**

Weck-glasses with lid, 12 pcs.  
 Weck tarros de vidrio con tapa, set de 12  
 Weck verrines avec couvercle, set de 12



**12 Gläser + 12 Deckel**

12 glasses + 12 covers  
 12 vasos + 12 tapas  
 12 verrines + 12 couvercles

	Ø cm	↑ cm	ltr.	pcs	€/ set
82310	6	5,5	0,08	12	22,70
82312	6	7,0	0,14	12	24,80
82314	6	8,0	0,16	12	24,80
82345	9	6	0,20	12	27,60

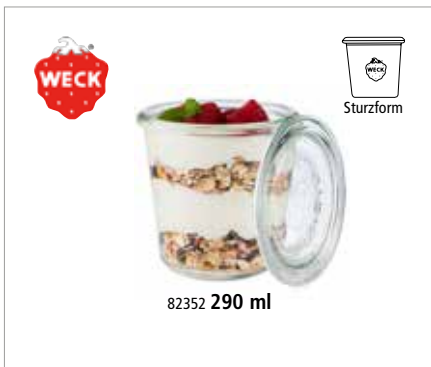

**Weck-Gläser mit Deckel, 6er Set**

Weck-glasses with lid, 6 pcs.  
 Weck tarros de vidrio con tapa, set de 6  
 Weck verrines avec couvercle, set de 6



**6 Gläser + 6 Deckel**

6 glasses + 6 covers  
 6 tarros + 6 tapas  
 6 verrines + 6 couvercles

	Ø cm	↑ cm	ltr.	pcs	€/ set
82352	9	9	0,29	6	13,50



**Weck-Gläser mit Deckel, 3er Set**

Weck-glasses with lid, 3 pcs.  
 Weck tarros de vidrio con tapa, set de 3  
 Weck verrines avec couvercle, set de 3



**3 Gläser + 3 Deckel**

3 glasses + 3 covers  
 3 vasos + 3 tapas  
 3 verrines + 3 couvercles

	Ø cm	↑ cm	ltr.	pcs	€/ set
82346	11	7,5	0,37	3	7,60



**Weck-Gläser mit Deckel, 2er Set**

Weck-glasses with lid, 2 pcs.  
 Weck tarros de vidrio con tapa, set de 2  
 Weck verrines avec couvercle, set de 2



**2 Gläser + 2 Deckel**

2 glasses + 2 covers  
 2 vasos + 2 tapas  
 2 verrines + 2 couvercles

	Ø cm	↑ cm	ltr.	pcs	€/ set
82347	11	11	0,58	2	6,70



82350 75 ml

82316 220 ml

**Weck-Gläser mit Deckel, 12er Set**

Weck-glasses with lid, 12 pcs.

Weck tarros de vidrio con tapa, set de 12

Weck verrines avec couvercle, set de 12

**12 Gläser + 12 Deckel**

12 glasses + 12 covers

12 vasos + 12 tapas

12 verrines + 12 couvercles



	Ø cm	↑ cm	ltr.	pcs	€ / set
82350	5,5	6	0,075	12	20,40
82316	7	8,0	0,22	12	24,80



82354 580 ml

**Weck-Gläser mit Deckel, 6er Set**

Weck-glasses with lid, 6 pcs.

Weck tarros de vidrio con tapa, set de 6

Weck verrines avec couvercle, set de 6

**6 Gläser + 6 Deckel**

6 glasses + 6 covers

6 tarros + 6 tapas

6 verrines + 6 couvercles



	Ø cm	↑ cm	ltr.	pcs	€ / set
82354	11	9	0,58	6	15,90



82359 35 ml

82371 160 ml

**Gourmetgläser, 12er Set**

gourmet glasses, 12 pcs.

tarros gourmet, set de 12

verres gourmet, set de 12



	Ø cm	↑ cm	ltr.	pcs	€ / set
82359	5	3,5	0,035	12	10,20
82370	6	5,5	0,08	12	13,80
82371	6	8,0	0,16	12	14,80

**12er Set, ohne Deckel**

12 pcs., without covers



**Serviergestell „WECK“**

serving stand  
expositor  
présentoir  
ohne Gläser  
without glasses  
sin vasos  
sans verrines



	Ø cm	↑ cm		€
33246	22	59	12 x Ø 6 cm	94,00

passende Gläser / matching glasses / vasos a juego / verrines approprié



	Ø cm	↑ cm	ltr.	pcs	€ / set
82310	6	5,5	0,08	12	22,70
82312	6	7,0	0,14	12	24,80
82314	6	8,0	0,16	12	24,80



**Weck-Frischhaltedeckel, 5er Set**

airtight cover, 5 pcs.  
tapa hermética, set de 5  
couvercle hermétique, set de 5  
für Rundrandgläser Ø 6 cm, 5er Set  
for Ø 6 cm glasses, 5 pcs. set  
para vasos Ø 6 cm, set de 5  
pour verrines Ø 6 cm, set de 5



	Ø cm		pcs.	€ / set
82338	7		5	2,45



**Gummidichtringe, 10er Set**

rubber washer, 10 pcs.  
juntas de goma, set de 10  
joints de caoutchouc, set de 10  
für Deckel der Weck-Gläser, im Beutel verpackt

for covers of Weck-glasses, packed in a bag  
para las tapas de los tarritos Weck, empaquetado en una bolsa  
pour la fermeture des verrines Weck, emballé dans un sac



	fits to		pcs.	€ / set
82318	82307, 82308, 82309, 82310, 82312, 82314, 82316		10	1,30
82394	82345		10	1,30
82395	82346, 82347		10	1,40



**8er Set Deckel-Klammer für 4 Weck-Gläser**

8 pcs. cover clamps for 4 Weck-glasses  
8 abrazaderas para 4 vasitos Weck  
8 agrafes pour 4 verrines Weck



		pcs.	€ / set
82319		8	2,20

NEW TWINZ



NEW



### Gläser, 2er Set „TWINZ“

glasses, 2 pcs. set  
vasos, set de 2  
verres, set de 2

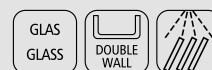

**doppelwandig, ideal für kleine Speisen und Desserts oder Espresso**  
glass, double-walled, ideal for small dishes and desserts or espresso  
vidrio, doble pared, ideal para platos pequeños y postres o espresso  
verre, à double paroi, idéal pour les petits plats et les desserts ou espresso

	Ø cm	↑ cm	ltr.	pcs.	€/ set
10370	6	6,5	0,08	2	8,00

NEW



### Gläser, 2er Set „TWINZ“

glasses, 2 pcs. set  
vasos, set de 2  
verres, set de 2

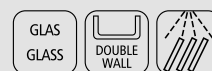

**doppelwandig, ideal für kleine Speisen und Desserts oder Kaffee**  
glass, double-walled, ideal for small dishes and desserts or coffee  
vidrio, doble pared, ideal para platos pequeños y postres o café  
verre, à double paroi, idéal pour les petits plats et les desserts ou le café

	Ø cm	↑ cm	ltr.	pcs.	€/ set
10371	8,5	8,5	0,23	2	10,00

NEW



### Gläser, 2er Set „TWINZ“

glasses, 2 pcs. set  
vasos, set de 2  
verres, set de 2

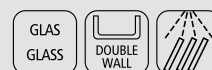

**doppelwandig, ideal für kleine Speisen und Desserts oder Latte Macchiato**  
glass, double-walled, ideal for small dishes and desserts or latte macchiato  
vidrio, doble pared, ideal para platos pequeños y postres o latte macchiato  
verre, à double paroi, idéal pour les petits plats et les desserts ou le latte macchiato

	Ø cm	↑ cm	ltr.	pcs.	€/ set
10372	8,5	14	0,38	2	12,00



**Schale, 4er Set „OLIVE“**

bowl, 4 pcs.  
cuenco, set de 4  
bol, set de 4



aus geöltem Olivenholz, naturbedingte Abweichung in Form, Maserung und Größe

oiled olive wood, natural deviation in shape, grain and size

de madera de olivo aceitada, diferencias naturales posibles en forma, grano y tamaño  
en bois d'olivier huilé, éventuelles différences naturelles de forme, de grain et de taille

	∅ cm	↑ cm	ltr.	pcs.	€/ set
01024	6	2	0,03	4	14,00



**Schale, 2er Set „OLIVE“**

bowl, 2 pcs.  
cuenco, set de 4  
bol, set de 4



aus geöltem Olivenholz, naturbedingte Abweichung in Form, Maserung und Größe

oiled olive wood, natural deviation in shape, grain and size

de madera de olivo aceitada, diferencias naturales posibles en forma, grano y tamaño  
en bois d'olivier huilé, éventuelles différences naturelles de forme, de grain et de taille

	cm	↑ cm	ltr.	pcs.	€/ set
01025	12,5 x 8	2,5	0,05	2	10,00



01010 0,15 ltr.

01011 0,25 ltr.

01012 0,50 ltr.

**Schale „OLIVE“**

bowl  
cuenco  
bol



aus geöltem Olivenholz, naturbedingte Abweichung in Form, Maserung und Größe

oiled olive wood, natural deviation in shape, grain and size

de madera de olivo aceitada, diferencias naturales posibles en forma, grano y tamaño  
en bois d'olivier huilé, éventuelles différences naturelles de forme, de grain et de taille

	∅ cm	↑ cm	ltr.	€
01010	10,0	4,0	0,15	10,00
01011	12,5	4,5	0,25	13,80
01012	15,0	6,0	0,50	20,00



3 Größen ineinander  
3 sizes in each other



00843 0,05 ltr.

00844 0,10 ltr.

**Schale „OLIVE“**

bowl  
cuenco  
bol



aus geöltem Olivenholz, naturbedingte Abweichung in Form, Maserung und Größe

oiled olive wood, natural deviation in shape, grain and size

de madera de olivo aceitada, diferencias naturales posibles en forma, grano y tamaño  
en bois d'olivier huilé, éventuelles différences naturelles de forme, de grain et de taille

	cm	↑ cm	ltr.	€
00843	12,0 x 7,5	2,5	0,05	7,80
00844	16,5 x 9,5	2,5	0,10	10,00





Schale „OLIVE“

bowl  
cuenco  
bol

aus geöltem Olivenholz  
oiled olive wood  
de madera de olivo aceitada  
en bois d'olivier huilé



	cm	↑ cm	ltr.	€
00907	13 x 8	6,5	0,2	6,60
00908	16 x 9	7,0	0,3	10,00
01023	25 x 8,5	7,5	0,4	18,00



Schale „OLIVE“

bowl  
cuenco  
bol

aus geöltem Olivenholz, naturbedingte Abweichung in Form, Maserung und Größe  
oiled olive wood, natural deviation in shape, grain and size  
de madera de olivo aceitada, diferencias naturales posibles en forma, grano y tamaño  
en bois d'olivier huilé, éventuelles différences naturelles de forme, de grain et de taille

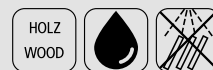

	cm	↑ cm	ltr.	€
01013	7,5 x 7,5	2,5	0,05	5,00
01014	17,5 x 8,5	2,5	0,15	12,40
01015	26,5 x 11,5	5,0	0,60	19,00



Servierbrett „OLIVE“

serving board  
tabla de servir  
planche de service

aus geöltem Olivenholz, naturbedingte Abweichung in Form, Maserung und Größe  
oiled olive wood, natural deviation in shape, grain and size  
de madera de olivo aceitada, diferencias naturales posibles en forma, grano y tamaño  
en bois d'olivier huilé, éventuelles différences naturelles de forme, de grain et de taille



	cm	↑ cm	€
01022	39,5 x 21	2,5	32,00
01021	35,5 x 18,5	2,0	24,00



mit Safrille  
with juice groove



Servierbrett „OLIVE“

serving board  
tabla de servir  
planche de service

aus geöltem Olivenholz, naturbedingte Abweichung in Form, Maserung und Größe  
oiled olive wood, natural deviation in shape, grain and size  
de madera de olivo aceitada, diferencias naturales posibles en forma, grano y tamaño  
en bois d'olivier huilé, éventuelles différences naturelles de forme, de grain et de taille



	cm	↑ cm	€
00905	25,5 x 16,5	1,5	12,00
00906	35,0 x 20,5	1,5	22,00



**Servierbrett „OLIVE“**

servicing board  
tabla de servir  
planche de service



aus geöltem Olivenholz, mit 19 mm Aufhäng Bohrung, naturbedingte Abweichung in Form, Maserung und Größe

oiled olive wood, natural deviation in shape, grain and size  
de madera de olivo aceitada, diferencias naturales posibles en forma, grano y tamaño

en bois d'olivier huilé, éventuelles différences naturelles de forme, de grain et de taille

	cm	↑ cm	Griff / handle cm	€
00870	25,0 x 17,0	1,5	-	32,00
00871	30,0 x 20,5	2,0	-	52,00
00875	19,0 x 12,5	1,5	6	23,00
00876	25,0 x 16,0	1,5	8	35,00
00877	31,0 x 20,0	1,5	9	52,00
00873	40,0 x 15,0	1,5	11	56,00
00874	44,0 x 20,0	2,0	12	72,00



**SNACKBOX „OLIVE“**

snackbox  
caja tentempié  
casse-croûte



aus geöltem Olivenholz

oiled olive wood

de madera de olivo aceitada

en bois d'olivier huilé

	cm	↑ cm	€
01016	22 x 15	6	21,00
01017	25 x 18	6	29,00



**Tablett**

tray  
bandeja  
plateau



aus Bambus, geeignet zum Servieren und Transportieren

made of bamboo, suitable for serving and transport

de bambú, para servir y transportar

en bambou, pour servir et transporter

	cm	↑ cm	GN	€
00845	32,5 x 26,5	3	1/2	13,00
00846	32,5 x 17,6	3	1/3	9,80



Präsentationsmöglichkeit  
presentation example

**Servierbrett „NARROW II“**

serving board  
tabla de servir  
planche de service

**Akazienholz, mit 3 Aussparungen Ø 6 cm**

acacia wood, with 3 notches Ø 6 cm  
madera de acacia, con 3 ranuras Ø 6 cm  
bois d'acacia, avec 3 encoches Ø 6 cm



	cm	↑ cm	€
00878	31 x 11	2	11,20

**passende Schälchen / suitable bowls /**  
cuencos adecuados / bols apropiés



	Ø cm	↑ cm	litr.		€
40686	8	4,5	0,17	stainless steel	3,60
82316	7	8	0,22	glass / 12 pcs.	24,80
85080	8	7,5	0,05	melamine / 3 pcs.	34,00
85081	8	7,5	0,05	melamine / 3 pcs.	34,00

**Holzbox „TABLE“**

woodbox  
caja madera  
base bois

**Akazienholz, 3 Fächer (6,5 x 6,5 cm)**

acacia wood, 3 compartments (6,5 x 6,5 cm)  
madera de acacia, 3 compartimentos (6,5 x 6,5 cm)  
bois d'acacia, 3 compartiments (6,5 x 6,5 cm)



	cm	↑ cm	inner size cm	€
11727	23,5 x 8,5	4,5	6,5 x 6,5 je Fach / each compartment	12,90

**Holzbox „TABLE“**

woodbox  
caja madera  
base bois

**Akazienholz, natur**

acacia wood, nature  
madera de acacia, natural  
bois d'acacia, naturel



	cm	↑ cm	inner size cm	€
11726	15 x 9,5	5	12 x 6,5	9,90

**Serviertablett**

serving tray  
bandeja para servir  
plateau de service

**aus geöltem Eichenholz, mit 2 Griffmulden**

made of oiled oak wood, with 2 recessed handles  
de madera de roble aceitada, con 2 asas empotradas  
en bois de chêne huilé, avec 2 poignées encastrées



	cm	↑ cm	€
00761	45 x 35	6	44,00

## SERVING BOARDS | WOOD



### Servierbrett „SHARING“

serving board  
tabla de servir  
planche de service



Servierbrett aus geöltem Akazienholz

serving board made of oiled acacia wood  
tabla de servir de madera de acacia aceitada  
planche en bois d'acacia huilé

	cm	↑ cm	Griff / handle cm	€
00887	51,5 x 18	1,5	8,5	33,00



2 tlg.  
2 pcs.

mit Aussparung Ø 5 cm  
with hole Ø 5 cm

### Servierbrett

serving board  
tabla de servir  
planche de service



2-teilig: 1 Holzbrett aus Akazienholz + 1 Naturschieferplatte

2 pcs.: 1 wood board made of acacia wood + 1 natural slate tray  
set de 2: 1 tabla de madera de acacia + 1 bandeja de pizarra natural  
set de 2: 1 planche en bois d'acacia + 1 plat ardoise naturelle

	cm	↑ cm	€ / set
00814	28 x 17,5	2	16,00



2 tlg.  
2 pcs.

### Servierbrett

serving board  
tabla de servir  
planche de service



2-teilig: 1 Holzbrett aus Akazienholz + 1 Naturschieferplatte

2 pcs.: 1 wood board made of acacia wood + 1 natural slate tray  
set de 2: 1 tabla de madera de acacia + 1 bandeja de pizarra natural  
set de 2: 1 planche en bois d'acacia + 1 plat ardoise naturelle

	cm	↑ cm	Griff / handle cm	€ / set
00810	26 x 18	2	8	15,00
00811	33 x 20	2	8	18,40
00812	40 x 15	2	5	23,40
00813	43 x 12	2	12	18,40

Präsentationsmöglichkeit  
presentation example



mit Hängeloch Ø 2 cm / with a handle-hole Ø 2 cm



### Servierbrett „AKAZIE-SCHIEFER“

serving board  
tabla de servir  
planche de service



raffiniertes, rustikales Servierbrett aus Akazienholz,

ausgestattet mit einem Naturschieferstreifen zur Kennzeichnung  
wood with slate, markable

madera con pizarra, se puede marcar

bois avec ardoise, on peut mettre une inscription

	cm	↑ cm	Griff / handle cm	€
00867	30,5 x 13	1,5	10	18,00
00868	36,5 x 15	1,5	12	23,00
00869	42,0 x 18	1,5	14	26,00

**Servierbrett**

serving board  
tabla de servir  
planche de service



aus geöltem Akazienholz / made of oiled acacia wood / de madera de acacia aceitada / en bois d'acacia huilé

	cm	↑ cm	€
00793	25 x 17	1,5	13,00

**Servierbrett**

serving board  
tabla de servir  
planche de service



aus geöltem Akazienholz / made of oiled acacia wood / de madera de acacia aceitada / en bois d'acacia huilé

	cm	↑ cm	€
00897	30 x 15	2	13,60
00898	30 x 18	2	16,00
00899	35 x 25	2	22,40

**Servierbrett**

serving board  
tabla de servir  
planche de service



aus geöltem Akazienholz / made of oiled acacia wood / de madera de acacia aceitada / en bois d'acacia huilé

	cm	↑ cm	€
00792	37 x 8	2	10,80

**Servierschale**

serving bowl  
cuenca de servir  
bol de service



aus geöltem Akazienholz / made of oiled acacia wood / de madera de acacia aceitada / en bois d'acacia huilé

	cm	↑ cm	€
00790	16,5 x 9	2	10,00
00791	23,5 x 13	2	12,00

**Servierbrett „NARROW I“**

serving board  
tabla de servir  
planche de service



Akazienholz, mit 3 Vertiefungen Ø 4 cm / acacia wood, with 3 notches Ø 4 cm  
madera de acacia, con 3 ranuras Ø 4 cm / bois d'acacia, avec 3 encoches Ø 4 cm

	cm	↑ cm	€
00864	22 x 8	1,5	9,90

**Servierbeispiel - Lieferung ohne Gläser**  
delivery without glasses

passende Schälchen / fitting bowls / cuencos adecuados / bols appropriés

	Ø cm	↑ cm	litr.		€
82359	5	3,5	0,035	glass / 12 pcs	11,30
82350	6	5,5	0,08	glass / 12 pcs	20,40
40685	6	3,0	0,05	stainless steel	2,40



# SIMPLY WOOD

Eiche, das widerstandsfähigste europäische Holz, ist seit jeher Ausdruck von Qualität, Kraft und Energie.  
Eichen werden uralte und riesengroß, sind unvergleichlich stark und standfest.

Oak, the most resistant European wood, has always been an expression of quality, strength and energy.  
Oaks grow to be ancient and huge, are incomparably strong and stable.

El roble, la madera europea más resistente, siempre ha sido expresión de calidad, fuerza y energía.  
Los robles llegan a ser antiguos y gigantes, son incomparablemente fuertes y estables.

Le chêne, le bois européen le plus résistant, est depuis toujours l'expression de la qualité, de la force et de l'énergie.  
Les chênes deviennent très vieux et gigantesques, ils sont incomparablement forts et stables.



## Servierbrett „SIMPLY WOOD“

servicing board  
tabla de servir  
planche de service



**Eichenholz geölt, mit Aufhängeloch Ø 1,5 cm, mit Lederband**

oak wood oiled, with handle hole Ø 1,5 cm, with leather strap  
madera de roble aceitada, con agujero para colgar Ø 1,5 cm, con correa de cuero  
bois de chêne huilé, avec trou de suspension Ø 1,5 cm, avec ruban en cuir

	cm	↑ cm	→ Griff / handle	€
00750	20 x 20	2	8	25,00
00751	27 x 17	2	8	29,00
00752	32 x 22	2	8	39,00



mit Lederband  
with leather strap



## Tablett / Sushiboard „SIMPLY WOOD“

tray / sushiboard  
bandeja para sushi  
plateau sushi

aus geöltem Eichenholz  
made of oiled oak wood  
de madera de roble aceitada  
en bois de chêne huilé



	cm	↑ cm	€
00753	35 x 17	2	22,00

**GN 1/3 Servierbrett „SIMPLY WOOD“**

GN 1/3 serving board  
GN 1/3 tabla de servir  
GN 1/3 planche de service



**Eichenholz geölt, mit Aussparung Ø 4 cm, mit Safrinne**

oak wood oiled, with notch Ø 4 cm, with juice groove  
madera de roble aceitada, con ranura Ø 4 cm, con ranura para líquidos  
bois de chêne huilé, avec encoche Ø 4 cm, avec rigole

	cm	↑ cm	GN	€
00754	32,5 x 17,6	2	1/3	22,00

**Servierbrett**

serving board  
tabla de servir  
planche de service



**Eichenholz, geölt, 2 Aussparungen Ø 4,5 cm, 1 Aussparung Ø 3 cm, mit 2 Griffmulden**

oak wood oiled, 2 notches Ø 4,5 cm, 1 notch Ø 3 cm, with 2 recessed handles  
madera de roble aceitada, 2 ranuras Ø 4,5 cm, 1 ranura Ø 3 cm, con 2 asas empotradas  
bois de chêne huilé, 2 encoches Ø 4,5 cm, 1 encoche Ø 3 cm, avec 2 poignées encastrées

	cm	↑ cm	€
00835	15 x 9	1,5	10,00

passende Gläser / fitting glasses / tarros de vidrio adecuados / verrines appropriées

	Ø cm	↑ cm	ltr.	pcs	€ / set
82350	5,5	6	0,075	12	20,40

**Servierbrett „PIZZA“**

serving board  
tabla de servir  
planche de service



**Eichenholz geölt, mit Safrinne, mit 2 Griffmulden**

oak wood oiled, with juice groove, with 2 recessed handles  
madera de roble aceitada, con ranura para líquidos, con 2 asas empotradas  
bois de chêne huilé, avec rigole, avec 2 poignées encastrées

	Ø cm	↑ cm	€
00755	24	2	22,00
00756	29	2	26,00
00757	34	2	30,00

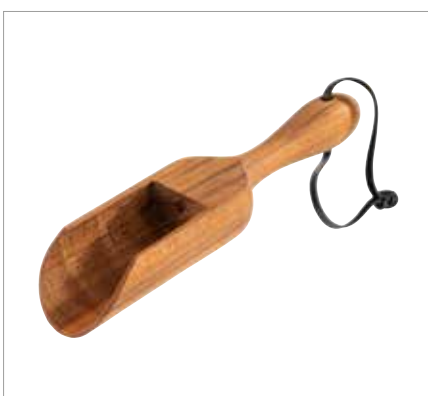
**Schaufel**

scoop  
pala  
pelle



**aus geöltem Eichenholz, ideal für Gewürze, Körner etc.**

made of oiled oak wood, ideal for spices, grains etc.  
de madera de roble aceitada, ideal para especias, granos etc.  
en bois de chêne huilé, idéal pour les épices, céréales, etc.

	cm	↑ cm	€
01026	25,5 x 6	4,5	14,00

## SERVING BOARDS | NATURAL SLATE



### Servierbrett „OAK“

serving board  
tabla de servir  
planche de service

aus geöltem Eichenholz, Safrille, Ø 9,5 cm Aussparung

made of oiled oak, with juice groove, with hole Ø 9.5 cm

de madera de roble aceitada, con ranura para líquidos, con agujero Ø 9,5 cm

en bois chêne huilé, avec rigole, avec trou Ø 9,5 cm



	cm	↑ cm	€
00808	37 x 25	2	29,00



mit Safrille  
with juice groove



### Naturschieferplatte

natural slate tray  
bandeja pizarra natural  
plat ardoise naturelle

mit Safrille, Ø 9,5 cm Aussparung

with juice groove, with hole Ø 9.5 cm

con ranura para líquidos, con agujero Ø 9,5 cm

avec rigole, avec trou Ø 9,5 cm



	cm	* mm	€
00947	33 x 24	6 - 9	10,00



### Naturschieferplatte

natural slate tray  
bandeja pizarra natural  
plat ardoise naturelle

mit Aussparung Ø 6 cm

with hole Ø 6 cm

con agujero Ø 6 cm

avec trou Ø 6 cm



	cm	* mm	€
00986	25 x 12	6 - 9	4,20



### Naturschieferplatte

natural slate tray  
bandeja pizarra natural  
plat ardoise naturelle

mit 3 Aussparungen, Ø 6 cm

with 3 holes, Ø 6 cm

con 3 agujeros, Ø 6 cm

avec 3 trous, Ø 6 cm



	cm	* mm	€
00987	28 x 10	6 - 9	5,80

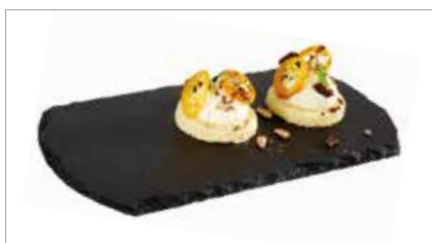

### Naturschieferplatte „STARTER“

natural slate tray  
bandeja de pizarra natural  
plat ardoise naturelle carré



	cm	* mm	€
00937	20 x 10	6 - 9	3,10



Weck-Glas 82316

**Naturschieferplatte / Untersetzer**

natural slate tray  
bandeja de pizarra natural  
plateau ardoise naturelle

mit 2 Aussparungen Ø 6 cm / with 2 holes Ø 6 cm / con 2 agujeros Ø 6 cm / avec 2 trous Ø 6 cm



	cm	✱ mm	€
00971	15 x 8	6 - 9	3,40



00941



00942



00945



00988

**Naturschieferplatte**

natural slate  
bandeja de pizarra natural  
plateau ardoise naturelle

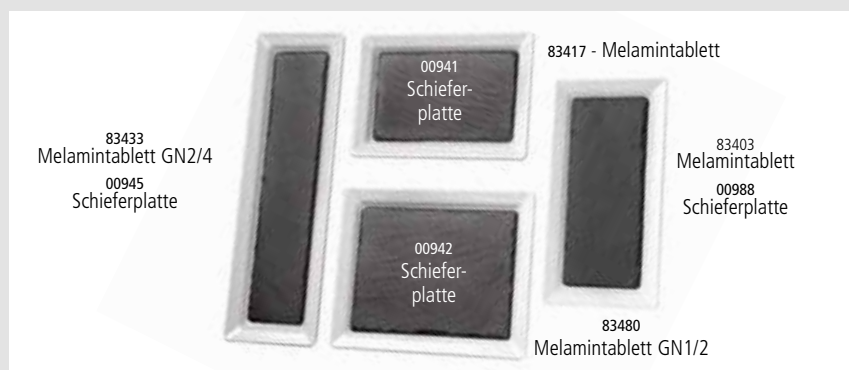

	cm	✱ mm	€
00941	24,0 x 15,0	6 - 9	4,20
00942	26,5 x 20,5	6 - 9	6,40
00945	47,0 x 10,0	6 - 9	6,40
00988	30,0 x 12,0	6 - 9	4,30

**Naturschieferplatte**

natural slate tray  
bandeja de pizarra natural  
plat ardoise naturelle



	cm	✱ mm	€
00996	45 x 30	6 - 9	12,60



00994

**Naturschieferplatte**

natural slate tray  
bandeja de pizarra natural  
plat ardoise naturelle



	cm	✱ mm	€
00994	25 x 25	6 - 9	6,40
00995	30 x 30	6 - 9	9,50

**Naturschieferplatte, 2-teilig**

natural slate tray, 2 pcs. set  
bandeja de pizarra natural, set de 2  
plateau ardoise naturelle, set de 2  
mit Glashaube

with glass cover  
con tapa de cristal  
avec cloche en verre



	Ø cm	↑ cm	✱ mm	€
00984	10,5	8	6 - 9	8,50

**NEW** MANGO



**NEW**



01050



01053



01056



01057

### Schale

bowl  
cuenco  
bol

HOLZ  
WOOD

MAX  
40°C



Mangoholz, Epoxidharz, Motiv (innen): starry sky  
mango wood, epoxy resin, design (inside): starry sky  
madera de mango, resina epoxi, diseño (interior): starry sky  
bois de manguier, résine époxy, design (intérieur): starry sky

	Ø cm	↑ cm	ltr.	€
01050	20	7,5	0,8	18,00
01053	24	7,5	1,1	21,00
01056	30	10,5	3,0	30,00
01057	37	9,0	4,0	30,00



handgefertigt  
handmade

**NEW**



### Tablett / Teller

tray / plate  
bandeja / plato  
plateau / assiette

HOLZ  
WOOD

MAX  
40°C



Mangoholz, Epoxidharz, Motiv (innen): starry sky  
mango wood, epoxy resin, design (inside): starry sky  
madera de mango, resina epoxi, diseño (interior): starry sky  
bois de manguier, résine époxy, design (intérieur): starry sky

	Ø cm	↑ cm	€
01058	35,5	2,5	28,00

**Schale**bowl  
cuenco  
bol

**Mangoholz, Epoxidharz, Motiv (innen): Sicily**  
 mango wood, epoxy resin, design (inside): sicily  
 madera de mango, resina epoxi, diseño (interior): sicily  
 bois de manguier, résine époxy, design (intérieur): sicily

	Ø cm	↑ cm	ltr.	€
01052	24	7,5	1,1	21,00
01055	30	10,5	3,0	30,00

handgefertigt  
handmade**Schale**bowl  
cuenco  
bol

**Mangoholz, Epoxidharz, Motiv (innen): weiß+blau**  
 mango wood, epoxy resin, design (inside): white+blue  
 madera de mango, resina epoxi, diseño (interior): blanco+azul  
 bois de manguier, résine époxy, design (intérieur): blanc+bleu

	Ø cm	↑ cm	ltr.	€
01051	24	7,5	1,1	21,00
01054	30	10,5	3,0	30,00

handgefertigt  
handmade

# TRAYS



## Tablett „VINTAGE“

tray  
bandeja  
plateau

Antik-Edelstahl-Look

stainless steel antique look

acero estilo antiguo

acier style antique



	cm	↑ cm		€
30130	26,0 x 13,5	1,5	rectangular	8,00
30131	34,0 x 18,0	1,5	rectangular	13,20
30134	32,0 x 21,5	2,0	rectangular	15,00
30132	38,0 x 26,5	1,5	rectangular	21,00
30133	25,5 x 16,0	3,0	angular	16,00
30140	20 x 14,5	1,0	oval	5,00
30141	26,5 x 19,5	1,0	oval	7,60
30142	29,0 x 22,0	1,0	oval	9,80

passende Schälchen / fitting bowls / cuencos adecuados / bols apropiés



	Ø cm	↑ cm	litr.	€
40655	7,5	5,5	0,17	3,20
40656	7,5	10	0,35	4,00



S. 264  
page 264



## Tablett „TREND“

baking sheet  
bandeja  
plateau

ein Backblech wird zum Serviertablett

a baking sheet which becomes a serving tray

una bandeja de hornear que se convierte en una bandeja de servir

un moule qui devient un plateau de service



	cm	↑ cm		€
13380	32 x 21,5	2		10,60



## Wachspapier „SNACKHOLDER“

greaseproof paper squares  
papel alimenticio  
papier alimentaire



	cm	pcs.		€
40670	42 x 25	500	Motiv: Zeitung	59,00

2 tlg.  
2 pcs.

85230 Ø 25,5 cm



+



33282

+



85231 Ø 33 cm

**Schale, 2-teilig „FRIDA“**bowl, 2 pcs.  
cuenco, set de 2  
bol, set de 2inklusive Abtropfeinsatz  
including drip tray  
con bandeja recogegotas  
avec égouttoir

	Ø cm	↑ cm	€
85230	25,5	6	27,00
85231	33,0	6	46,00

**Buffetständer**buffet stand  
soporte para buffet  
présentoir buffet

Metall, mit schwarzer Antirutschbeschichtung, für Schalen Nr. 85230, 85231

metal, with black anti-slide coating, for bowls no. 85230, 85231

metal, con revestimiento antideslizante negro, para cuencos 85230, 85231

métal, avec revêtement antidérapant noir, pour bols 85230, 85231

	Ø cm	↑ cm	€
33282	23 / 30,5	17	42,00

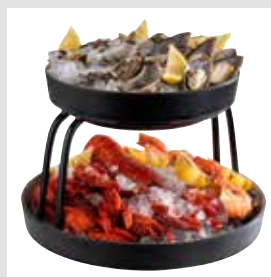
Präsentationsmöglichkeit  
presentation examplemit Abtropfeinsatz  
with drip tray**Servier-Muscheltopf**serving mussel pot  
mejillonera para servir  
casserole à moules pour servir

schwarz emailliertes Stahlblech, mit Edelstahlrand

black enamelled steel, stainless steel rim

hierro esmaltado negro, borde inox

acier émaillé noir, bord inox



	Ø cm	↑ cm	Topf / pot ltr.	Deckel / lid ltr.	€
00623	13,5	9,0	0,75	0,60	10,80
00625	18,0	12,0	2,60	1,40	15,00
00626	20,0	13,0	3,30	1,60	17,00
00627	24,0	13,5	5,20	2,70	20,00

Topf darf nicht erhitzt werden!  
Topf ist nicht zum Kochen geeignet!



# MENAGES



## Menage „WOOD“

menage  
menage  
ménage



**matt poliert, Glasbehälter mit Edelstahldeckel und Deckelverschluss**

matt polished, glass with stainless steel cover  
pulido mate, cristal con tapa de acero inoxidable  
verre et inox poli mat, avec couvercle inox

	cm	↑ cm	€
40435	11,5 x 5,5	17	17,70



## Menage „WOOD“

menage  
menage  
ménage



**matt poliert, Glasbehälter mit Edelstahldeckel und Deckelverschluss**

matt polished, glass with stainless steel cover  
pulido mate, cristal con tapa de acero inoxidable  
verre et inox poli mat, avec couvercle inox

	cm	↑ cm	€
40436	16 x 7,5	24,5	26,50



## Menage „WOOD“

menage  
menage  
ménage



**matt poliert, möbelschonende Unterseite**

matt polished, glass with stainless steel cover  
pulido mate, con tapa de acero inoxidable  
verre et inox poli mat, avec couvercle inox

	cm	↑ cm	€
40437	15,5 x 12	24,5	35,30

**Salz- und Pfefferstreuer / salt - and pepper shaker / juego de sal y pimienta / set sel et poivre**

	Ø cm	↑ cm		€
40438	4	9	6 Löcher - Ø 1,85 mm	4,20
40439	4	9	18 Löcher - Ø 1,35 mm	4,20

**Ersatzglas Essig / Öl / spare glass vinegar / oil / cristal de recambio con tapa „aceite & vinagre“**  
verre huile ou vinagre

	Ø cm	↑ cm	ltr.	€
40442	6	18,5	0,2	7,00



**Menage „ELEMENT“**

menage  
menage  
ménage



**Betonständer, Glasbehälter mit Edelstahldeckel, möbelschonende Unterseite**  
stand made of concrete, glass with stainless steel cover, furniture-friendly underside  
soporte de hormigón, recipiente de vidrio con tapa de acero inoxidable, con base anti rayaduras  
support en béton, récipient en verre avec couvercle en acier inox, revêtement antirayures

	cm	↑ cm	€
40410	10 x 6	17	17,70



**Menage „ELEMENT“**

menage  
menage  
ménage



**Betonständer, Glasbehälter mit Edelstahldeckel und tropffreiem Kunststoff-Ausgießer, möbelschonende Unterseite**  
stand made of concrete, glass with stainless steel cover and non-drip nozzle-spout, furniture-friendly underside  
soporte de hormigón, recipiente de vidrio con tapa de acero inoxidable y sistema antigoteo, base anti rayaduras  
support en béton, récipient en verre avec couvercle en acier inox et verseur antigoutte, revêtement antirayures

	cm	↑ cm	€
40411	14 x 8	25	26,50



**Menage „ELEMENT“**

menage  
menage  
ménage



**Betonständer, Glasbehälter mit Edelstahldeckel und Drehverschluss, möbelschonende Unterseite**  
stand made of concrete, glass with stainless steel cover and screw cap, furniture-friendly underside  
soporte de hormigón, recipiente de vidrio con tapa de acero inoxidable y tapón de rosca, base anti rayaduras  
support en béton, récipient en verre avec couvercle en acier inox et bouchon à vis, avec revêtement antirayures

	cm	↑ cm	€
40412	12,5 x 12,5	25	37,60

## MENAGES



### Menage „CLASSIC“

menage  
menage  
ménage

**Glasbehälter mit Edelstahldeckel und Drehverschluss**

glass with stainless steel cover  
vidrio con tapa de acero inoxidable con rosca  
en verre avec couvercle inox à visser



	cm	↑ cm		€
40310	10,5 x 6,5	16		18,20



### Menage „CLASSIC“

menage  
menage  
ménage

**Glasbehälter mit Edelstahldeckel und Drehverschluss**

glass with stainless steel cover  
vidrio con tapa de acero inoxidable con rosca  
en verre avec couvercle inox à visser



	Ø cm	↑ cm		€
40320	10,5	16		23,00



### Menage „CLASSIC“

menage  
menage  
ménage

**Glasbehälter mit Edelstahldeckel und tropffreiem Kunststoff-Ausgießer**

with stainless steel cover and non-drip nozzle-spout  
vidrio con tapa inox y sistema antigoteo  
verre avec couvercle inox et verseur antigoutte



	cm	↑ cm	ltr.	€
40440	14,5 x 8,5	23	0,2	28,40
40450	17,5 x 10,5	23		33,20

**Ersatzglas mit Deckel / spare glass with cover / vidrio con tapa / verre + couvercle**

	Ø cm	↑ cm		€
40312	4	9	18 Löcher - Ø 1,35 mm	4,20
40311	4	9	6 Löcher - Ø 1,85 mm	4,20

**Ersatzglas mit Deckel „Essig & Öl“ / spare glass with cover „vinegar & oil“ / cristal de recambio con tapa „vinegar & oil“ / verre huile ou vinaige avec couvercle inox et verseur antigoutte**

	Ø cm	↑ cm	ltr.	€
40441	6	18,5	0,2	8,00

**Ersatzglas mit Deckel „Zahnstocher“ / spare glass with cover „toothpick“ / porta-palillos vidrio con tapa / verre à cure-dents + couvercle**

	Ø cm	↑ cm		€
40313	4	9		4,20



### Senftöpfchen, 2er Set

mustard glass, 2 pcs. set  
piezas vasos mostaza, set de 2  
verres à moutarde, set de 2

**inklusive Löffel und Edelstahldeckel**

including spoons and covers  
incluye cucharas y tapas  
cuillères et couvercles inclus



	Ø cm	↑ cm	ltr.	pcs.	€
40415	5	6	0,07	2	5,90





40476



40478



40480

**Menage „PRO“**

menage  
menage  
ménage



**matt poliert, Glasbehälter mit Edelstahldeckel und tropffreiem Kunststoff-Ausgießer**

matt polished, glass with stainless steel cover and non-drip nozzle-spout

pulido mate, vidrio, sistema antigoteo

poli mat et verre, insert plastique antigoutte

	cm	↑ cm	€
40476	12,0 x 8,0	19	11,90
40478	12,5 x 11,0	19	16,70
40480	13,0 x 11,0	19	17,70

**Pfeffer- oder Salz-Glasstreuer / pepper- or salt-glass with cover / salero o pimentero de cristal con tapa / salière ou poivrière seule en verre avec couvercle inox**

	Ø cm	↑ cm	€
40461	3	9	2,20

**Essig- oder Öl-Glasbehälter / oil- or vinegar-glass with cover / aceitera-vinagrera con tapa bouteille huile ou vinaigre seule en verre et couv. inox**

	Ø cm	↑ cm	€
40462	4,5	16	3,60



40470



40472



40474

**Menage „PRO“**

menage  
menage  
ménage



**matt poliert, Glasbehälter mit Edelstahldeckel und Drehverschluss**

matt polished, glass with stainless steel cover

pulido mate, vidrio y tapas con rosca

poli mat et verre, couvercle à visser

	cm	↑ cm	€
40470	8,5 x 5,5	11,5	6,10
40472	9,0 x 8,5	11,5	7,70
40474	10,0 x 10,0	11,5	8,70



**Menage „ECONOMIC“**

menage  
menage  
ménage



**Glasbehälter mit Edelstahldeckel und Drehverschluss**

glass with stainless steel cover  
cristal con tapa inox a rosca  
en verre avec couvercle inox à visser

	cm	↑ cm	€
40455	8 x 4	13	4,70



**Menage „ECONOMIC“**

menage  
menage  
ménage



**Glasbehälter mit Edelstahldeckel und Drehverschluss**

glass with stainless steel cover  
cristal con tapa inox a rosca  
en verre avec couvercle inox à visser

	cm	↑ cm	€
40457	8 x 8	12	7,40

**Glas für Senf / glass for mustard / vaso de cristal para mostaza / pot verre seul pour la moutarde**

	€
40464	2,00



40458

**Menage „ECONOMIC“**

menage  
menage  
ménage



**Glasbehälter mit Edelstahldeckel und tropffreiem Kunststoff-Ausgießer**

glasses with stainless steel cover and non-drip nozzle-spout  
cristales con tapa de acero inoxidable y sistema antigoteo  
en verre avec couvercle inox et insert plastique antigoutte

	cm	↑ cm	€
40458	11,5 x 5,5	22	9,60
40460	11,0 x 10,5	22	13,20

**Pfeffer- oder Salz-Glasstreuer / pepper- or salt-glass with cover salero o pimentero de cristal con tapa / salière ou poivrière seule en verre avec couvercle inox**

	Ø cm	↑ cm	€
40461	3	9	2,20

**Essig- oder Öl-Glasbehälter / oil- or vinegar-glass with cover / aceitera-vinagrera con tapa bouteille huile ou vinaigre seule en verre et couv. inox**

	Ø cm	↑ cm	€
40462	4,5	16	3,60

**Glas für Zahnstocher / glass for tooth picks / vaso de cristal para palillos de dientes porte-cure-dents env erre**

	Ø cm	↑ cm	€
40463	3	6	1,50



40460



**Menage**  
menage  
menage  
ménage



**drehbares Gestell, Glasbehälter mit Edelstahldeckel und Drehverschluss**

rotating stand, glass with stainless steel cover  
soporte giratorio con piezas de vidrio y tapas inox  
tournant, avec pièces en verre et couvercle inox

	Ø cm	↑ cm	€
40485	16	20	20,40



40446

**Essig- & Öl-Menage**  
oil- and vinegar-menage  
aceitera-vinagrera  
ménage huile et vinaigre



**Glasbehälter mit Deckel und tropffreiem PE-Ausgießer**

glass with lid and non-drip nozzle-spout  
recipiente de cristal con tapa y sistema antigoteo  
pot en verre avec couvercle et système plastique antigoutte



	cm	↑ cm	ltr.	€
40445	10,5 x 5,5	24	0,12	10,10
40446	13,0 x 7,0	34	0,50	13,70



**tropffreier Ausgießer**  
non-drip spout



350 ml

**Essig- & Öl-Flasche „OLD FASHIONED“**  
oil- and vinegar bottle  
botella de aceite y vinagre  
bouteille d'huile et vinaigre



**Glasflasche, Edelstahl - Ausgießer mit Deckel**

glass bottle, stainless steel spout with lid  
botella de vidrio, pico verteder de acero inoxidable con tapa  
bouteille en verre, bec verseur en acier inox avec couvercle

	Ø cm	↑ cm	ltr.	€
40511	7	22	0,35	6,40



NEW

**Spritzflasche**  
spray bottle  
botella  
bouteille



**Ausgießer aus Kork, Edelstahl**

cork pouring spout, stainless steel  
pico de corcho, acero inox  
bec verseur liège, acier inox

	cm	↑ cm	ltr.	€
93359	5 x 5	13	0,1	6,40



**Parmesan-Menage „CLASSIC“**

cheese dish  
quesera parmesano  
service à parmesan

**schwarz matt, inklusive Löffel**  
black mat, with spoon  
negro mate, con cuchara  
noir mat, avec cuillère



	Ø cm	↑ cm	ltr.	€
40333	11,0	7,0	0,18	24,00

Ersatzbehälter / sparecontainer / bol de recambio / bol de rechange

	Ø cm	↑ cm	ltr.	€
40331	9,0	5,0	0,18	6,40



**Parmesan-Menage „CLASSIC“**

cheese dish  
quesera parmesano  
service à parmesan

**hochglanzpoliert, inklusive Löffel**  
mirror polished, with spoon  
pulido brillante, con cuchara  
poli brillant, avec cuillère



	Ø cm	↑ cm	ltr.	€
40330	11,0	7,0	0,18	21,00

Ersatzbehälter / sparecontainer / bol de recambio / bol de rechange

	Ø cm	↑ cm	ltr.	€
40331	9,0	5,0	0,18	6,40



**Parmesan-Menage „PROFI“**

cheese dish  
quesera parmesano  
service à parmesan

**hochglanzpoliert, inklusive Löffel**  
mirror polished, with spoon  
pulido brillante, con bol cristal y cuchara  
brillant, avec bol verre et cuillère



	Ø cm	↑ cm	ltr.	€
40424	9,0	6,5	0,18	16,20

Ersatzbehälter / spare container / bol de recambio / bol de rechange

	Ø cm	↑ cm	ltr.	€
40331	9,0	5,0	0,18	6,40



**Parmesan-Menage „PRO“**

cheese dish  
quesera parmesano  
service à parmesan

**matt poliert, inklusive Löffel**  
matt polished, with spoon  
pulido mate, con bol cristal y cuchara  
poli mat, avec bol verre et cuillère



	Ø cm	↑ cm	ltr.	€
40482	10,5	13,0	0,18	11,00

Ersatzbehälter / sparecontainer / bol de recambio / bol de rechange

	Ø cm	↑ cm	ltr.	€
40331	9,0	5,0	0,18	6,40



**Parmesan-Menage „ECONOMIC“**

cheese dish  
quesera parmesano  
service à parmesan  
inklusive Kunststofflöffel  
with spoon  
con cuchara  
avec cuillère



	Ø cm	↑ cm	ltr.	€
40453	10,0	7,5	0,23	7,00

**Ersatzbehälter / sparecontainer / bol de recambio / bol de rechange**

	Ø cm	↑ cm	ltr.	€
40454	9,0	5,5	0,23	2,30



**Ständer „URBAN“**

serving stand  
soporte 2 botellas  
support 2 bouteilles



**Metall schwarz, mit Kartenhalterung**  
metal black, with card holder  
metal negro, con tarjetero  
métal noir, avec porte-cartes

	cm	↑ cm	€
40414	13 x 8,5	25	7,50

**Pfeffermühle / pepper mill / molinillo de pimienta / moulin à poivre**

	Ø cm	↑ cm	€
40555	6	15,5	33,20

**Salzmühle / salt mill / molinillo de sal / moulin à sel**

	Ø cm	↑ cm	€
40556	6	15,5	33,20



mit Kartenhalterung an der Rückseite  
with card holder at the back

# MILLS



## Pfeffermühle

pepper mill  
molinillo de pimienta  
moulin à poivre



aus Buchenholz, Keramikmahlwerk, Mahlgrad stufenlos einstellbar

made of beech wood, ceramic grinder, infinitely adjustable grinding degree

madera de haya, molinillo de cerámica, el grado de molino se puede ajustar de modo continuo

bois de hêtre, moulin en céramique, la finesse de mouture se peut réglée de façon continue

	Ø cm	↑ cm	Farbe / Colour	€
40570	5,5	15,5		19,00
40571	5,5	15,5		19,00
40572	6,0	23,0		22,00
40573	6,0	23,0		22,00



Keramikmahlwerk  
ceramic grinder



einfach zu Öffnen  
easy opening



einfach zu Befüllen  
easy to refill



## Salzmühle

salt mill  
molinillo de sal  
moulin à sel



aus Buchenholz, Keramikmahlwerk, Mahlgrad stufenlos einstellbar

made of beech wood, ceramic grinder, infinitely adjustable grinding degree

madera de haya, molinillo de cerámica, el grado de molino se puede ajustar de modo continuo

bois de hêtre, moulin en céramique, la finesse de mouture se peut réglée de façon continue

	Ø cm	↑ cm	Farbe / Colour	€
40574	5,5	15,5		19,00
40575	5,5	15,5		19,00
40576	6,0	23,0		22,00
40577	6,0	23,0		22,00



Keramikmahlwerk  
ceramic grinder

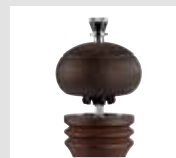

einfach zu Öffnen  
easy opening





P



40535

40548

**Pfeffermühle „PROFESSIONAL VINTAGE“**pepper mill  
molinillo de pimienta  
moulin à poivre**Deutsches Buchenholz, Mahlwerk aus Carbonstahl, Mahlgrad stufenlos einstellbar**

german beechwood, mill in carbon steel, the grinding degree can be adjusted infinitely

madera de haya alemana, molinillo de acero al carbono, el grado de molino se puede ajustar de modo continuo

bois de hêtre d'Allemagne, moulin en acier de carbone, la finesse de mouture se peut réglée de façon continue

	Ø cm	↑ cm	Farbe / Colour	€
40535	5,5	15		24,70
40537	6,0	23		29,20
40546	5,5	15		24,70
40548	6,0	23		29,20

S



40536

40547

**Salzmühle „PROFESSIONAL VINTAGE“**salt mill  
molinillo de sal  
moulin à sel**deutsches Buchenholz, Mahlwerk aus Edelstahl, Mahlgrad stufenlos einstellbar**

german beechwood, mill in stainless steel, the grinding degree can be adjusted infinitely

madera de haya alemana, molinillo de acero inoxidable, el grado de molino se puede ajustar de modo continuo

bois de hêtre d'Allemagne, moulin en acier inox, la finesse de mouture se peut réglée de façon continue

	Ø cm	↑ cm	Farbe / Colour	€
40536	5,5	15		24,70
40547	5,5	15		24,70

P

**Pfeffermühle „GUNMETAL“**pepper mill  
molinillo de pimienta  
moulin à poivre**Mahlwerk aus Carbonstahl, Mahlgrad stufenlos einstellbar**

mill in carbon steel, the grinding degree can be adjusted infinitely

molinillo de acero al carbono, el grado de molino se puede ajustar de modo continuo

moulin en acier de carbone, la finesse de mouture se peut réglée de façon continue

	Ø cm	↑ cm	€
40555	6	15,5	33,20

S

**Salzmühle „GUNMETAL“**salt mill  
molinillo de sal  
moulin à sel**Mahlwerk aus Edelstahl, Mahlgrad stufenlos einstellbar**

mill in stainless steel, the grinding degree can be adjusted infinitely

molinillo de acero inoxidable, el grado de molino se puede ajustar de modo continuo

moulin en acier inox, la finesse de mouture se peut réglée de façon continue

	Ø cm	↑ cm	€
40556	6	15,5	33,20

## SALT- / PEPPER MILLS

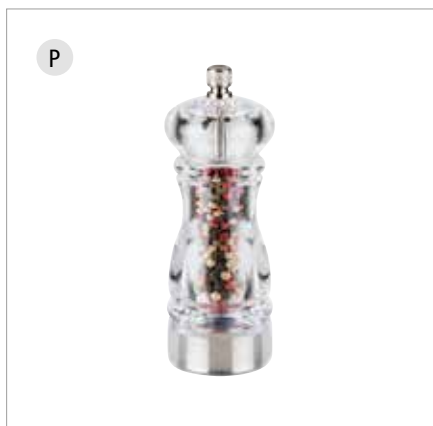

### Pfeffermühle „PROFESSIONAL“

pepper mill  
molinillo de pimienta  
moulin à poivre

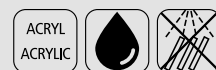

#### Mahlgrad stufenlos einstellbar

the grinding degree can be adjusted infinitely  
el grado de molino se puede ajustar de modo continuo  
la finesse de mouture se peut réglée de façon continue

	Ø cm	↑ cm	€
40540	5,5	15	20,30



### Salzmühle „PROFESSIONAL“

salt mill  
molinillo de sal  
moulin à sel



#### Mahlgrad stufenlos einstellbar

the grinding degree can be adjusted infinitely  
el grado de molino se puede ajustar de modo continuo  
la finesse de mouture se peut réglée de façon continue

	Ø cm	↑ cm	€
40541	5,5	15	20,30



### Pfeffermühle „DIAMOND“

pepper mill  
molinillo de pimienta  
moulin à poivre



#### Mahlwerk aus Carbonstahl, Mahlgrad stufenlos einstellbar

mill in carbon steel, the grinding degree can be adjusted infinitely  
molinillo de acero al carbono, el grado de molino se puede ajustar de modo continuo  
moulin en acier de carbone, la finesse de mouture se peut réglée de façon continue

	Ø cm	↑ cm	€
40553	6	18	17,00



### Salzmühle „DIAMOND“

salt mill  
molinillo de sal  
moulin à sel



#### Mahlwerk aus Edelstahl, Mahlgrad stufenlos einstellbar

mill in stainless steel, the grinding degree can be adjusted infinitely  
molinillo de acero inoxidable, el grado de molino se puede ajustar de modo continuo  
moulin en acier inox, la finesse de mouture se peut réglée de façon continue

	Ø cm	↑ cm	€
40554	6	18	17,00



### Naturschieferplatte / Untersetzer

natural slate tray  
bandeja de pizarra natural  
plateau ardoise naturelle



mit 2 Aussparungen Ø 6 cm / with 2 holes Ø 6 cm / con 2 agujeros Ø 6 cm / avec 2 trous Ø 6 cm

	cm	✦ mm	€
00971	15 x 8	6 - 9	3,40



P

**Pfeffermühle „FRIDA“**

pepper mill  
 molinillo de pimienta  
 moulin à poivre

**Mahlwerk aus Carbonstahl, Mahlgrad stufenlos einstellbar**

mill in carbon steel, the grinding degree can be adjusted infinitely  
 molinillo de acero al carbono, el grado de molino se puede ajustar de modo continuo  
 moulin en acier de carbone, la finesse de mouture se peut réglée de façon continue

	Ø cm	↑ cm	€
40549	6	15,5	18,40

S

**Salzmühle „FRIDA“**

salt mill  
 molinillo de sal  
 moulin à sel

**Mahlwerk aus Edelstahl, Mahlgrad stufenlos einstellbar**

mill in stainless steel, the grinding degree can be adjusted infinitely  
 molinillo de acero inoxidable, el grado de molino se puede ajustar de modo continuo  
 moulin en acier inox, la finesse de mouture se peut réglée de façon continue

	Ø cm	↑ cm	€
40550	6	15,5	18,40

P

**Pfeffermühle „COPPER“**

pepper mill  
 molinillo de pimienta  
 moulin à poivre

**Mahlwerk aus Carbonstahl, Mahlgrad stufenlos einstellbar**

mill in carbon steel, the grinding degree can be adjusted infinitely  
 molinillo de acero al carbono, el grado de molino se puede ajustar de modo continuo  
 moulin en acier de carbone, la finesse de mouture se peut réglée de façon continue

	Ø cm	↑ cm	€
40551	6	15	17,00

S

**Salzmühle „COPPER“**

salt mill  
 molinillo de sal  
 moulin à sel

**Mahlwerk aus Edelstahl, Mahlgrad stufenlos einstellbar**

mill in stainless steel, the grinding degree can be adjusted infinitely  
 molinillo de acero inoxidable, el grado de molino se puede ajustar de modo continuo  
 moulin en acier inox, la finesse de mouture se peut réglée de façon continue

	Ø cm	↑ cm	€
40552	6	15	17,00

## SALT- / PEPPER MILLS



### Pfeffermühle pepper mill molinillo de pimienta moulin à poivre



**Edelstahl, mattiert, Mahlwerk aus Carbonstahl, Mahlgrad stufenlos einstellbar**

stainless steel, matt, mill in carbon steel, grinding degree infinitely adjustable  
acero inoxidable, mate, molinillo de acero al carbono, Molienda ajustable de forma continua  
acier inox, mat, moulin en acier de carbone, réglée de façon continue tige en acier inox

	Ø cm	↑ cm	Farbe / Colour	€
40580	6	13		17,80



### Salzmühle salt mill molinillo de sal moulin à sel



**Edelstahl, mattiert, Mahlwerk aus Edelstahl, Mahlgrad stufenlos einstellbar**

stainless steel, matt, mill in stainless steel, grinding degree infinitely adjustable  
acero inoxidable, mate, molinillo de acero inoxidable, Molienda ajustable de forma continua  
acier inox, mat, moulin en acier inox, réglée de façon continue tige en acier inox

	Ø cm	↑ cm	Farbe / Colour	€
40581	6	13		17,80



### Pfeffermühle pepper mill molinillo de pimienta moulin à poivre



**Mahlwerk aus Carbonstahl, Mahlgrad stufenlos einstellbar**

mill in carbon steel, grinding degree infinitely adjustable  
molinillo de acero al carbono, Molienda ajustable de forma continua  
moulin en acier de carbone, réglée de façon continue tige en acier inox

	Ø cm	↑ cm	Farbe / Colour	€
40582	6	13		17,80



### Salzmühle salt mill molinillo de sal moulin à sel



**Mahlwerk aus Edelstahl, Mahlgrad stufenlos einstellbar**

mill in stainless steel, grinding degree infinitely adjustable  
molinillo de acero inoxidable, Molienda ajustable de forma continua  
moulin en acier inox, réglée de façon continue tige en acier inox

	Ø cm	↑ cm	Farbe / Colour	€
40583	6	13		17,80

P

**Pfeffermühle „ELEMENT“**

pepper mill  
molinillo de pimienta  
moulin à poivre



**Mahlwerk aus Carbonstahl, Mahlgrad stufenlos einstellbar**

mill in carbon steel, the grinding degree can be adjusted infinitely

molinillo de acero al carbono, el grado de molino se puede ajustar de modo continuo

moulin en acier de carbone, la finesse de mouture se peut régler de façon continue

	Ø cm	↑ cm	€
40538	6	18	27,00

S

**Salzmühle „ELEMENT“**

salt mill  
molinillo de sal  
moulin à sel



**Mahlwerk aus Edelstahl, Mahlgrad stufenlos einstellbar**

mill in stainless steel, the grinding degree can be adjusted infinitely

molinillo de acero inoxidable, el grado de molino se puede ajustar de modo continuo

moulin en acier inox, la finesse de mouture se peut régler de façon continue

	Ø cm	↑ cm	€
40539	6	18	27,00

P

**Pfeffermühle „ELEMENT“**

pepper mill  
molinillo de pimienta  
moulin à poivre



**Mahlwerk aus Carbonstahl, Mahlgrad stufenlos einstellbar**

mill in carbon steel, the grinding degree can be adjusted infinitely

molinillo de acero al carbono, el grado de molino se puede ajustar de modo continuo

moulin en acier de carbone, la finesse de mouture se peut régler de façon continue

	Ø cm	↑ cm	€
40557	7,5	15,5	23,60

S

**Salzmühle „ELEMENT“**

salt mill  
molinillo de sal  
moulin à sel



**Mahlwerk aus Edelstahl, Mahlgrad stufenlos einstellbar**

mill in stainless steel, the grinding degree can be adjusted infinitely

molinillo de acero inoxidable, el grado de molino se puede ajustar de modo continuo

moulin en acier inox, la finesse de mouture se peut régler de façon continue

	Ø cm	↑ cm	€
40558	7,5	15,5	23,60

## SALT- / PEPPER MILLS



Mahlwerk aus Carbonstahl  
mill in carbon steel

### Pfeffermühle

pepper mill  
molinillo de pimienta  
moulin à poivre



**Akazienholz, Mahlwerk aus Carbonstahl, Mahlgrad stufenlos einstellbar**

acacia wood, mill in carbon steel, grinding degree infinitely adjustable  
madera de acacia, molinillo de acero al carbono, Molienda ajustable de forma continua  
bois d'acacia, moulin en acier de carbone, réglée de façon continue tige en acier inox

	Ø cm	↑ cm	Farbe / Colour	€
40578	5	17	■	16,00



Mahlwerk aus Edelstahl  
mill in stainless steel

### Salzmühle

salt mill  
molinillo de sal  
moulin à sel



**Akazienholz, Mahlwerk aus Edelstahl, Mahlgrad stufenlos einstellbar**

acacia wood, mill in stainless steel, grinding degree infinitely adjustable  
madera de acacia, molinillo de acero inoxidable, Molienda ajustable de forma continua  
bois d'acacia, moulin en acier inox, réglée de façon continue tige en acier inox

	Ø cm	↑ cm	Farbe / Colour	€
40579	5	17	■	16,00

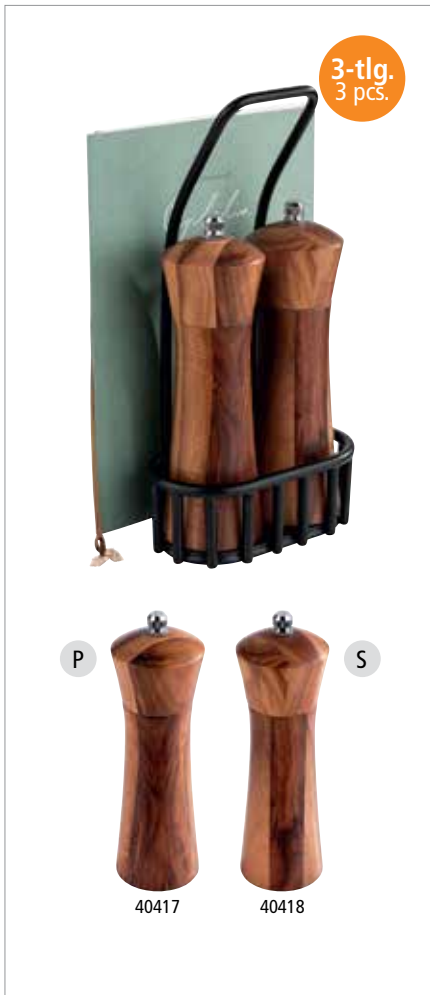

### Pfeffer- und Salz-Menage „URBAN“

salt- and pepper-menage  
salero-pimentero  
ménage sel et poivre



3-teiliges Set, bestehend aus:

- Gestell, Metall, schwarz, mit Kartenhalterung
- Pfeffermühle aus Akazienholz mit Mahlwerk aus Carbonstahl
- Salzmühle aus Akazienholz mit Mahlwerk aus Edelstahl

3 pcs., consisting of:

- stand, metal, black, with card holder
- pepper mill made of acacia wood with grinding mechanism made of carbon steel
- salt mill made of acacia wood with grinding mechanism made of stainless steel

set de 3, compuesto por:

- soporte, metal, negro, con porta menu
- molinillo de pimienta de madera de acacia con mecanismo de molienda de acero al carbono
- molinillo de sal de madera de acacia con mecanismo de molienda de acero inoxidable

set de 3, composé de :

- support, métal, noir, avec porte-cartes
- moulin à poivre en bois d'acacia avec broyeur en acier au carbone
- moulin à sel en bois d'acacia avec broyeur en acier inox

	cm	↑ cm	€
40416	12 x 8,5	24	38,00

Pfeffermühle / pepper mill / molinillo de pimienta / moulin à poivre

	Ø cm	↑ cm	€
40417	5	17	16,00

Salzmühle / salt mill / molinillo de sal / moulin à sel

	Ø cm	↑ cm	€
40418	5	17	16,00



**2 in 1 Salz und Pfeffermühle**

2 in 1 salt and pepper mill  
2 en 1 molinillo sal y pimienta  
2 en 1 moulin à sel et poivre

**Keramikmahlwerk, Mahlgrad einstellbar**

ceramic grinder, adjustable grinding degree  
molinillo de cerámica, grado de molienda ajustable  
moulin en céramique, degré de mouture réglable



	cm	↑ cm	Farbe / Colour	€
40561	6 x 5	8		16,00
40562	6 x 5	8		16,00
40563	6 x 5	8		16,00
40543	6 x 5	8		16,00



Mahlgrad einstellbar  
adjustable grinding degree

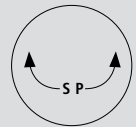

**2 in 1 Salz- und Pfeffermühle**

2 in 1 salt and pepper mill  
2 in 1 molinillo de sal y pimienta  
2 in 1 moulin à sel et poivre

**Keramik Mahlwerk / ceramic mechanism / molinillo de cerámica / broyeur en céramique**



	cm	↑ cm	€
40544	6 x 4,5	9,5	21,00



Mahlgrad einstellbar  
grinder setting

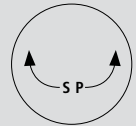

**2 in 1 Salz- und Pfeffermühle**

2 in 1 salt and pepper mill  
2 in 1 molinillo de sal y pimienta  
2 in 1 moulin à sel et poivre

**Keramik Mahlwerk / ceramic mechanism / molinillo de cerámica / broyeur en céramique**



	Ø cm	↑ cm	€
40545	7,5	18,5	23,00



Mahlgrad einstellbar  
grinder setting

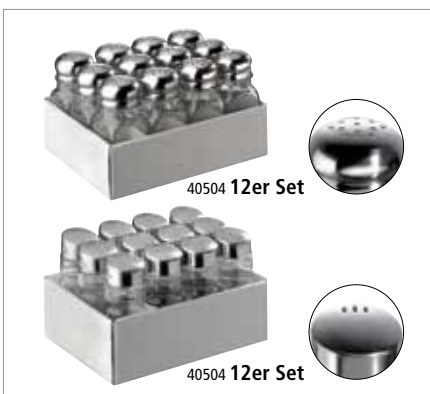
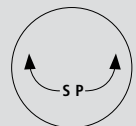

**Allzweckstreuer, 12er Set**

shaker, 12 pcs.  
dosificador, set de 12  
salières/poivrières, set de 12



	cm	↑ cm	pcs.	€ / set	
40504	4 x 4	10	12	13 Löcher / 13 holes 13 agujeros / 13 trous	23,40
40505	Ø cm	↑ cm	pcs.	€ / set	
	3	9	12	3 Löcher / 3 holes 3 agujeros / 3 trous	18,60

## SALT- / PEPPER MILLS



### Salz- und Pfefferstreuer, 2er Set

salt - and pepper shaker, 2 pcs.  
piezas de sal y pimienta, set de 2  
sel et poivre, set de 2



	Ø cm	↑ cm	pcs.		€/ set
40501	5	6,5	2	geriffelte Ausführung / fluted version	3,20
40507	6	10,0	2		10,40



### Ministreuer, 4er Set

mini shaker, 4 pcs.  
dosificador mini, set de 4  
mini-salières, set de 4



	Ø cm	↑ cm	pcs.		€/ set
40503	3,5	4	4		5,50



### Netzstreuer

mesh top shaker  
polvoreador, tapa con malla fina  
pot à épices, couvercle toile fine



	Ø cm	↑ cm	litr.		€
00776	5,5	7,5	0,15		5,60



### Streuer fein

small hole shaker  
polvoreador, tapa con agujeros pequeños  
pot à épices, couvercle à petits trous



	Ø cm	↑ cm	litr.		€
00777	5,5	7,5	0,15		5,00



### Streuer grob

large hole shaker  
polvoreador, tapa con agujeros grandes  
pot à épices, couvercle à grands trous



	Ø cm	↑ cm	litr.		€
00778	5,5	7,5	0,15		5,00



### Käse- oder Gewürzstreuer

spice shaker  
bote especiero  
saupoudreuse à épices



	Ø cm	↑ cm	litr.		€
00775	5,5	7,5	0,15		5,60



### Salzstreuer

salt shaker  
salero  
salière



**Pommes-Frites Streuer mit Schraubkappe / for french fries, cover to screw / para patatas fritas, tapa de rosca / pour les frites, couvercle à visser**

	Ø cm	↑ cm		€
00779	8	17	Aluminium / aluminium	9,90
00772	8	17	Edelstahl / stainless steel	15,00



**Holzbox „WOODY“**

woodbox  
caja madera  
base bois



**Akazienholz, 4-Fächer: 12,5 x 8 cm** / acacia wood, 4 compartments: 12,5 x 8 cm  
madera de acacia, 4 compartimentos: 12,5 x 8 cm / bois d'acacia, 4 compartiments : 12,5 x 8 cm

	cm	↑ cm	€
11649	36 x 14	12,5	16,80



**Servierbeispiel**  
**Lieferung ohne Gläser**  
delivery without glasses

**Holzbox „TABLE“**

woodbox  
caja madera  
base bois



**Akazienholz, 3 Fächer: 6,5 x 6,5 cm** / acacia wood, 3 compartments: 6,5 x 6,5 cm  
madera de acacia, 3 compartimentos: 6,5 x 6,5 cm / bois d'acacia, 3 compartiments : 6,5 x 6,5 cm

	cm	↑ cm	€
11727	23,5 x 8,5	4,5	12,90



**Holzbox „TABLE“**

woodbox  
caja madera  
base bois



**Akazienholz, 1 Fach: 12 x 6,5 cm**  
acacia wood, 1 compartment: 12 x 6,5 cm  
madera de acacia, 1 compartimento: 12 x 6,5 cm  
bois d'acacia, 1 compartiment: 12 x 6,5 cm

	cm	↑ cm	€
11726	15,0 x 9,5	5	9,90



**Table Caddy**

table caddy  
caddy de mesa  
caddy de table



**Akazienholz, 1 Fach: 21,5 x 8 cm**  
acacia wood, 1 compartment: 21,5 x 8 cm  
madera de acacia, 1 compartimento: 21,5 x 8 cm  
bois d'acacia, 1 compartiment: 21,5 x 8 cm

	cm	↑ cm	€
11625	23 x 10	10	11,20



**Holzbox „WOODY“**

woodbox  
caja madera  
base bois



**Akazienholz, 1 Fach: 13 x 13 cm**  
acacia wood, 1 compartment: 13 x 13 cm  
madera de acacia, 1 compartimento: 13 x 13 cm  
bois d'acacia, 1 compartiment : 13 x 13 cm

	cm	↑ cm	€
11650	15,0 x 15	5,5	12,50

**Akazienholz, 2 Fächer: 13,5 x 13 cm / 6,5 x 13 cm**  
acacia wood, 2 compartments: 13,5 x 13 cm / 6,5 x 13 cm  
madera de acacia, 2 compartimentos: 13,5 x 13 cm / 6,5 x 13 cm  
bois d'acacia, 2 compartiments : 13,5 x 13 cm / 6,5 x 13 cm

	cm	↑ cm	€
11651	22,5 x 15	5,5	15,70

# BUTTER DISHES



15925



15926

**Butterservierer**  
butter dish  
mantequillera  
beurrier



	cm	↑ cm	ltr.	€
15925	Ø 9	9	0,07	8,80
15926	9 x 9	9	0,075	8,80



**Butterservierer**  
butter dish  
mantequillera  
beurrier



hochglanzpoliert  
mirror polished  
acabado brillante  
poli brillant

	Ø cm	↑ cm	ltr.	€
15921	9	7	0,06	16,00





40668

Schale „ENAMELWARE“

bowl  
cuenco  
bol



	cm	↑ cm	ltr.	€
40667	16 x 12,0	3,5	0,20	7,90
40668	18 x 13,5	4,0	0,35	8,60



Butterdose

butter dish  
mantequillera  
boîte à beurre



	cm	↑ cm	€
00063	16 x 9,5	5,5	4,20



Eierbecher

egg holder  
huevera  
coquetier



	Ø cm	↑ cm	€
00032	8,5	2	1,60



83849

83848

Eierbecher, 4er Set

egg holder, 4 pcs. set  
huevera, set de 4  
coquetier, set de 4



	Ø cm	↑ cm	pcs.	Farbe / Colour	€ / set
83849	8,5	2	4	Black	7,60
83848	8,5	2	4	White	7,60



Eierbecher, 4er Set

egg holder, 4 pcs. set  
huevera, set de 4  
coquetier, set de 4



	Ø cm	↑ cm	pcs.	€ / set
83851	8	3	4	8,00



# GRAVY BOATS



## Sauciere „PROFI“

gravy boat  
salsera  
saucière

hochglanzpoliert, extra schwere Qualität  
mirror polished, high quality  
pulido brillante, alta calidad, base pesada  
poli brillant, belle qualité, pied pesant



	cm	↑ cm	ltr.	€
40208	13 x 6,0	9,0	0,075	6,60
40204	16 x 7,5	9,0	0,125	7,60
40205	19 x 9,0	13,0	0,25	9,90
40206	22 x 10,5	13,5	0,4	12,00



## Sauciere „ECO“

gravy boat  
salsera  
saucière

hochglanzpoliert  
mirror polished  
pulido brillante  
poli brillant



	cm	↑ cm	ltr.	€
40200	18,0 x 7,5	7,0	0,10	4,90
40203	21,5 x 9,5	8,5	0,15	5,70
40201	23,5 x 10,0	10,0	0,20	6,00
40202	23,5 x 12,0	12,0	0,45	7,40



**Thermo-Sauciere**  
insulated sauce boat  
salsera isotérmica  
saucière thermique



**doppelwandig, Klappdeckelverschluss, Einhandbedienung**

double wall, hinged cover, one-hand operation  
doble pared, tapa con bisagra, se maneja con 1 mano  
double paroi, couvercle avec charnière, usage 1 main

	cm	↑ cm	ltr.	€
40207	19 x 12,5	13	0,4	16,00



**Glocke**  
cloche / dome cover  
campana esférica  
cloche demi-sphère



**außen hochglanzpoliert, innen matt poliert, mit verchromten Griff**  
outside mirror polished, inside matt polished, with chromeplated handle  
exterior pulido brillante, interior pulido mate, pomo cromado  
extérieur poli brillant, intérieur poli mat, buton chromé

	Ø cm	↑ cm	€
35734	29	18	56,00



**Platzteller**  
plate tray  
bajo plato  
assiette de présentation



**hochglanzpoliert, mit Fadendekor**  
mirror polished, with line edge  
pulido brillante, con un filo en relieve  
poli brillant, filet relief

	Ø cm	€
35730	30,5	15,20
36233	33,0	21,00



**Platzteller**  
plate tray  
bajo plato  
assiette de présentation



**hochglanzpoliert, mit Perlrand**  
mirror polished, with pearl edge  
acabado pulido brillante, con borde aperlado  
poli brillant, bord perlé

	Ø cm	€
35720	30,5	15,40
36323	33,0	18,20



**Tischkrümelentferner**  
crumber  
recogemigas  
ramasse-miettes



**matt poliert, geschliffene Edelstahlkante**  
matt polished, flat grinded stainless steel edge  
pulido mate, borde plano de acero inoxidable rectificado  
poli mat, bord plat rectifié en acier inox

	cm	↑ cm	€
00581	19,0 x 4,5	1	8,00

## COASTERS



### Untersetzer, 6er Set

coaster, 6 pcs.  
posavasos, set de 6  
plateau sous-verre, set de 6

hochglanzpoliert, schwere Ausführung, Rand eingerollt  
mirror polished, heavy quality, rolled edge  
pulido brillante, alta calidad, borde redondeado  
poli brillant, bord rond, qualité extra

EDELSTAHL  
STAINLESS  
INOX  
18/8



	Ø cm	pcs.	€/ set
35711	10	6	22,00
35912	12	6	17,00



### Untersetzer, 6er Set

coaster, 6 pcs.  
posavasos, set de 6  
plateau sous-verre, set de 6

KUNSTLEDER  
LEATHERETTE



	Ø cm	pcs.	€/ set
35716	11	6	17,00



### Serviettenringe, 4er Set

napkin rings, 4 pcs.  
servilleteros, set de 4  
anneaux porte-serviette, set de 4

EDELSTAHL  
STAINLESS  
INOX



	Ø cm	↑ cm	pcs.	€/ set
04446	4,5	2,5	4	8,40



### Rechnungstablett

bill presenter  
porta cuenta  
porte-addition  
mit Klemme für Rechnung  
with clip for bill  
con clip para la nota  
avec clip pour la note

EDELSTAHL  
STAINLESS  
INOX



	cm	↑ cm	€
30110	17 x 11	1,0	6,30



### Rechnungstablett

bill presenter  
porta cuenta  
porte-addition  
mit Klemme für Rechnung  
with clip for bill  
con clip para la nota  
avec clip pour la note

ABS  
KUNSTSTOFF



	cm	↑ cm	€
30108	20 x 12	0,5	2,40

# FONDUE



2,2 ltr.

65060

## Fondue und Feuerzangenbowl-Set „TWO IN ONE“

fondue and fire punch bowl set  
set para fondue o ponche caliente  
service à fondue et à punch



13-teiliges Set aus Edelstahl bestehend aus:

1 Topf, 1 Rechaud, 1 Spritzschutz, 1 Untersetzer, 1 Schöpfkelle, 1 Feuerzange,  
1 Pastenbrenner, 6 Fonduegabeln

13-piece stainless steel set consisting of:

1 pot, 1 rechaud, 1 splash guard, 1 coaster, 1 ladle, 1 fire tongs,  
1 paste burner, 6 fondue forks

set de 13 piezas de acero inoxidable compuesto por:

1 olla, 1 rechaud, 1 protector contra salpicaduras, 1 trébede, 1 cazo,  
1 pinza para el fuego, 1 quemador de pasta, 6 tenedores de fondue

set de 13 pièces en acier inox comprenant:

1 marmite, 1 rechaud, 1 pare-éclaboussures, 1 dessous de plat, 1 louche, 1 pince à feu,  
1 brûleur à pâte, 6 fourchettes à fondue

	Ø cm	↑ cm	ltr.	€ / set
65060	22	23	2,2	52,50



## Kaviarkühler

caviar cooler  
enfriador de caviar  
rafraîchisseur de caviar



4-teilig: Glasschale Ø 10 cm / 4 pcs.: glass bowl Ø 10 cm / set de 4: bol Ø 10 cm  
set de 4: bol Ø 10 cm

	Ø cm	↑ cm	€
01699	18	12	56,00

# PLACEMATS



Tischset  
placemat  
mantelín  
set de table



	cm		VE / unit	€ / pc.
60580	45 x 33	beige / beige	24	6,20



rutschhemmende Unterseite  
non-slip bottom



Tischset  
placemat  
mantelín  
set de table



	cm		VE / unit	€ / pc.
60581	45 x 33	grün / green	24	6,20



rutschhemmende Unterseite  
non-slip bottom



Tischset  
placemat  
mantelín  
set de table



	cm		VE / unit	€ / pc.
60582	45 x 33	blau / blue	24	6,20

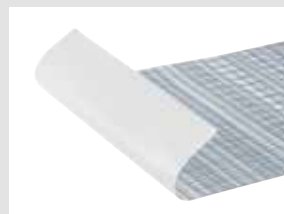

rutschhemmende Unterseite  
non-slip bottom



Tischset  
placemat  
mantelín  
set de table



	cm		VE / unit	€ / pc.
60584	45 x 33	beige / beige	24	6,20



rutschhemmende Unterseite  
non-slip bottom



Tischset  
placemat  
mantelín  
set de table



	cm		VE / unit	€ / pc.
60583	45 x 33	anthrazit / anthracite	24	6,20



rutschhemmende Unterseite  
non-slip bottom



Tischset  
placemat  
mantelín  
set de table



	cm		VE / unit	€ / pc.
60585	45 x 33	grün / green	24	6,20



rutschhemmende Unterseite  
non-slip bottom



Tischset  
placemat  
mantelín  
set de table



	cm		VE / unit	€ / pc.
60586	45 x 33	dunkelblau / dark blue	24	6,20



rutschhemmende Unterseite  
non-slip bottom

# PLACEMATS



Die umgelegten und angenähten Kanten machen diese Tischsets besonders robust. Geliefert in einer 6er Einheit.

The folded and sewn edges make these table sets particularly robust. Delivered in a packing unit of 6 pieces.

Los bordes doblados y cosidos des los mantelitos los hacen especialmente resistentes. Se entregan en una unidad de embalaje de 6 piezas.

Les bords repliés et cousus rendent ces sets de table en particulierement robustes. Livré dans un emballage de 6 pièces.



## Warenträger - Tischsets

display for placemats  
expositor para mantelinas de mesa  
présentoir pour sets de table

12 Einschubfächer, komplett auf Rollen, 2 Feststellrollen, Lieferung demontiert

12 shelves, on rolls, 2 rolls to fix, delivery unassembled

12 niveles, 4 ruedas, desmontado (montaje fácil)

12 niveaux, 4 roues, livré démonté

	cm	↑ cm
00401	39,5 x 45	165



## Tischset Feinband „TAO“

placemat fine band  
mantelín cinta fina  
set de table, tressage fin



	cm		VE / unit	€ / pc.
60503	45 x 33	beige / beige	6	4,20



## Tischset Feinband

placemat fine band  
mantelín cinta fina  
set de table, tressage fin



	cm		VE / unit	€ / pc.
60038	45 x 33	beige braun / beige brown	6	3,30



## Tischset Feinband

placemat fine band  
mantelín cinta fina  
set de table, tressage fin



	cm		VE / unit	€ / pc.
60037	45 x 33	gold / gold	6	3,30



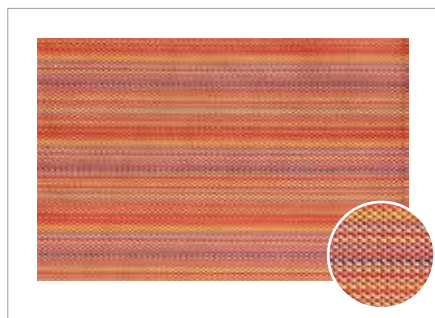

**Tischset Feinband**  
 placemat fine band  
 mantelín cinta fina  
 set de table, tressage fin



	cm		VE / unit	€ / pc.
60511	45 x 33	LINES orange, gelb / LINES orange yellow	6	3,30



**Tischset Feinband**  
 placemat fine band  
 mantelín cinta fina  
 set de table, tressage fin



	cm		VE / unit	€ / pc.
60510	45 x 33	LINES orange, rot / LINES orange red	6	3,30

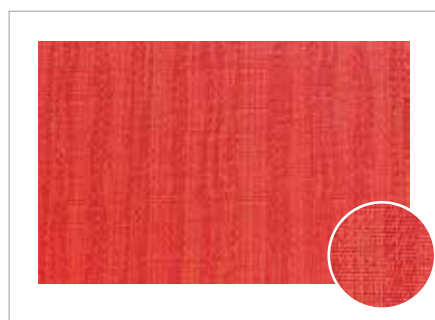

**Tischset Feinband**  
 placemat fine band  
 mantelín cinta fina  
 set de table, tressage fin



	cm		VE / unit	€ / pc.
60542	45 x 33	rot / red	6	3,30



**Tischset Feinband**  
 placemat fine band  
 mantelín cinta fina  
 set de table, tressage fin



	cm		VE / unit	€ / pc.
60042	45 x 33	türkis, grün, weiß / turquoise, green, white	6	3,30

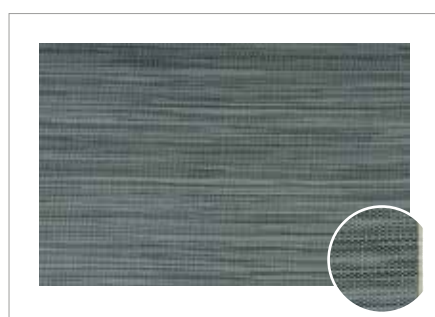

**Tischset Feinband „TAO“**  
 placemat fine band  
 mantelín cinta fina  
 set de table, tressage fin



	cm		VE / unit	€ / pc.
60508	45 x 33	hellblau, dunkelblau / light blue, dark blue	6	4,70

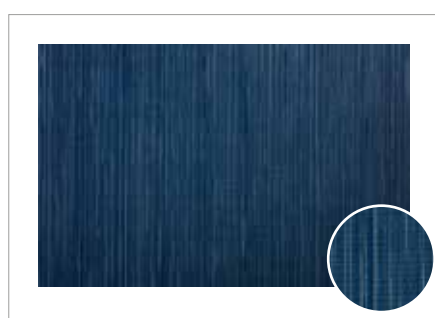

**Tischset Feinband**  
 placemat fine band  
 mantelín cinta fina  
 set de table, tressage fin



	cm		VE / unit	€ / pc.
60040	45 x 33	blau / blue	6	3,30

## PLACEMATS

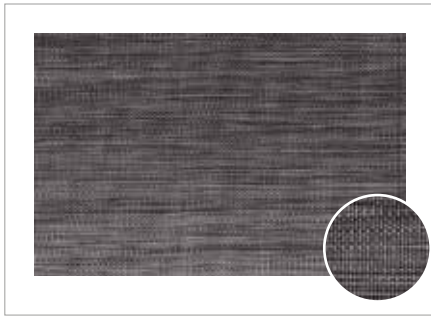

**Tischset Feinband**  
placemat fine band  
mantelín cinta fina  
set de table, tressage fin



	cm		VE / unit	€ / pc.
60512	45 x 33	schwarz, grau / black, grey	6	3,30



**Tischset Feinband**  
placemat fine band  
mantelín cinta fina  
set de table, tressage fin



	cm		VE / unit	€ / pc.
60531	45 x 33	LINES schwarz / LINES black	6	3,30

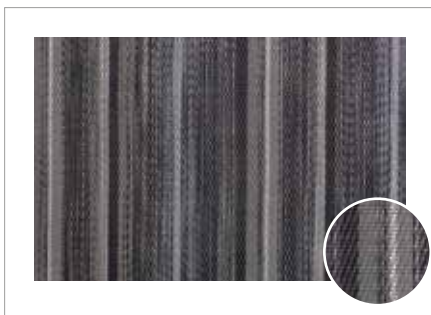

**Tischset Feinband**  
placemat fine band  
mantelín cinta fina  
set de table, tressage fin



	cm		VE / unit	€ / pc.
60530	45 x 33	STRIPES grau / STRIPES grey	6	3,30



**Tischset Feinband**  
placemat fine band  
mantelín cinta fina  
set de table, tressage fin



	cm		VE / unit	€ / pc.
60540	45 x 33	FRAMES grau / FRAMES grey	6	3,30



**Tischset Feinband**  
placemat fine band  
mantelín cinta fina  
set de table, tressage fin



	cm		VE / unit	€ / pc.
60541	45 x 33	FRAMES schwarz / FRAMES black	6	3,30

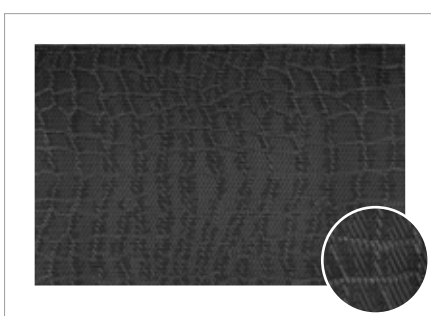

**Tischset Feinband**  
placemat fine band  
mantelín cinta fina  
set de table, tressage fin



	cm		VE / unit	€ / pc.
60509	45 x 33	Mosaik schwarz, grau / black, grey	6	3,30

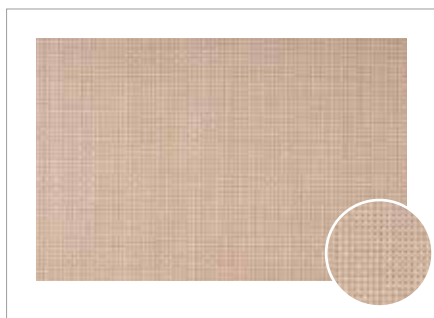

**Tischset Schmalband**  
 placemat smallband  
 mantelín cinta estrecha  
 set de table tressage étroit



	cm		VE / unit	€ / pc.
60014	45 x 33	beige / beige	6	3,30

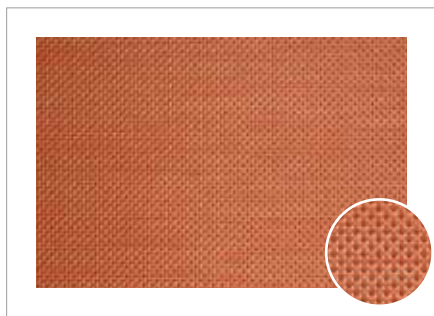

**Tischset Schmalband**  
 placemat smallband  
 mantelín cinta estrecha  
 set de table tressage étroit



	cm		VE / unit	€ / pc.
60018	45 x 33	candyrot / candyred	6	3,30

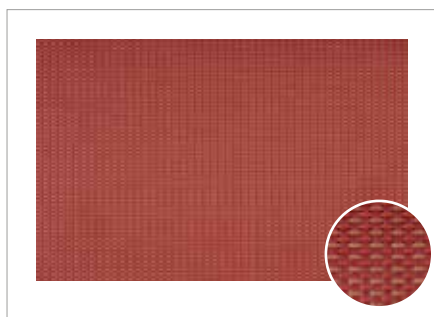

**Tischset Schmalband**  
 placemat smallband  
 mantelín cinta estrecha  
 set de table tressage étroit



	cm		VE / unit	€ / pc.
60522	45 x 33	hellorange / light orange	6	3,30

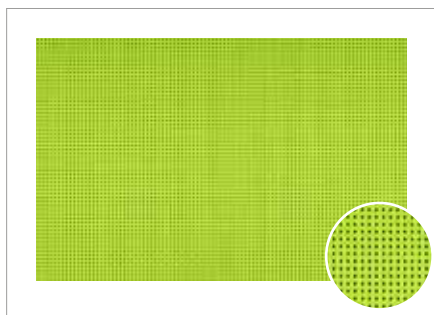

**Tischset Schmalband**  
 placemat smallband  
 mantelín cinta estrecha  
 set de table tressage étroit



	cm		VE / unit	€ / pc.
60016	45 x 33	grün / green	6	3,30



**Tischset Schmalband**  
 placemat smallband  
 mantelín cinta estrecha  
 set de table tressage étroit



	cm		VE / unit	€ / pc.
60528	45 x 33	grün / green	6	3,30



**Tischset Schmalband**  
 placemat smallband  
 mantelín cinta estrecha  
 set de table tressage étroit



	cm		VE / unit	€ / pc.
60521	45 x 33	apfelgrün / apple green	6	3,30

## PLACEMATS

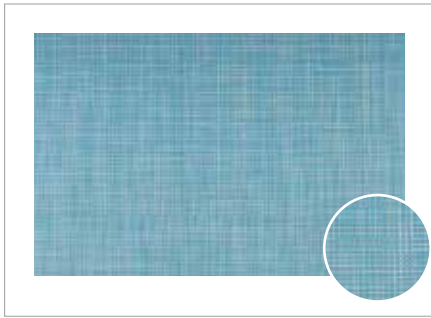

**Tischset Schmalband**  
 placemat smallband  
 mantelín cinta estrecha  
 set de table tressage étroit



	cm		VE / unit	€ / pc.
60041	45 x 33	hellblau, weiß / light blue, white	6	3,30

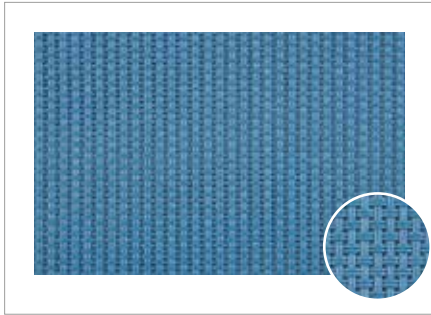

**Tischset Schmalband**  
 placemat smallband  
 mantelín cinta estrecha  
 set de table tressage étroit



	cm		VE / unit	€ / pc.
60002	45 x 33	hellblau / light blue	6	3,30

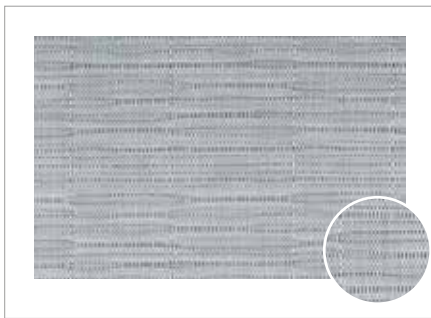

**Tischset Schmalband**  
 placemat smallband  
 mantelín cinta estrecha  
 set de table tressage étroit



	cm		VE / unit	€ / pc.
60527	45 x 33	silber / silver	6	3,30

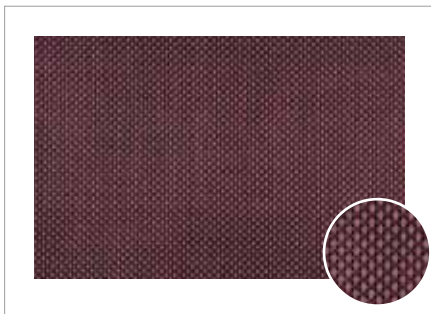

**Tischset Schmalband**  
 placemat smallband  
 mantelín cinta estrecha  
 set de table tressage étroit



	cm		VE / unit	€ / pc.
60523	45 x 33	violett / purple	6	3,30



**Tischset Schmalband**  
 placemat smallband  
 mantelín cinta estrecha  
 set de table tressage étroit



	cm		VE / unit	€ / pc.
60525	45 x 33	weiß / white	6	3,30

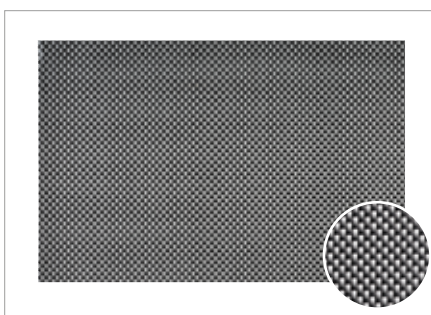

**Tischset Schmalband**  
 placemat smallband  
 mantelín cinta estrecha  
 set de table tressage étroit



	cm		VE / unit	€ / pc.
60520	45 x 33	schwarz weiß / black white	6	3,30

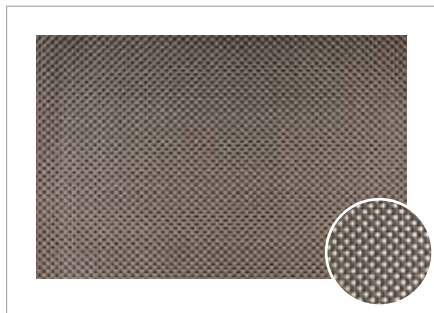

**Tischset Schmalband**  
 placemat smallband  
 mantelín cinta estrecha  
 set de table tressage étroit



cm			VE / unit	€ / pc.
60524	45 x 33	platin / platinum	6	3,30

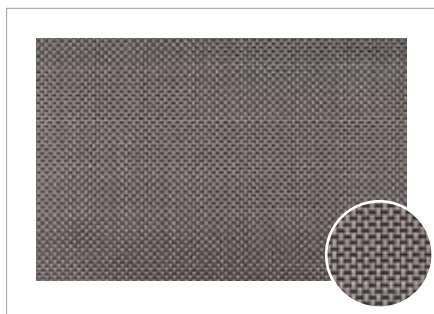

**Tischset Schmalband**  
 placemat smallband  
 mantelín cinta estrecha  
 set de table tressage étroit



cm			VE / unit	€ / pc.
60015	45 x 33	silbergrau / silvergry	6	3,30



**Tischset Schmalband**  
 placemat smallband  
 mantelín cinta estrecha  
 set de table tressage étroit



cm			VE / unit	€ / pc.
60526	45 x 33	gold / gold	6	3,30

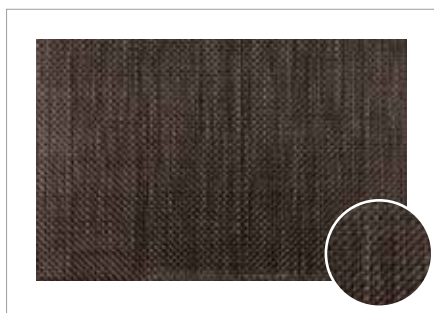

**Tischset Schmalband**  
 placemat smallband  
 mantelín cinta estrecha  
 set de table tressage étroit



cm			VE / unit	€ / pc.
60019	45 x 33	beige braun / beige brown	6	3,30

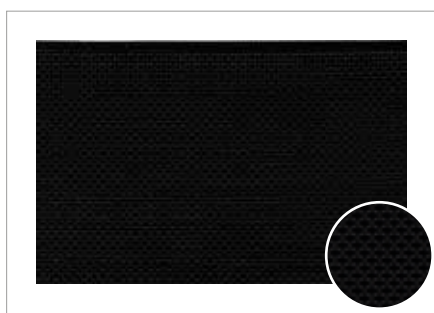

**Tischset Schmalband**  
 placemat smallband  
 mantelín cinta estrecha  
 set de table tressage étroit



cm			VE / unit	€ / pc.
60012	45 x 33	schwarz / black	6	3,30



**Servietten- und Bestecktaschen, 6er Set**  
 cutlery bag, 6 pcs. set  
 bolsa cubiertos, set de 6  
 pochette couverts, set de 6



cm			pcs.	€ / set
60551	24 x 9	silbergrau / silvergry	6	4,20

## PLACEMATS

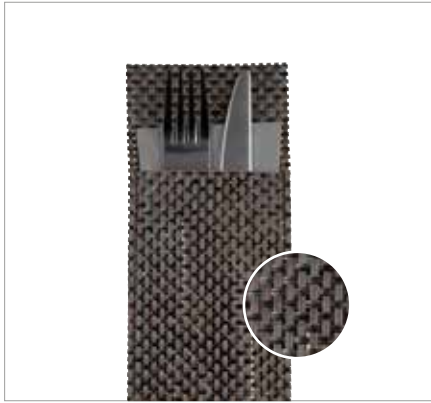

### Servietten- und Bestecktaschen, 6er Set

cutlery bag, 6 pcs. set  
bolsa cubiertos, set de 6  
pochette couverts, set de 6



	cm		pcs.	€ / set
60552	24 x 9	beige braun / beige brown	6	4,20

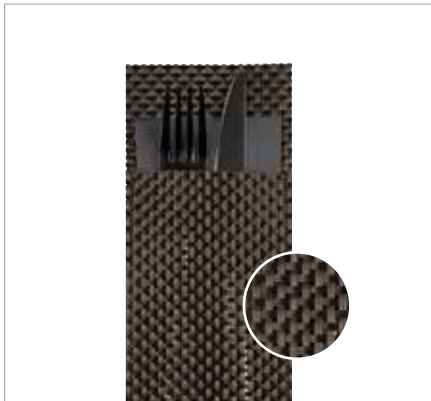

### Servietten- und Bestecktaschen, 6er Set

cutlery bag, 6 pcs. set  
bolsa cubiertos, set de 6  
pochette couverts, set de 6



	cm		pcs.	€ / set
60554	24 x 9	platin / platinum	6	4,20

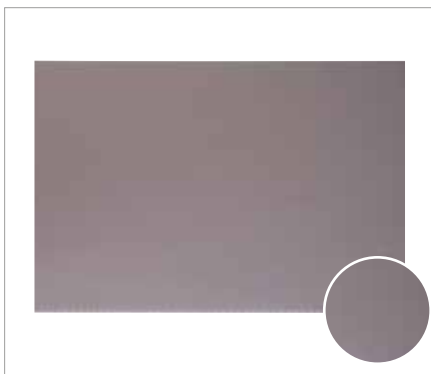

### Tischset

placemat  
mantelín  
set de table



#### Kunstleder, mit Naht rundherum

imitation leather, with seam all around  
imitación de cuero, con costura alrededor  
similicuir, avec couture tout autour

	cm		VE / unit	€ / pc.
60044	45 x 32,5	grau / grey	6	10,80

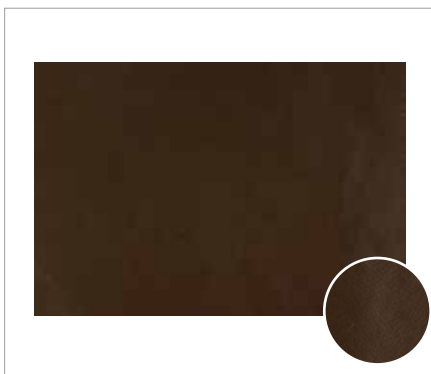

### Tischset

placemat  
mantelín  
set de table



#### Kunstleder, mit Naht rundherum

imitation leather, with seam all around  
imitación de cuero, con costura alrededor  
similicuir, avec couture tout autour

	cm		VE / unit	€ / pc.
60045	45 x 32,5	braun / brown	6	10,80

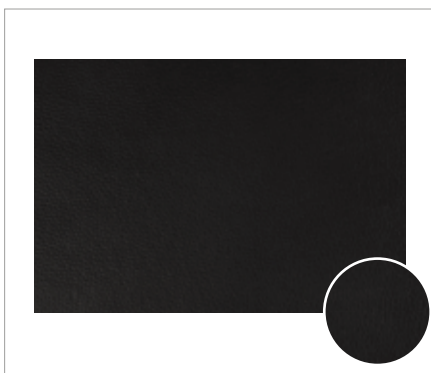

### Tischset

placemat  
mantelín  
set de table



#### Kunstleder, mit Naht rundherum

imitation leather, with seam all around  
imitación de cuero, con costura alrededor  
similicuir, avec couture tout autour

	cm		VE / unit	€ / pc.
60046	45 x 32,5	schwarz / black	6	10,80



**Tischset**  
 placemat  
 mantelín  
 set de table



**rutschhemmende Unterseite**  
 slip resistant underside  
 parte inferior antideslizante  
 dessous antidérapant

cm			VE / unit	€ / pc.
60544	45 x 30	sand / sand	6	5,50



**Tischset**  
 placemat  
 mantelín  
 set de table



**rutschhemmende Unterseite**  
 slip resistant underside  
 parte inferior antideslizante  
 dessous antidérapant

cm			VE / unit	€ / pc.
60545	45 x 30	bronze/schwarz / bronze/black	6	5,50



**Tischset**  
 placemat  
 mantelín  
 set de table



**rutschhemmende Unterseite**  
 slip resistant underside  
 parte inferior antideslizante  
 dessous antidérapant

cm			VE / unit	€ / pc.
60546	45 x 30	silber/schwarz / silver/black	6	5,50



60042  
 türküs, grün, weiß  
 turquoise, green, white

## PLACEMATS



### Tischset placemat mantelín set de table



**rutschhemmende Unterseite**  
slip resistant underside  
parte inferior antideslizante  
dessous antidérapant

	cm		VE / unit	€ / pc.
60543	45 x 30	silber / silver	6	5,50

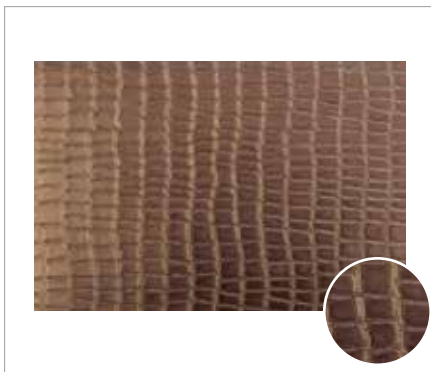

### Tischset „CROCO“ placemat mantelín set de table



**rutschhemmende Unterseite**  
slip resistant underside  
parte inferior antideslizante  
dessous antidérapant

	cm		VE / unit	€ / pc.
60536	45 x 30	kupfer / copper	6	5,50

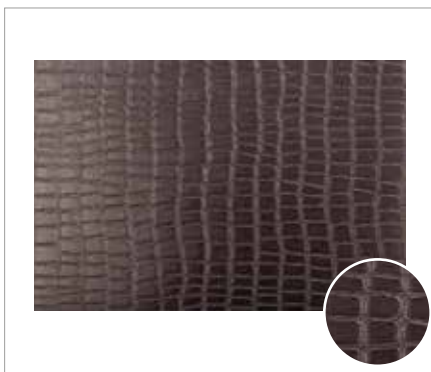

### Tischset „CROCO“ placemat mantelín set de table



**rutschhemmende Unterseite**  
slip resistant underside  
parte inferior antideslizante  
dessous antidérapant

	cm		VE / unit	€ / pc.
60537	45 x 30	braun / brown	6	5,50



60044  
Kunstleder, mit Naht rundherum  
imitation leather, with seam all around



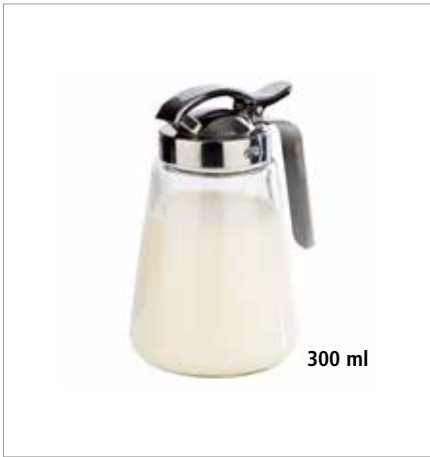

**Allzweckgießer**

pourer  
bote vertedor universal  
pot verseur universel

für Honig, Kaffeesahne, etc., Schraubdeckel aus Edelstahl

for honey, cream, etc., cover stainless steel

para miel, crema, etc., tapa inoxidable

pour le miel, le lait, la crème, etc., couvercle inox



	Ø cm	↑ cm	ltr.	€
00765	8,5	13,5	0,3	9,00

Ersatzglasbehälter / spare glass-container / contenedor de repuesto / récipient verre de rechange

	€
00768	1,80



**Allzweckgießer**

pourer  
dosificador  
doseur

Schraubdeckel aus Edelstahl und Kunststoff, mit Dosierklappe

cover stainless steel and plastic, with dosing flap

acero inoxidable y tapa plástico, con tubo dosificador

couvercle en inox et plastique, avec couvercle doseure



	Ø cm	↑ cm	ltr.	€
40488	8	12,5	0,25	6,80



**Milchkännchen, 4er Set**

milk/cream jugs, 4 pcs.  
pack de 4 jarritas para leche o crema  
pack de 4 crémiers

hochglanzpoliert, für Kaffeesahne, mit Griff, Inhalt à 25 ml

mirror polished, for coffee-cream, with handle, capacity à 25 ml

pulido brillante, para crema de café, con asa, capacidad 25 ml

poli brillant, avec anse, 25 ml



	Ø cm	↑ cm	pcs.	ltr.	€ / set
10321	3,5	3,5	4	0,025	15,0



**Mini-Milchkanne „SNACKHOLDER“ 4er Set**

mini milk can, 4 pcs.  
lechera en formato mini, set de 4  
pot à lait mini, set de 4



	Ø cm	↑ cm	ltr.	pcs.	€ / set
40640	4,5	5	0,08	4	16,40



5-tlg.  
5 pcs.

**Milch- und Zucker-Set**

milk and sugar set  
set de crema y azúcar  
set lait et sucre

5-teilig: Tablett, Milchkanne, Zuckerdose mit Deckel, Löffel, Akazienholz, Edelstahl beschichtet, schwarz

5 pcs.: tray, milk jug, sugar bowl with lid, spoon, acacia wood, stainless inox coated, black

set de 5: bandeja, jarra de leche, azucarero con tapa, cuchara, madera de acacia,

acero inoxidable revestimiento, negro

set de 5: plateau, pichet à lait, sucrier avec couvercle, cuillère, bois d'acacia, acier inox revêtement, noir



	cm	↑ cm	€ / set
00634	19 x 10	10,5	26,00

## SUGAR DISPENSERS



### Zuckerkuigel

sugar pot  
azucarero  
sucrier

hochglanzpoliert, mit Roldeckel  
mirror polished, rolltop cover  
pulido brillante, tapa abatible  
poli brillant, couvercle abattant



	Ø cm	↑ cm	€
00033	13,5	15	14,40



### Zuckerdosierer

sugar dispenser  
azucarero  
sucrier

Schraubdeckel aus Edelstahl, mit Dosierrohr  
cover stainless steel, with dosing tube  
tapa inoxidable y tubo, con tubo dosificador  
couvercle inox et tube doseur



	Ø cm	↑ cm	ltr.	€
40509	6	14,5	0,2	12,00



### Zuckerdosierer

sugar dispenser  
azucarero  
sucrier

mit Schraubverschluss, Dosierrohr  
cover and dosing tube  
con tapa y tubo dosificador  
couvercle avec tube doseur



	Ø cm	↑ cm	ltr.	€
40508	6,5	14,5	0,20	11,50



### Zuckerdosierer

sugar dispenser  
azucarero  
sucrier

Schraubdeckel aus Edelstahl / cover stainless steel / tapa inoxidable / couvercle inox



	Ø cm	↑ cm	ltr.	€
00766	8,5	15	0,3	5,50

Ersatzglasbehälter / spare glass-container / contenedor de repuesto / récipient verre de rechange

	€
00768	1,80



320 ml

**Zuckerdosierer**

sugar dispenser  
azucarero  
sucrier



**Schraubdeckel aus Edelstahl, mit Dosierrohr**

cover stainless steel, with dosing tube  
tapa inoxidable y tubo dosificador  
couvercle inoxydable et tube doseur

	∅ cm	↑ cm	ltr.	€
40506	7,5	17,0	0,32	5,40



250 ml

**Zuckerdosierer**

sugar dispenser  
azucarero  
sucrier



**Schraubdeckel aus Edelstahl, mit Dosierrohr**

cover stainless steel, with dosing tube  
tapa inoxidable y tubo, con tubo dosificador  
couvercle inox et tube doseur

	∅ cm	↑ cm	ltr.	€
40486	8	15	0,25	3,90



40490 150 ml

40494 250 ml

**Zuckerdosierer**

sugar dispenser  
azucarero  
sucrier



**Schraubdeckel aus Edelstahl, mit Dosierrohr**

cover stainless steel with dosing tube  
tapa inoxidable y tubo dosificador  
couvercle inox et tube doseur

	∅ cm	↑ cm	ltr.	€
40490	8,5	12	0,15	3,90
40494	8,0	15	0,25	3,90



320 ml

**Zuckerdosierer**

sugar dispenser  
azucarero  
sucrier



**Schraubdeckel mit Klappe aus Edelstahl, mit Dosierklappe**

cover stainless steel, with dosing flap  
tapa acero inoxidable, con tubo dosificador  
couvercle inox, avec couvercle doseur

	∅ cm	↑ cm	ltr.	€
40487	7,5	13,5	0,32	4,80



350 ml

**Zuckerdosierer „OLD FASHIONED“**

sugar dispenser  
azucarero  
sucrier



**Schraubdeckel mit Klappe aus Edelstahl, mit Dosierklappe**

cover stainless steel, with dosing flap  
tapa acero inoxidable, con tubo dosificador  
couvercle inox, avec couvercle doseur

	∅ cm	↑ cm	ltr.	€
40510	7,5	14	0,35	4,40

**NEW** SNUG



**Espressotasse „SNUG“**

espresso cup  
taza de espresso  
tasse à espresso



Porzellan, Griff: 2 cm / porcelain, handle: 2 cm / porcelana, asa: 2 cm / porcelaine, poignée: 2 cm

	Ø cm	↑ cm	litr.	Farbe / Colour	VE / unit	€/ pc.
16000	6	5,5	0,08		6	2,90
16001	6	5,5	0,08		6	2,90
16002	6	5,5	0,08		6	2,90



**Espresso-untertasse „SNUG“**

espresso saucer  
platillo de espresso  
soucoupe à espresso



Porzellan / porcelain / porcelana / porcelaine

	Ø cm	↑ cm		Farbe / Colour	VE / unit	€/ pc.
16009	11,5	2			6	2,80
16010	11,5	2			6	2,80
16011	11,5	2			6	2,80





**Kaffeetasse „SNUG“**

coffee cup  
taza de café  
tasse à café



Porzellan, Griff: 2 cm / porcelain, handle: 2 cm / porcelana, asa: 2 cm / porcelaine, poignée: 2 cm

	Ø cm	↑ cm	ltr.	Farbe / Colour	VE / unit	€ / pc.
16003	9,5	6	0,2		6	4,10
16004	9,5	6	0,2		6	4,10
16005	9,5	6	0,2		6	4,10



**Kaffeuntertasse „SNUG“**

coffee saucer  
platillo de café  
soucoupe à café



Porzellan / porcelain / porcelana / porcelaine

	Ø cm	↑ cm		Farbe / Colour	VE / unit	€ / pc.
16012	14,5	2,5			6	3,40
16013	14,5	2,5			6	3,40
16014	14,5	2,5			6	3,40



**Cappuccinotasse „SNUG“**

cappuccino cup  
taza de cappuccino  
tasse à cappuccino



Porzellan, Griff: 3 cm / porcelain, handle: 3 cm / porcelana, asa: 3 cm / porcelaine, poignée: 3 cm

	Ø cm	↑ cm	ltr.	Farbe / Colour	VE / unit	€ / pc.
16006	10,5	6,5	0,3		6	5,60
16007	10,5	6,5	0,3		6	5,60
16008	10,5	6,5	0,3		6	5,60



**Cappuccinountertasse „SNUG“**

cappuccino saucer  
platillo de cappuccino  
soucoupe cappuccino



Porzellan / porcelain / porcelana / porcelaine

	Ø cm	↑ cm		Farbe / Colour	VE / unit	€ / pc.
16015	15,5	2,5			6	3,80
16016	15,5	2,5			6	3,80
16017	15,5	2,5			6	3,80

**NEW** TWINZ



**Gläser, 2er Set „TWINZ“**

glasses, 2 pcs. set  
vasos, set de 2  
verres, set de 2



**doppelwandig, ideal für Espresso**  
glass, double-walled, ideal for espresso  
vidrio, doble pared, ideal para espresso  
verre, à double paroi, idéal pour l'espresso

	Ø cm	↑ cm	ltr.	pcs.	€/ set
10370	6	6,5	0,08	2	8,00



**Gläser, 2er Set „TWINZ“**

glasses, 2 pcs. set  
vasos, set de 2  
verres, set de 2



**doppelwandig, ideal für Kaffee oder Tee**  
glass, double-walled, ideal für coffee or tea  
vidrio, doble pared, ideal para café o té  
verre, à double paroi, idéal pour le café ou le thé

	Ø cm	↑ cm	ltr.	pcs.	€/ set
10371	8,5	8,5	0,23	2	10,00



**Gläser, 2er Set „TWINZ“**

glasses, 2 pcs. set  
vasos, set de 2  
verres, set de 2



**doppelwandig, ideal für Latte Macchiato**  
glass, double-walled, ideal for Latte Macchiato  
vidrio, doble pared, ideal para latte macchiato  
verre, à double paroi, idéal pour le latte macchiato

	Ø cm	↑ cm	ltr.	pcs.	€/ set
10372	8,5	14	0,38	2	12,00

**NEW** PERFECTION



**Sektglas „PERFECTION“**  
 champagne glass  
 copa de champán  
 flûte à champagne



	Ø cm	↑ cm	ltr.	VE / unit	€ / pc.
10540	5	23	0,19	12	6,00



**Weißweinglas „PERFECTION“**  
 white wine glass  
 copa de vino blanco  
 verre à vin blanc



	Ø cm	↑ cm	ltr.	VE / unit	€ / pc.
10541	8	21,5	0,32	12	7,00



**Rotweinglas „PERFECTION“**  
 red wine glass  
 copa de vino tinto  
 verre à vin rouge



	Ø cm	↑ cm	ltr.	VE / unit	€ / pc.
10542	10,5	21	0,6	12	8,00



# TABLE LAMPS



Die APS LED-Tischleuchten sind wiederaufladbare, kabellose, batteriebetriebene Leuchten. Ein Knopf an der Unterseite ermöglicht das Ein- und Ausschalten. Ausgestattet mit einem Dimmschalter, schaffen diese Leuchten ein perfektes Ambiente für Ihr Wohlbefinden und bieten bis zu 15-20 Stunden Betrieb mit einer einzigen Ladung. Die Leuchten sind sowohl für den Innen- als auch für den Außenbereich geeignet. Jede Leuchte wird mit einer Kontaktladestation geliefert; das Ladegerät und die Fernbedienung sind ebenfalls im Lieferumfang enthalten. Sie sind einfach aufzuladen und aufzubewahren, da sie magnetisch befestigt werden können, und verbrauchen wenig Strom.

The APS LED Table Lamps are rechargeable battery-powered cordless lamps. A "push" control on the bottom allows switching on/off. Equipped with a dimmer switch, these lamps create a perfect ambiance for you your well-being and offer up to 15-20 hours of operation on a single charge. The lamps are suitable for both indoor and outdoor use. Each lamp comes with a contact charging base; the battery charger and remote control are also included. They are easy to charge and store with magnetic connectors and low in LED power consumption.

Las lámparas de mesa LED de APS son lámparas inalámbricas recargables que funcionan con pilas. Un mando "push" situado en la parte inferior permite encenderlas y apagarlas. Equipadas con un regulador de intensidad, estas lámparas crean un ambiente perfecto para su bienestar y ofrecen hasta 15-20 horas de funcionamiento con una sola carga. Las lámparas son perfectas para su uso tanto en el interior como para el exterior. Cada lámpara viene con una estación de carga por contacto; el cargador de pilas y el mando a distancia también están incluidos. Son fáciles de cargar y almacenar gracias a sus conectores magnéticos y tienen un bajo consumo de energía LED.

Les lampes de table LED d'APS sont des lampes rechargeables, sans fil et fonctionnant sur piles. Un bouton poussoir ("push") situé sur le dessous permet de les allumer et de les éteindre. Equipées d'un variateur de lumière, ces lampes créent une ambiance parfaite pour votre bien-être et offrent jusqu'à 15-20 heures de fonctionnement avec une seule charge. Les lampes conviennent aussi bien à l'intérieur qu'à l'extérieur. Chaque lampe est livrée avec une station de recharge à contact ; le chargeur de batterie et la télécommande sont également inclus. Elles sont faciles à charger et à ranger grâce à des connecteurs magnétiques et consomment peu d'énergie.





Tischleuchte „MERLE“  
table lamp  
lámpara de mesa  
lampe de table



inklusive Ladestation, USB Ladekabel (ohne Netzteil), Fernbedienung inkl. Batterie

charging station included, USB charging cable (without mains adapter), remote control incl. battery  
con estación de carga, cable de carga USB (sin adaptador de red), mando a distancia incl. batería  
avec station de charge, câble de charge USB (sans bloc d'alimentation), télécommande avec batterie

	Ø cm	↑ cm	Farbe / Colour	€
17000	11	30,5		66,00
17001	11	30,5		66,00
17002	11	30,5		66,00



# TABLE LAMPS



**Tischleuchte „FINN“**  
 table lamp  
 lámpara de mesa  
 lampe de table



**inklusive Ladestation, USB Ladekabel (ohne Netzteil), Fernbedienung inkl. Batterie**  
 charging station included, USB charging cable (without mains adapter), remote control incl. battery  
 con estación de carga, cable de carga USB (sin adaptador de red), mando a distancia incl. batería  
 avec station de charge, câble de charge USB (sans bloc d'alimentation), télécommande avec batterie

	Ø cm	↑ cm	Farbe / Colour	€
17006	13	25		49,00



**Tischleuchte „NIELS“**  
table lamp  
lámpara de mesa  
lampe de table

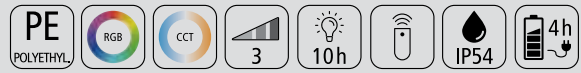

**inklusive Ladestation, USB Ladekabel (ohne Netzteil), Fernbedienung inkl. Batterie**

charging station included, USB charging cable (without mains adapter), remote control incl. battery  
con estación de carga, cable de carga USB (sin adaptador de red), mando a distancia incl. batería  
avec station de charge, câble de charge USB (sans bloc d'alimentation), télécommande avec batterie

	Ø cm	↑ cm	Farbe / Colour	€
17007	11,5	16		36,00



**Tischleuchte „CLEO“**  
table lamp  
lámpara de mesa  
lampe de table



**inklusive Ladestation, USB Ladekabel (ohne Netzteil), Fernbedienung inkl. Batterie**

charging station included, USB charging cable (without mains adapter), remote control incl. battery  
con estación de carga, cable de carga USB (sin adaptador de red), mando a distancia incl. batería  
avec station de charge, câble de charge USB (sans bloc d'alimentation), télécommande avec batterie

	Ø cm	↑ cm	Farbe / Colour	€
17003	12	30,5		69,00
17004	12	30,5		69,00
17005	12	30,5		69,00

## TABLE LAMPS

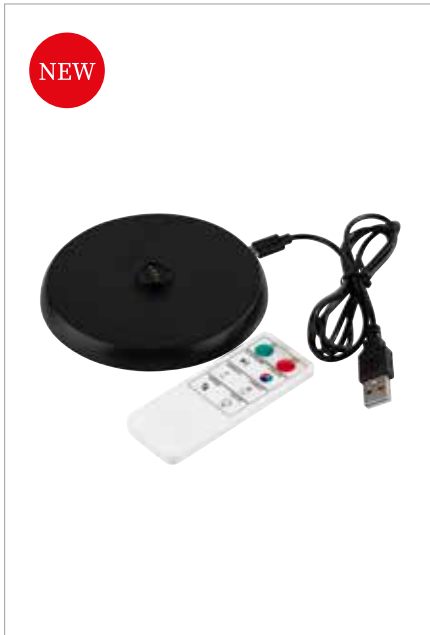

NEW

### Ersatzteilset für Tischleuchten

spare parts set for table lamp  
set de repuesto para lámpara  
set de pièces de rechange

Set bestehend aus:

- Ladeplatte
- Kabel (USB A auf USB C)
- Fernbedienung inklusive Batterie

set consisting of:

- charging plate
- cable (USB A auf USB C)
- remote control incl. battery

set compuesto por:

- placa de carga
- cable (USB A a USB C)
- mando a distancia incl. batería

set composé de:

- plaque de chargement
- câble (USB A vers USB C)
- télécommande avec batterie

ABS  
KUNSTSTOFF

	cm	↑ cm	Farbe / Colour	€
17023	11	1	■	7,90



NEW

### Rohre für Ladestation

tubes for charging station  
tubos para estación de carga  
tubes pour station de charge

passend zu Ladestation

suitable for charging station

para estación de carga

pour station de charge

METALL

	Ø cm	↑ cm	fits to	pcs.	Farbe / Colour	€
17022	2	43	17020, 17021	4	■	9,00



NEW

### Ladestation, 6-fach

charging station, 6-fold  
estación de carga, 6 vías  
station de charge, 6 places

Platzsparend und transportsicher!

Die Tischleuchten werden auf die magnetischen Kontakte der Ladestation gestellt und können nicht von der Station fallen – kippsicherer Transport! Zwei Ladestationen können mit Hilfe von vier Verbindungsröhren (Art.-Nr. 17022) als Doppeldecker-Ladestation verbunden werden – mit einem Kabel können bis zu 12 Leuchten gleichzeitig geladen werden.

Space-saving and transport-safe!

The table lamps are placed on the magnetic contacts of the charging station and cannot fall off the station - tilt-proof transport! Two charging stations can be connected as a double-decker charging station using four connecting tubes (art. no. 17022) - up to 12 lights can be charged simultaneously with one cable.

Ahorro de espacio y transporte seguro.

Las lámparas de mesa se colocan en los contactos magnéticos de la estación de carga y no pueden caerse de la estación - ¡transporte antivuelco! Se pueden conectar dos estaciones de carga como estación de carga de dos pisos utilizando cuatro tubos de conexión (ref. 17022) - se pueden cargar hasta 12 lámparas simultáneamente con un solo cable.

Peu encombrante et sûre pour le transport !

Les lampes de table sont placées sur les contacts magnétiques de la station de recharge et ne peuvent pas tomber de la station - transport sans risque de basculement ! Deux stations de charge peuvent être reliées à l'aide de quatre tubes (art. n° 17022) de liaison pour former une station de charge à deux étages - un câble permet de charger jusqu'à 12 lampes simultanément.

ABS  
KUNSTSTOFF

	cm	↑ cm	Farbe / Colour	€
17020	43 x 31,5	5	■	138,00



NEW



**Ladestation, 15-fach**  
charging station, 15-fold  
estación de carga, 15 vías  
station de charge, 15 places



**Platzsparend und transportsicher!**

Die Ladestation passt maßlich perfekt auf den Servier-/Transportwagen (Art.-Nr. 11977). Die Tischleuchten werden auf die magnetischen Kontakte der Ladestation gestellt und können nicht von der Station fallen – kippsicherer Transport! Zwei Ladestationen können mit Hilfe von vier Verbindungsrohren (Art.-Nr. 17022) als Doppeldecker-Ladestation verbunden werden – mit einem Kabel können bis zu 30 Leuchten gleichzeitig geladen werden.

Space-saving and transport-safe!

The charging station fits perfectly on the serving/transport trolley (art. no. 11977). The table lamps are placed on the magnetic contacts of the charging station and cannot fall off the station - tilt-proof transport! Two charging stations can be connected as a double-decker charging station using four connecting tubes (art. no. 17022) - up to 30 lights can be charged simultaneously with one cable.

Ahorro de espacio y transporte seguro.

La estación de carga encaja perfectamente en el carro de servicio/transporte (ref. 11977). Las lámparas de mesa se colocan en los contactos magnéticos de la estación de carga y no pueden caerse de la estación - ¡transporte antivuelco! Se pueden conectar dos estaciones de carga como estación de carga de dos pisos utilizando cuatro tubos de conexión (ref. 17022) - se pueden cargar hasta 30 lámparas simultáneamente con un solo cable.

Peu encombrante et sûre pour le transport !

Les dimensions de la station de chargement s'adaptent parfaitement au chariot de service/transport (art. n° 11977). Les lampes de table sont placées sur les contacts magnétiques de la station de recharge et ne peuvent pas tomber de la station - transport sans risque de basculement ! Deux stations de charge peuvent être reliées à l'aide de quatre tubes (art. n° 17022) de liaison pour former une station de charge à deux étages - un câble permet de charger jusqu'à 30 lampes simultanément.

	cm	↑ cm	Farbe / Colour	€
17021	75 x 43	5	■	230,00



**Servier- / Transportwagen**  
service trolley  
carro de servicio  
chariot de service



mit 2 Borden, Bordmaße 83 x 51 cm, Abstand zwischen den Borden 56 cm, Tragfähigkeit 80 kg, 4 Lenkrollen, davon 2 feststellbar, Lieferung demontiert, einfache Montage  
with 2 trays, trays 83 x 51 cm, size between the trays 56 cm, total load capacity 80 kg, 4 wheels with 2 brakes, unassembled, simple assembly

con 2 bandejas de acero inoxidable mate, 83 x 51 cm, la medida entre bandejas 56 cm, capacidad total 80 kg, 4 ruedas, con 2 frenos, construcción robusta, montaje fácil  
2 niveaux, 83 x 51 cm chacun, distance entre niveaux 56 cm, capacité maxi 80 kg au total, 4 roues dont 2 avec frein, construction robuste, montage facile

	cm	↑ cm	€
11977	91 x 59	93	146,00



**Windlichter „ELEMENT“, 2er Set**

wind lights, 2 pcs.  
portavelas antiviento, set de 2  
porte-bougies anti-vent, set de 2

**Beton, Gläser klar, möbelschonende Unterseite**  
concrete, glass clear, furniture-friendly underside  
hormigón, vidrio transparente, base anti rayaduras  
bèton, verre transparente, revêtement antirayures



	Ø cm	↑ cm	pcs.	€/ set
03038	6	8	2	13,00

**Ersatzglas / spare glass / vidrio de recambio solo / verre de rechange transparent, seul**

	Ø cm	↑ cm	€
03098	6	5	2,90



**Windlicht „ELEMENT“**

wind light  
porta vela  
porte-bougie

**Beton, Glas klar, möbelschonende Unterseite**  
concrete, glass clear, furniture-friendly underside  
hormigón, vidrio transparente, base anti rayaduras  
bèton, verre transparente, revêtement antirayures



	Ø cm	↑ cm	€
03039	7,5	13	9,80

**Ersatzglas / spare glass / vidrio de recambio solo / verre de rechange transparent, seul**

	Ø cm	↑ cm	€
03099	7,5	9	3,60



**Vase mit Glaseinsatz „ELEMENT“**

flower vase with glass insert  
florero con tubo de cristal  
vase soliflor avec verre

**Beton, Glas klar, möbelschonende Unterseite, inkl. 2 Ersatzgläsern**  
concrete, clear glass, furniture-friendly underside, incl. 2 spare glasses  
hormigón, cristal incoloro, base anti rayaduras, incl. 2 tubos de repuesto  
béton, verre transparente revêtement antirayures y compris 2 verres de rechange



	cm	↑ cm	ml	€
04010	10 x 4,5	12,5	25	7,30

**Ersatzglas / spare glass / tubo de recambio / verre de rechange**

	Ø cm	↑ cm	ml	€
04011	2,5	11	25	1,40



**Vase**

flower vase  
florero  
vase soliflor

**Edelstahl-Look, Zinkdruckguss, vernickelt, lackiert, anlaufgeschützt, schwere Ausführung**  
stainless steel look, heavy zink alloy, nickel plated, laquered  
aspecto acero, acabado satinado, alta calidad  
aspect inox, fini poli mat, bonne qualité



	Ø cm	↑ cm	kg	€
04015	4,0	16,5	0,17	15,00

# MENU HOLDERS



zum Einschieben der Speisekarten – schneller Austausch jederzeit möglich!  
for inserting the menus - quick exchange possible at any time!



Der Kartenhalter ist völlig unkompliziert zu handhaben, denn er verfügt über eine Vorrichtung, in die die Karten einfach eingeschoben und schnell ausgetauscht werden können.

The menu holder is completely uncomplicated to handle, because it has a device into which the cards can simply be inserted and quickly exchanged.

El uso del porta menús es totalmente sencillo, ya que dispone de un dispositivo en el que simplemente se introducen las tarjetas y se intercambian rápidamente.

L'utilisation du porte-cartes est très simple, car il dispose d'un dispositif dans lequel les cartes peuvent être simplement insérées et rapidement échangées.



2 tlg.  
2 pcs.

DIN A6

71521

## Kartenhalter 2-teilig

menu holder, 2 pcs.  
porta menús, set de 2  
porte-cartes, set de 2

Fuß aus Edelstahl, Menühalter aus Acryl  
stainless steel base, menu holder made of acrylic  
base de acero inoxidable, porta menús acrílico  
base en acier inox, porte-cartes en acrylique



	cm	↑ cm		€ / set
71521	10,5 x 7	17	stainless steel	11,00
71527	10,5 x 7	17	black	11,00



2 tlg.  
2 pcs.

DIN A5

71522

## Kartenhalter 2-teilig

menu holder, 2 pcs.  
porta menús, set de 2  
porte-cartes, set de 2

Fuß aus Edelstahl, Menühalter aus Acryl  
stainless steel base, menu holder made of acrylic  
base de acero inoxidable, porta menús acrílico  
base en acier inox, porte-cartes en acrylique



	cm	↑ cm		€ / set
71522	15 x 7	23	stainless steel	13,60
71528	15 x 7	23	black	13,60



2 tlg.  
2 pcs.

DIN A4

71523

## Kartenhalter 2-teilig

menu holder, 2 pcs.  
porta menús, set de 2  
porte-cartes, set de 2

Fuß aus Edelstahl, Menühalter aus Acryl  
stainless steel base, menu holder made of acrylic  
base de acero inoxidable, porta menús acrílico  
base en acier inox, porte-cartes en acrylique



	cm	↑ cm		€ / set
71523	21 x 7	32	stainless steel	16,00
71529	21 x 7	32	black	16,00

## MENU HOLDERS



### Mini Staffelei, 2 teilig

easel mini, 2 pcs.  
caballete mini, set de 2  
chevale mini, set de 2



**Ständer aus Akazienholz, Schild kann senkrecht oder waagrecht verwendet werden**

acacia wood stand, sign can be used vertically or horizontally

soporte de madera de acacia, el cartel se puede utilizar vertical u horizontalmente

support en bois d'acacia, le panneau peut être utilisé verticalement ou horizontalement

	cm	↑ cm	€/ set
71520	13,5 x 10,0	19	8,90
71531	19,5 x 15,0	24	9,90



waagrecht  
horizontal



senkrecht  
vertical



71490 Kreide-Marker  
chalk marker

Inhalt ohne Stift  
content without pen



### Kartenhalter „ELEMENT“, 2 teilig

menu holder, 2 pcs.  
soporte de tarjeta de menú, set de 2  
porte-cartes de menu, set de 2



**Fuß aus Beton, Menühalter aus Acryl**

concrete base, acrylic menu sign / holder

base de hormigón, letrero de menú acrílico

socle en béton, plaque de menu en acrylique

	cm	↑ cm	€/ set
71496	11,5 x 4,5	10	13,10
71497	15,5 x 6,5	26	20,90



### Kartenhalter-Set

card holder set  
portatarjetas, set  
porte-cartes, set



**18-teilig: 6 Kartenhalter 4 x 2,5 cm + 12 Kunststoff-Beschriftungskarten 10 x 6 cm**

18 pcs.: 6 card holder 4 x 2,5 cm + 12 plastic cards of inscription 10 x 6 cm

set de 18: 6 soportes 4 x 2,5 cm + 12 tarjetas de plástico 10 x 6 cm

set de 18: 6 supports 4 x 2,5 cm + 12 étiquettes en plastique 10 x 6 cm

	cm	€/ set
00022	4 x 2,5	13,30





**Kartenhalter „WÜRFEL“, 4er Set**

table stands, 4 pcs.  
soporte de mesa, set de 4  
porte-étiquettes, set de 4



**inklusive 20 weiße Beschriftungskarten ca. 10 x 8 cm, mehrfach beschriftbar**  
including 20 white labels 10 x 8 cm, multiple inscribable  
incluye 20 etiquetas blancas 10 x 8 cm, inscribable múltiple  
20 étiquettes blanches incluses 10 x 8 cm, inscriptible multiple

	cm		pcs.	€ / set
00078	3 x 3 x 3		4	11,00



**Tafelhalter / Schild**

slate sign  
caballete de mesa, pizarra  
plaque signalétique avec support



	cm	↑ cm	pcs.	€
00060	12 x 4	7	1	7,80



**Kartenhalter, 2er Set**

table stands, 2 pcs.  
portatarjetas, set de 2  
porte-cartes, set de 2



**inklusive 30 Beschriftungskarten ca. 10 x 8 cm (15 x weiß + 15 x schwarz)**  
including 30 labels 10 x 8 cm (15 x white + 15 x black)  
incluye 30 tarjetas 10 x 8 cm (15 x blanco + 15 x negro)  
inclut 20 étiquettes 10 x 8 cm (15 x blanc + 15 x noir)

	cm	↑ cm	pcs.	€ / set
71495	8 x 3,5	6	2	8,20

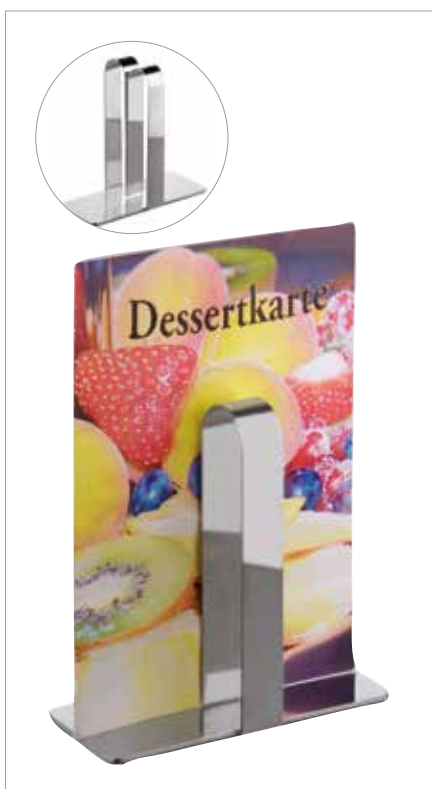

**Tischkartenhalter**

table stand  
soporte de mesa  
support de table  
**möbelschonende Unterseite**  
non-scratching undersurface  
con base antirrayaduras  
avec revêtement antirayures



	cm	↑ cm		€
00071	14 x 5,5	14		17,20

## MENU HOLDERS



### Schilderhalter „FLEXIBEL“

sign holder  
soporte para cartelito  
support pour menu de table



**biegsamer Draht mit zwei Klemmen, extrem flexibel, die Klemmen lassen sich weit öffnen**

bedable metal coil adds visual interest, two metal clip open

metal cromado flexible, 2 pinzas con gran apertura

métal chromé, flexible, 2 pinces à grande ouverture

	→ cm		€
71470	12	ohne Schilder / without signs sin cartelitos / sans étiquette	3,70
71471	23	ohne Schilder / without signs sin cartelitos / sans étiquette	4,40
71480	12	inkl. 10 Schilder 11879 / incl. 10 signs 11879 con 10 cartelitos 11879 / avec 10 étiquettes 11879	9,30

**Schilder, 10er Set / signs, 10 pcs. / set de 10 cartelitos / set de 10 étiquettes**

	cm	€ / set
11879	7,7 x 5,2	5,20
12879	5,0 x 3,0	4,90



### Tischaufsteller 2er Set

table stands, 2 pcs.  
caballetes de mesa, set de 2  
chevalets de table, set de 2



	cm	↑ cm		pcs.	€ / set
00017	5,5 x 5	3,5	reserviert	2	4,20
00013	5,5 x 5	3,5	reserved	2	4,20
00572	5,5 x 5	3,5	no smoking	2	7,20



### Beschriftungsetiketten

labeling labels  
etiquetas  
étiquettes



**12 Bögen mit je 6 Motiven, selbstklebend, mit wasserlöslichem Stift beschreibbar**

12 sheets includes 6 self-adhesive and removable labels, use regular chalkboard markers and wipe clean with a damp cloth

12 hojas, cada una con 6 motivos autoadhesivos, se pueden marcar con un rotulador lavable con agua

12 feuilles chacune avec 6 motifs autoadhésifs, on peut écrire avec un stylo lavable à l'eau

	cm	Farbe / Colour	€
00069	8,0 x 4,5	■	10,00



### Kreide-Marker, Stärke 2 mm, 2er Set

chalk marker, 2 pcs.  
rotulador de tiza, set de 2  
marqueur a la craie liquide, set de 2



**Zum Gestalten und Beschriften von Tafeln, Glas und fast allen geschlossenen Oberflächen, deckende Flüssigkreide auf Wasserbasis, feucht abwischbar**

For decorating and writing on boards, glass and almost all non-porous surfaces, opaque water-based liquid chalk, wet-wipeable

Rotuladores para pizarra de tiza líquida para decorar y escribir sobre pizarras, cristales y casi todas las superficies no porosas. Tiza líquida opaca al agua que se pueda borrar con un trapo

Pour décorations et inscriptions sur tableaux, verre et presque toutes les surfaces non poreuses, craie liquide opaque à base d'eau, effaçable avec un chiffon humide

	Ø cm	↑ cm	Farbe / Colour	pcs.	€ / set
71490	1	13	■	2	6,20
71491	1	13	■	2	6,20



**Kartenhalter, 4er Set**

table stands, 4 pcs.  
portatarjetas, set de 4  
porte-cartes, set de 4

hochglanzpoliert, inklusive 20 schwarze Beschriftungskarten aus Polypropylen  
mirror polished, including 20 black cards made of polypropylene  
pulido brillante, incluye 20 tarjetas negras de polipropileno  
poli miroir, inclut 20 étiquettes noires en polypropylène



	Ø cm	↑ cm	pcs.	Farbe / Colour	€/ set
71510	5	10,5	4	stainless steel	20,90
71513	5	15,5	4	stainless steel	22,10
71516	5	20,5	4	stainless steel	24,10



**Kartenhalter, 4er Set**

table stands, 4 pcs.  
portatarjetas, set de 4  
porte-cartes, set de 4

hochglanzpoliert, inklusive 20 schwarze Beschriftungskarten aus Polypropylen  
mirror polished, including 20 black cards made of polypropylene  
pulido brillante, incluye 20 tarjetas negras de polipropileno  
poli miroir, inclut 20 étiquettes noires en polypropylène



	Ø cm	↑ cm	pcs.	Farbe / Colour	€/ set
71512	5	10,5	4	gunmetal	24,10



**Beschriftungskarten, 10er Set**

designation cards, 10 pcs.  
tarjetas, set de 10  
étiquettes, set de 10



	cm	✂ mm	pcs.	€
00037	7,5 x 5	0,4	10	5,20



**Bankettkartenständer**

menu stand / table number  
porta-etiqueta o carta de sobremesa  
porte-étiquette de table, porte-menu, ou n° de table

hochglanzpoliert, schwere Qualität  
mirror polished, heavy gauge  
pulido brillante, alta calidad  
poli brillant, belle qualité



	Ø cm	↑ cm	€
71460	7,5	18,5	8,90
71461	7,5	29	11,50



**Tischkartenhalter, 4er Set**

table stands, 4 pcs.  
pinzas porta-etiquetas, set de 4  
porte-étiquettes à pince, set de 4

hochglanzpoliert, schwerer Fuß, inklusive 20 weiße Beschriftungskarten  
mirror polished, heavy foot, including 20 white labels  
pulido brillante, incluye 20 etiquetas en blanco  
poli brillant, inclut 20 étiquettes blanches



	Ø cm	↑ cm	pcs.	€/ set
00070	4	10	4	21,80

## MENU HOLDERS



### Tischaufsteller, 10er Set

table stands, 10 pcs.  
caballes de mesa, set de 10  
chevalets de table, set de 10



#### Ecken abgerundet

corners rounded  
esquinas redondeadas  
coins arrondies

	cm	↑ cm	pcs.	€/ set
00011	7,5 x 3,5	5	10	7,40
00012	10,5 x 6	6,5	10	8,50



### Kartenhalter, 2er Set

card holder, 2 pcs.  
soporte de mesa, set de 2  
support de table, set de 2



#### inklusive 40 Beschriftungskarten, durch Magnete einfach zusammenklappbar

including 40 cards, easily foldable with magnets  
incluye 40 tarjetas, fácil de plegar, con imanes  
inclut 40 étiquettes, fácil à plier, avec aimants

	cm	↑ cm	pcs.	€/ set
00076	9 x 3	5,5	2	17,70



### Kartenhalter, 2er Set

menu holder, 2 pcs.  
porta cartas de mesa, set de 2  
supports pour menu de table, set de 2



#### Rubberwood / rubber wood / madera de goma / bois d'hévéa

	cm	↑ cm	pcs.	€/ set
00023	8,5 x 6	4,5 / 8,5	2	8,30



### Kartenhalter, 2er Set

menu holder, 2 pcs.  
porta cartas de mesa, set de 2  
porte-menus de table, set de 2



**matt poliert**  
matt polished  
pulido mate  
poli mat

	cm	↑ cm	pcs.	€/ set
00021	8,5 x 4	4 / 8,5	2	9,70



**Tischkartenhalter**  
table stand  
soporte-carta para la mesa  
support pour menu de table



**matt poliert**  
matt polished  
pulido mate  
poli mat

	cm	↑ cm	pcs.	€
00030	8 x 7,0	2	1	3,10
00036	6 x 4,5	4	1	2,30



**Kartenhalter-Set, 4er Set**



table stands, 4 pcs.  
portatarjetas, set de 4  
porte-cartes, set de 4  
**inklusive 30 Beschriftungskarten (15 x weiß + 15 x schwarz)**  
including 30 labels ( 15 x white + 15 x black)  
incluye 30 tarjetas (15 x blanco + 15 x negro)  
includ 20 étiquettes (15 x blanc + 15 x noir)

	cm	↑ cm	pcs.	€ / set
71492	3 x 3	3	4	8,90
71493	3 x 3	3	4	8,90
71494	3 x 3	12	4	9,70



**Kartenhalter, 4er Set**  
table stands, 4 pcs.  
soportes de mesa, set de 4  
upport de table, set de 4



**inklusive 20 weiße Beschriftungskarten ca. 10 x 8 cm**  
including 20 white labels 10 x 8 cm  
incluye 20 etiquetas blancas 10 x 8 cm  
20 étiquettes blanches incluses 10 x 8 cm

	cm	↑ cm	pcs.	Farbe / Colour	€ / set
00074	3 x 3	12	4		9,70



**Kartenhalter, 4er Set**  
table stands, 4 pcs.  
soportes de mesa, set de 4  
support de table, set de 4

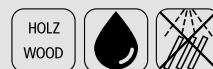

**Rubberwood, inklusive 20 weiße Beschriftungskarten ca. 10 x 8 cm**  
rubber wood, including 20 white labels 10 x 8 cm  
madera de goma, incluye 20 etiquetas blancas 10 x 8 cm  
bois d'hévéa, 20 étiquettes blanches incluses 10 x 8 cm

	cm	↑ cm	pcs.	Farbe / Colour	€ / set
00700	2,5 x 2,5	12	4		8,20

## CUTLERY BINS

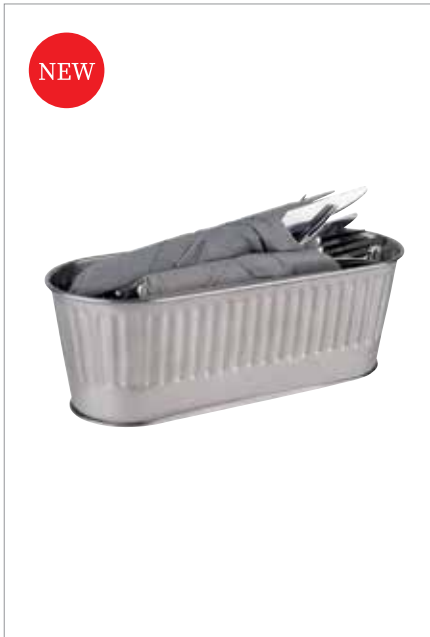

### Besteckbehälter / Korb

cutlery bin / basket  
 porta cubiertos / cesta  
 range-couverts / corbeille  
**matt poliert, Boden: 29 x 8,5 cm**  
 matt polished, base: 29 x 8,5 cm  
 pulido mate, base: 29 x 8,5 cm  
 poli mat, fond: 29 x 8,5 cm



	cm	↑ cm	ltr.	Farbe / Colour	€
11752	29,5 x 12	10	2		11,50



Präsentationsmöglichkeit  
 presentation example



### Besteckbehälter / Korb

cutlery bin / basket  
 porta cubiertos / cesta  
 range-couverts / corbeille  
**Boden: 29 x 8,5 cm**  
 base: 29 x 8,5 cm  
 base: 29 x 8,5 cm  
 fond: 29 x 8,5 cm



	cm	↑ cm	ltr.	Farbe / Colour	€
11753	29,5 x 12	10	2		13,00



Präsentationsmöglichkeit  
 presentation example

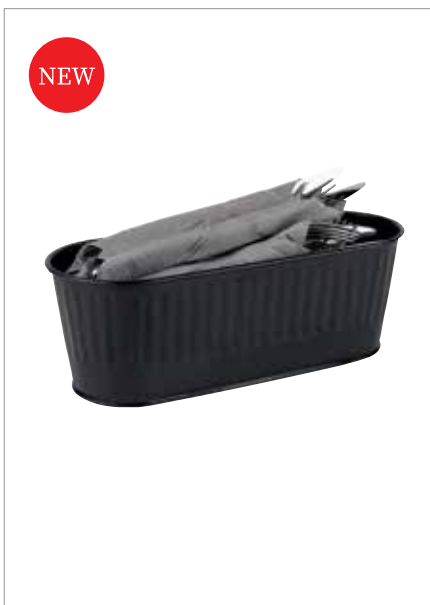

### Besteckbehälter / Korb

cutlery bin / basket  
 porta cubiertos / cesta  
 range-couverts / corbeille  
**Boden: 29 x 8,5 cm**  
 base: 29 x 8,5 cm  
 base: 29 x 8,5 cm  
 fond: 29 x 8,5 cm



	cm	↑ cm	ltr.	Farbe / Colour	€
11754	29,5 x 12	10	2		13,00



Präsentationsmöglichkeit  
 presentation example

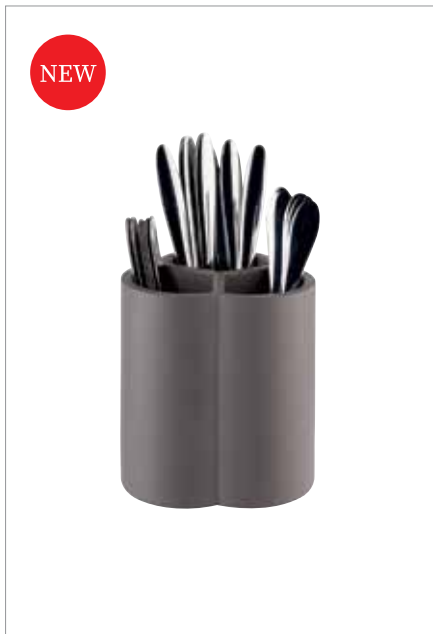

**Besteckbehälter „ELEMENT“**

cutlery bin  
porta cubiertos  
range-couverts



**möbelschonende Unterseite, 3 Fächer, Bodeneinlagen aus Silikon, zum Schonen der Messerspitzen**

furniture-friendly underside, 3 compartments, silicone insert to protect the knife tips  
con base anti rayaduras, 3 compartimentos, inserto de silicona para proteger los cuchillos  
avec revêtement antirayures, 3 compartiments, insert en silicone pour protéger les couteaux

	cm	↑ cm	Farbe / Colour	€
11750	13 x 13	14,5		18,00



möbelschonende Unterseite  
furniture-friendly underside



**Besteckbehälter „DART“**

cutlery bin  
porta cubiertos  
range-couverts



**3 Fächer, Bodeneinlagen aus Silikon, zum Schonen der Messerspitzen**

3 compartments, silicone insert to protect the knife tips  
3 compartimentos, inserto de silicona para proteger los cuchillos  
3 compartiments, insert en silicone pour protéger les couteaux

	Ø cm	↑ cm	Farbe / Colour	€
11755	12	25		14,00



Präsentationsmöglichkeit  
presentation example



**Besteckbehälter „ELEMENT“**

cutlery bin  
recipiente para cubiertos  
récipients pour couverts

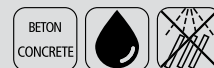

**mit Abflussloch, mit Besteck Logo, Bodeneinlagen aus Silikon zum Schonen des Bestecks, möbelschonende Unterseite**

with drain hole, with cutlery logo, silicone floor inserts for saving the points of knives, furniture-friendly underside  
con orificio de drenaje, con logotipo de cubertería, soporte de silicona para proteger las puntas de los cuchillos, con base antirrayaduras  
avec le trou de drainage, avec le logo de coutellerie, insert de silicone pour protéger les pointes des couteaux, avec base revêtue antirayures

	Ø cm	↑ cm		€
00018	11	14		17,00

## CUTLERY BINS



### Besteckbehälter, drehbar

cutlery bin, rotatable  
porta cubiertos, giratorio  
range-couverts, rotatif

innen: mattiert, inklusive herausnehmbarem  
Einteiler (3 Fächer), möbelschonende Unterseite

inside: matt finish, including removable, divider (3 compartments),  
furniture-friendly underside, Silicone base insert

interior: mate, con separador extraíble  
(3 compartimentos), con base anti rayaduras, inserto de silicona

intérieur: mat, avec compartiment amovible  
(3 compartiments), base revêtement antirayures, insert en silicone

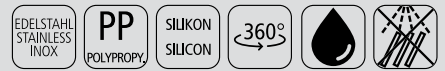

	Ø cm	↑ cm	Farbe / Colour	€
11747	13	16,5		20,00
11748	13	16,5		20,00



### Besteckköcher

cutlery basket  
cesta para cubiertos  
corbeille à couverts

Kunststoff weiß / white plastic / plástico blanco / plastique blanc



	Ø cm	↑ cm	€
11998	9,5	13,5	2,90

matt poliert / matt polished / pulido mate / poli mat

	Ø cm	↑ cm	€
11999	9,5	13,5	8,00



### Tischreste-/Besteckbehälter „TOP CHROME“

table waste bin / cutlery bin  
papelera de sobremesa / recipiente para cubiertos  
poubelle de table / récipients pour couverts

mit verchromten Rand / with chrome plated ring / con anillo cromado / avec bord chromé



	Ø cm	↑ cm	litr.	Farbe / Colour	€
00025	13	15	1		8,00
00026	13	15	1		8,00



### Tischreste-/Besteckbehälter „BASE CHROME“

table waste bin / cutlery bin  
papelera de sobremesa / recipiente para cubiertos  
poubelle de table / récipients pour couverts

mit verchromten Boden / with chrome bottom / con base cromada / avec base chromée



	Ø cm	↑ cm	litr.	Farbe / Colour	€
00019	13	15	1,3		8,00
00020	13	15	1,3		8,00





**Besteckkorb „ECONOMIC“**  
cutlery dispenser  
dispensador de cubiertos  
corbeille à couverts



	Ø cm	↑ cm	Farbe / Colour	€
40130	12	15		4,80
40007	12	15		4,80
40012	12	15		4,80
40013	12	15		4,80



**Besteckkorb „ECONOMIC“**  
cutlery dispenser  
dispensador de cubiertos  
corbeille à couverts



	cm	↑ cm	Farbe / Colour	€
40131	27 x 10	4,5		4,80
40009	27 x 10	4,5		4,80
40010	27 x 10	4,5		4,80
40011	27 x 10	4,5		4,80



**Besteckbehälter**  
cutlery bin  
recipiente para cubiertos  
récipients pour couverts



**Behälter aus Edelstahl, matt poliert**  
container made of stainless steel, matt polished  
contenedor de acero inoxidable, pulido mate  
conteneur en acier inox, poli mat

	Ø cm	↑ cm	€
11921	10	10,0	8,60
11922	12	13,5	11,20

## WASTE BINS



NEW

### Tischrestehälter

table garbage bin  
papelera de sobremesa  
poubelle de table



**Farbe: whisper white, abnehmbarer Schwingdeckel, mit Bajonettverschluss**

colour: whisper white, removable swing cover, with bayonet lock

color: blanco susurro, tapa basculante desmontable, con cierre de bayoneta

couleur: blanc chuchoté, couvercle basculant démontable, avec fermeture à baïonnette

	Ø cm	↑ cm	ltr.	Farbe / Colour	€
40801	12	17	1,2		19,00



NEW

### Tischrestehälter

table garbage bin  
papelera de sobremesa  
poubelle de table



**Farbe: smoke green, abnehmbarer Schwingdeckel, mit Bajonettverschluss**

colour: smoke green, removable swing lid, with bayonet lock

color: smoke green, tapa abatible extraíble, con cierra de bayoneta

couleur: smoke green, couvercle basculant amovible, verrouillage par baïonnette

	Ø cm	↑ cm	ltr.	Farbe / Colour	€
40802	12	17	1,2		19,00



NEW

### Tischrestehälter

table garbage bin  
papelera de sobremesa  
poubelle de table



**schwarz, abnehmbarer Schwingdeckel, mit Bajonettverschluss**

black, removable swing cover, with bayonet lock

negro, tapa basculante desmontable, con cierre de bayoneta

noir, couvercle basculant démontable, avec fermeture à baïonnette

	Ø cm	↑ cm	ltr.	Farbe / Colour	€
40800	12	17	1,2		19,00



00029

### Tischrestehälter

table garbage bin  
papelera de sobremesa  
poubelle de table



**matt poliert, abnehmbarer Schwingdeckel, mit Bajonettverschluss**

matt polished, swing cover, cover removable, with bayonet lock

pulido mate, tapa basculante desmontable, con cierre de bayoneta

poli mat, couvercle basculant démontable, avec fermeture à baïonnette

	Ø cm	↑ cm	ltr.	Farbe / Colour	€
00029	12	17	1,2		19,00
00027	10	13	0,7		13,90



**Table Caddy „COUNTRY STYLE“**

table barrel  
caddy de mesa  
caddy de table



**cooler Country-Style, nicht für den direkten Kontakt mit Lebensmittel verwendbar**  
condiment and cutlery holders or even for food presentation, the mini barrels should not come into contact with food, they should be lined with our greaseproof paper  
estilo campestre, no aptos para el contacto directo con alimentos, sólo usando papel alimenticio de style champêtre, pas de contact direct avec aliments, seulement en utilisant papier alimentaire

	Ø cm	↑ cm	€
11930	17,5	8,5	20,00
11931	11,5	14,0	20,00



**Tischrestebehälter**

table garbage bin  
papelera de sobremesa  
poubelle de table



	Ø cm	↑ cm	ltr.	Farbe / Colour	€
02038	11	14	0,9	White	3,40
02039	11	14	0,9	Black	3,40



**Tischrestebehälter**

table garbage bin  
papelera de sobremesa  
poubelle de table



	Ø cm	↑ cm	ltr.	€
00311	14	15	1,2	4,20



**Tischrestebehälter**

table garbage bin  
papelera de sobremesa  
poubelle de table



**Kunststoff weiß / granit, abnehmbarer Schwingdeckel**  
white plastic, swing cover, cover removable  
plástico blanco/granito, tapa basculante desmontable  
plastique blanc/gris chiné, couvercle basculant démontable

	Ø cm	↑ cm	ltr.	€
00031	12	18	1,4	6,60





# Baskets

PROFI LINE .....	358
GN LINE .....	362
ECONOMIC .....	364
BASIC .....	368
BASKETS   COVERS .....	369
BREAD BASKETS .....	370
SVART .....	374
URBAN .....	378
STAINLESS STEEL BASKETS .....	382
BASKETS   RISERS .....	385
SUPERBOX .....	386

# PROFI LINE



**hellbeige** / light beige  
beis claro / beige clair

**beige** / beige  
beis / beige

**braun** / brown  
marrón / marron

**schwarz** / black  
negro / noir

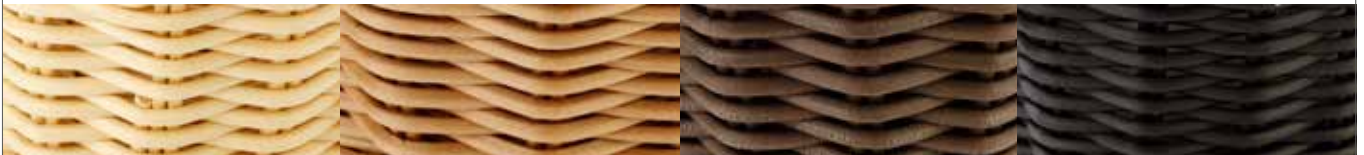

50915

50918

Korb "PROFI LINE"  
basket baker size  
cesta tamaño panaderia  
corbeille dimensions „boul-pâte“



	cm	↑ cm	Farbe / Colour	€
50915	60 x 40	5	hellbeige	40,00
50918	60 x 40	5	schwarz	40,00



50910

50913

Korb "PROFI LINE"  
basket baker size  
cesta tamaño panaderia  
corbeille dimensions „boul-pâte“



	cm	↑ cm	Farbe / Colour	€
50910	60 x 20	5	hellbeige	27,00
50913	60 x 20	5	schwarz	27,00



50908

50710

Korb "PROFI LINE"  
basket baker size  
cesta tamaño panaderia  
corbeille dimensions „boul-pâte“



	cm	↑ cm	Farbe / Colour	€
50905	40 x 30	5	hellbeige	24,00
50908	40 x 30	5	schwarz	24,00

	cm	↑ cm	Farbe / Colour	€
50710	40 x 30	10	hellbeige	26,00
50712	40 x 30	10	schwarz	26,00



**Systemkorb, gestäbt „PROFI LINE“**

basket  
cesta  
corbeille



	cm	↑ cm	Farbe / Colour	€
50305	45 x 40	27 / 16		80,00



**Systemkorb „PROFI LINE“**

basket  
cesta  
corbeille



	cm	↑ cm	Farbe / Colour	€
50400	40 x 50	25 / 14		62,00



**GN 1/1 Korb „PROFI LINE“**

GN 1/1 basket  
GN 1/1 cesta  
GN 1/1 corbeille

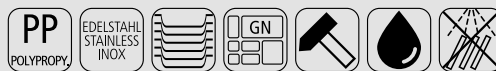

	cm	↑ cm	Farbe / Colour	€
50722	53 x 32,5	10		33,00



**Korb, rund „PROFI LINE“**

basket, round  
cesta redonda  
corbeille ronde



	Ø cm	↑ cm	Farbe / Colour	€
50205	31 / 37	12 / 6		26,00



**Korb, rund „PROFI LINE“**

basket, round  
cesta redonda  
corbeille ronde



	Ø cm	↑ cm	Farbe / Colour	€
50210	37	9		20,60



**Korb, rechteckig „PROFI LINE“**

basket, rectangular  
cesta, rectangular  
corbeille, rectangulaire



	cm	↑ cm	Farbe / Colour	€
50702	26,5 x 19	7		11,80

	cm	↑ cm	Farbe / Colour	€
50707	31 x 21	9		13,50

## PROFI LINE



### Baguette Korb, oval „PROFI LINE“

baguette basket, oval  
cesta de baguette, oval  
corbeille à baguettes, ovale



	cm	↑ cm	Farbe / Colour	€
50805	28 x 16	8		10,80
50806	28 x 16	8		10,80
50808	28 x 16	8		10,80
50807	28 x 16	8		10,80

	cm	↑ cm	Farbe / Colour	€
50823	40 x 16	8		14,20



### Korb, oval „PROFI LINE“

basket, oval  
cesta oval  
corbeille ovale



	cm	↑ cm	Farbe / Colour	€
50800	25 x 19	6,5		9,40
50801	25 x 19	6,5		9,40
50803	25 x 19	6,5		9,40
50802	25 x 19	6,5		9,40

	cm	↑ cm	Farbe / Colour	€
50815	32 x 23	7		12,00
50817	32 x 23	7		12,00



### Korb, rund „PROFI LINE“

basket, round  
cesta redonda  
corbeille ronde



	Ø cm	↑ cm	Farbe / Colour	€
50600	16	8		8,00
50601	16	8		8,00
50603	16	8		8,00
50602	16	8		8,00

	Ø cm	↑ cm	Farbe / Colour	€
50605	20	8		10,80
50606	20	8		10,80
50608	20	8		10,80
50607	20	8		10,80

	Ø cm	↑ cm	Farbe / Colour	€
50612	29	7		13,40



### Korb, rechteckig „PROFI LINE“

basket, rectangular  
cesta rectangular  
corbeille rectangulaire



	cm	↑ cm	Farbe / Colour	€
50631	19 x 13	6		5,60
50630	19 x 13	6		5,60





50624

**Korb, oval „PROFI LINE“**

basket, oval  
cesta, oval  
corbeille, ovale



	cm	↑ cm	Farbe / Colour	€
50624	19 x 12	6		5,60
50625	19 x 12	6		5,60
50627	19 x 12	6		5,60
50626	19 x 12	6		5,60



50620

50621

50622

50623

**Korb, rund „PROFI LINE“**

basket, round  
cesta, redonda  
corbeille, ronde



	Ø cm	↑ cm	Farbe / Colour	€
50620	13	10		5,60
50621	13	10		5,60
50623	13	10		5,60
50622	13	10		5,60



**Auslage Tablett flach „PROFI LINE“**

display tray flat, baker size  
bandeja de presentación, tamaño panadería  
plateau de présentation, dimensions „boul-pâte“



	cm	↑ cm	Farbe / Colour	€
40296	40 x 30	1		18,20
40297	60 x 40	1		32,00



**Eierkorb „PROFI LINE“**

egg basket  
cesta de huevos  
panier à oeufs



**mit Edelstahldraht im Rand, für ca. 20 Eier, hält den Inhalt durch das Stofffutter lange warm**  
with stainless steel wire in the rim, for around 20 eggs, keeps the eggs warm thanks to the fabric lining  
con alambre de acero inoxidable en el borde, para unos 20 huevos, mantiene los huevos calientes gracias al forro de tela  
avec un fil d'acier inox dans la jante, pour env. 20 oeufs, garde les oeufs au chaud grâce à la doublure en tissu

	Ø cm	↑ cm	Farbe / Colour	€
40299	26	17		24,00

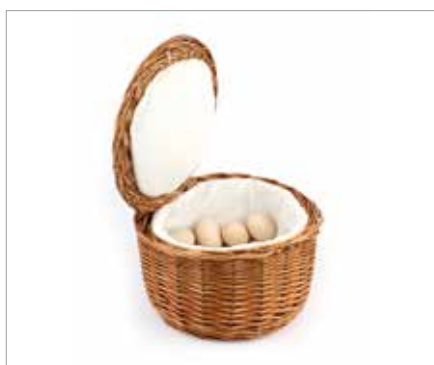

**Eierkorb**

egg basket  
cesta de huevos  
panier à oeufs



**stabile Vollweide, für ca. 20 Eier, hält den Inhalt durch das Stofffutter lange warm**  
stable willow, for around 20 eggs, keeps the eggs warm thanks to the fabric lining  
saule de estable, para unos 20 huevos, mantiene los huevos calientes gracias al forro de tela  
saule stable, pour env. 20 oeufs, garde les oeufs au chaud grâce à la doublure en tissu

	Ø cm	↑ cm	Farbe / Colour	€
30299	26	17		21,00

# GN LINE

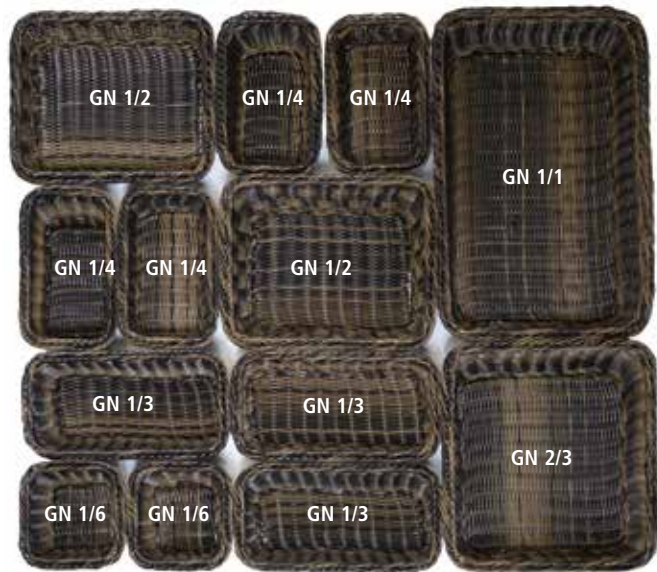

**2 Höhen - 6,5 und 10 cm**  
2 heights - 6,5 and 10 cm



40293  
GN 1/1 - 10 cm



40292  
GN 1/2 - 10 cm

40225  
GN 1/4 - 6,5 cm

## Korb „GN LINE“

GN basket

GN cesta

GN corbeille



**stabile Ausführung mit Edelstahldraht im Rand zur Stabilisierung**

very solid with stainless steel wire frame to stabilize the basket

muy resistente con refuerzo de alambre inox

très résistante avec son fil de renfort inox

	cm	↑ cm	GN	Farbe / Colour	€
40291	53,0 x 32,5	6,5	1/1		26,00
40290	32,5 x 26,5	6,5	1/2		15,80
40223	32,5 x 17,6	6,5	1/3		12,60
40225	26,5 x 16,2	6,5	1/4		9,60
40227	17,6 x 16,2	6,5	1/6		6,50
40229	32,5 x 35,4	6,5	2/3		18,80

	cm	↑ cm	GN	Farbe / Colour	€
40293	53,0 x 32,5	10,0	1/1		31,40
40292	32,5 x 26,5	10,0	1/2		18,80
40243	32,5 x 17,6	10,0	1/3		14,80
40245	26,5 x 16,2	10,0	1/4		11,40
40247	17,6 x 16,2	10,0	1/6		9,60
40249	32,5 x 35,4	10,0	2/3		23,00



GN 1/1

## GN 1/1 Besteckbehälter

GN 1/1 dispenser GN

GN 1/1 dispensador de cubiertos

GN 1/1 bac à couverts



**4 Mulden, Kunststoff-Geflecht, Drahtgestell, braun-schwarz**

4 compartments, with reinforced chromed wire structure, brown-black

4 compartimentos, de plástico, con bastidor cromado reforzado, marrón oscuro

4 compartiments, en plastique, cadre acier chromé renforcé, couleur marron foncé

	cm	↑ cm	GN	Farbe / Colour	€
11966	53 x 32,5	9	1/1		41,00

## GN LINE



2 Höhen - 6,5 und 10 cm  
2 heights - 6,5 and 10 cm



40220 GN 1/1



40222 GN 1/2



40228 GN 1/6



40264 GN 1/4

40272 GN 1/2

## Korb „GN LINE“

GN basket  
GN cesta  
GN corbeille



stabile Ausführung mit Edelstahldraht im Rand zur Stabilisierung

very solid with stainless steel wire frame to stabilize the basket

muy resistente con refuerzo de alambre inox

très résistante avec son fil de renfort inox

	cm	↑ cm	GN	Farbe / Colour	€
40220	53,0 x 32,5	6,5	1/1		23,00
40222	32,5 x 26,5	6,5	1/2		13,90
40224	32,5 x 17,6	6,5	1/3		11,80
40226	26,5 x 16,2	6,5	1/4		8,80
40228	17,6 x 16,2	6,5	1/6		6,20
40230	32,5 x 35,4	6,5	2/3		18,20
	cm	↑ cm	GN	Farbe / Colour	€
40240	53,0 x 32,5	10	1/1		30,00
40242	32,5 x 26,5	10	1/2		18,40
40244	32,5 x 17,6	10	1/3		13,90
40246	26,5 x 16,2	10	1/4		10,00
	cm	↑ cm	GN	Farbe / Colour	€
40260	53,0 x 32,5	6,5	1/1		23,00
40262	32,5 x 26,5	6,5	1/2		13,90
40263	32,5 x 17,6	6,5	1/3		11,40
40264	26,5 x 16,2	6,5	1/4		8,80
	cm	↑ cm	GN	Farbe / Colour	€
40270	53,0 x 32,5	10	1/1		30,00
40272	32,5 x 26,5	10	1/2		18,40
40274	32,5 x 17,6	10	1/3		13,90
40276	26,5 x 16,2	10	1/4		9,90

# ECONOMIC



Tisch- und Buffetkorb „ECONOMIC“  
buffet basket  
cesta de buffet  
corbeille de buffet



	Ø cm	↑ cm	Farbe / Colour	€
40132	19,0	9,5		5,40
40135	25,5	8,5		7,40
40144	39,0	10,0		19,00
40191	19,0	9,5		5,40
40192	25,5	8,5		7,40

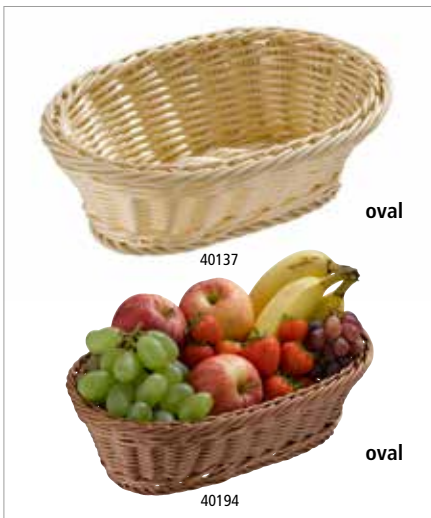

Tisch- und Buffetkorb „ECONOMIC“  
buffet basket  
cesta de buffet  
corbeille de buffet



	cm	↑ cm	Farbe / Colour	€
40137	23,0 x 17	8,0		5,90
40139	28,5 x 17	8,5		7,60
40193	23,0 x 17	8,0		5,90
40194	28,5 x 17	8,5		7,60



stapelbar  
stackable



Tisch- und Buffetkorb „ECONOMIC“  
buffet basket  
cesta de buffet  
corbeille de buffet



	cm	↑ cm	Farbe / Colour	€
40140	23,0 x 17	8		5,90
40159	31,5 x 22	8,5		8,80
40195	23,0 x 17	8		5,90
40196	31,5 x 22	8,5		8,80



GN Buffetkorb „ECONOMIC“  
GN basket  
GN cesta  
GN corbeille



	cm	↑ cm	GN	Farbe / Colour	€
40148	53 x 32,5	8	1/1		33,00



GN Buffetkorb „ECONOMIC“  
GN basket  
GN cesta  
GN corbeille



	cm	↑ cm	GN	Farbe / Colour	€
40152	32,5 x 26,5	8	1/2		13,20

**Buffetkorb „ECONOMIC“**

buffet basket  
cesta de buffet  
corbeille de buffet



**stabile Ausführung mit Edelstahldraht im Rand zur Stabilisierung**

very solid with stainless steel wire frame to stabilize the basket

muy resistente con refuerzo de alambre inox

très résistante avec son fil de renfort inox

	cm	↑ cm	€
40153	45 x 42	17 / 24	34,90



40149

**Buffetkorb, rund „ECONOMIC“**

buffet basket, round  
cesta de buffet, redonda  
corbeille de buffet ronde



**stabile Ausführung mit Edelstahldraht im Rand zur Stabilisierung**

very solid with stainless steel wire frame to stabilize the basket

muy resistente con refuerzo de alambre inox

très résistante avec son fil de renfort inox

	Ø cm	↑ cm	Farbe / Colour	€
40149	40	12,5		25,20
40295	40	12,5		23,00



18389

40295

**Rolltophaube mit verchromtem Kugelgriff / rolltop cover with chrome plated handle / campana abatible con pomo cromado / cloche basculante avec bouton chromé**

	Ø cm	↑ cm	€
18388	38	20	24,00

**Rolltophaube mit vergoldetem Kugelgriff / rolltop cover with gold plated handle / campana abatible con pomo dorado / cloche basculante avec bouton doré**

	Ø cm	↑ cm	€
18387	38	20	24,00

**Rolltophaube mit verchromtem Designergriff / rolltop cover with chrome plated designer handle / campana abatible con pomo de diseño cromado / cloche basculante avec bouton design chromé**

	Ø cm	↑ cm	€
18389	38	20	23,00



11010

40150

**Buffetkorb „ECONOMIC“**

buffet basket  
cesta de buffet  
corbeille buffet



**stabile Ausführung, Edelstahl Fixierungsrahmen, zur Rutschsicherung, ohne Haube**

stainless steel fix the cover, without cover

con marco cromado patentado para fijar y encajar la campana (se entrega sin la campana)

cadre fil acier inoxydable pour fixer la cloche (livré sans la cloche)

	cm	↑ cm	Farbe / Colour	€
40150	56,5 x 36	10		40,00
40294	56,5 x 36	10		33,00



11018

40294

**GN 1/1 Rolltop-Haube / GN 1/1 rolltop cover / GN 1/1 campana abatible / GN 1/1 cloche basculante**

	cm	↑ cm	GN	€	
11008	53 x 32,5	19	1/1	vergoldeter Griff / gold plated handle pomo dorado / bouton doré	62,00
11010	53 x 32,5	19	1/1	verchromter Griff / chrome plated handle pomo cromado / bouton chromé	62,00
11018	53 x 32,5	17	1/1	mit verchromtem Designergriff with chrome plated designer handle	64,00

## ECONOMIC



### Buffetgestell „DOPPELDECKER“ für GN

buffet frame for GN  
estructura para buffet para GN  
support buffet pour GN



2-teilig, einfach zusammensetzbar, Etagen-Abstand 26 cm, platzsparend, stabile Ausführung

2 pcs., easy to assemble, distance between the tiers 26 cm, space-saving, robust

2 pzas, fácil de montar, distancia entre pisos 26 cm, robusto

2 pcs, assemblage facile, distance entre niveaux 26 cm, robuste

	cm	↑ cm	fits to GN	€
11555	50 x 34	37,5	1/1	90,00



### GN Kuppelhaube

GN cover  
GN cúpula  
GN cloche bombée



glasklarer Kunststoff, Griff aus Zinkdruckguss

crystal clear plastic, die-cast zinc knob

plástico transparente, asa de zinc fundido a presión

plastique transparente, poignée en zinc moulé sous pression

	cm	↑ cm	GN		€
11026	54 x 33	20	1/1	geschlossen / totally closed cerrada / totalmente fermée	52,00
11027	54 x 33	20	1/1	mit Front-Ausschnitt / one long side cut out gran apertura frontal / grande ouverture frontale	54,00
11028	54 x 33	20	1/1	mit seitlichem Ausschnitt / one small side cut out / pequeña apertura lateral / petite ouverture latérale	54,00



### GN Kuppelhaube

GN cover  
GN cúpula  
GN cloche bombée



glasklarer Kunststoff, Griff aus Zinkdruckguss

crystal clear plastic, die-cast zinc knob

plástico transparente, asa de zinc fundido a presión

plastique transparente, poignée en zinc moulé sous pression

	cm	↑ cm	GN		€
11070	54 x 33	20	1/1	geschlossen / totally closed cerrada / totalmente fermée	52,00
11071	54 x 33	20	1/1	mit Front-Ausschnitt / one long side cut out gran apertura frontal / grande ouverture frontale	54,00
11072	54 x 33	20	1/1	mit seitlichem Ausschnitt / one small side cut out / pequeña apertura lateral / petite ouverture latérale	54,00



### Baguettekorb „ECONOMIC“

baguette basket  
cesta para baguette  
corbeille pour baguettes



stabile Ausführung mit Edelstahl draht im Rand zur Stabilisierung

very solid with stainless steel wire frame to stabilize the basket

muy resistente con refuerzo de alambre inox

très résistante avec son fil de renfort inox

	Ø cm	↑ cm	Farbe / Colour	€
40198	35	24 / 42	Yellow	57,00



**Besteckkorb „ECONOMIC“**

cutlery dispenser  
dispensador de cubiertos  
corbeille à couverts



4 Fächer (3 kleine und 1 großes) / 4 compartments (3 small and 1 large) /  
4 compartimentos (3 pequeños y 1 grande) / 4 compartiments (3 petits et 1 grand)

	cm	↑ cm	Farbe / Colour	€
40179	26 x 18	15		17,60
40182	26 x 18	15		17,60



**Besteckkorb „ECONOMIC“**

cutlery dispenser  
dispensador de cubiertos  
corbeille à couverts



	Ø cm	↑ cm	Farbe / Colour	€
40130	12	15		4,80
40007	12	15		4,80
40012	12	15		4,80
40013	12	15		4,80



**Besteckkorb „ECONOMIC“**

cutlery dispenser  
dispensador de cubiertos  
corbeille à couverts



	cm	↑ cm	Farbe / Colour	€
40131	27 x 10	4,5		4,80
40009	27 x 10	4,5		4,80
40010	27 x 10	4,5		4,80
40011	27 x 10	4,5		4,80

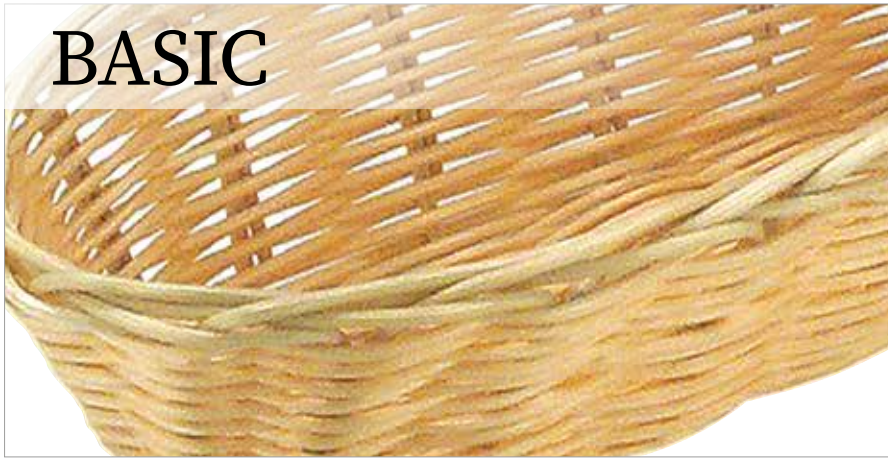

- in Handarbeit geflochten
- einfache und leichte Ausführung

- wickerwork
- simple and light version

- ligera
- tressada a mano

- tressé à main
- version légère



oval

**Brot- und Obstkorb „BASIC“**  
 basket for bread or fruits  
 cesta para pan o fruta  
 corbeille à pain ou à fruits



	cm	↑ cm	€
30279	18 x 12	7	3,20
30280	23 x 15	6	3,40



oval

**Brot- und Obstkorb „BASIC“**  
 basket for bread or fruits  
 cesta para pan o fruta  
 corbeille à pain ou à fruits



	cm	↑ cm	€
30282	21 x 10	6	3,00



rund

**Brot- und Obstkorb „BASIC“**  
 basket for bread or fruits  
 cesta para pan o fruta  
 corbeille à pain ou à fruits



	Ø cm	↑ cm	€
30281	20	7	3,40
30285	25	7	4,70



rechteckig

**Tisch- und Buffetkorb „BASIC“**  
 buffet basket  
 cesta de buffet  
 corbeille de buffet



	cm	↑ cm	€
30286	30 x 22	7	4,60
30283	22 x 15	6	3,70





**Brot- und Obstkorb „WICKER LOOK“**

basket for bread or fruits  
cesta para pan o fruta  
corbeille à pain ou à fruits



	cm	↑ cm	Farbe / Colour	€
40214	Ø 20	6,5	■	3,20
40216	23 x 17	6,5	■	3,50
	cm	↑ cm	Farbe / Colour	€
40212	39,5 x 29,5	10	■	10,00



**GN 1/1 Korb „SUPERSTRONG“**

GN 1/1 basket  
GN 1/1 cesta  
GN 1/1 corbeille



	cm	↑ cm	GN	Farbe / Colour	€
50644	53 x 32,5	10,0	1/1	■ ■	34,20

**GN Kuppelhaube / GN cover / GN cúpula / GN cloche bombée**

	cm	↑ cm	GN	€
11027	54 x 33	20	1/1	54,00



passend zu Regalwagen 71441, S. 365  
suitable for trolley 71441, S. 365



**GN Kuppelhaube**

GN cover  
GN cúpula  
GN cloche bombée

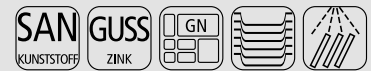

glasklarer Kunststoff, Griff aus Zinkdruckguss

crystal clear plastic, die-cast zinc knob

plástico transparente, asa de zinc fundido a presión

plastique transparente, poignée en zinc moulé sous pression

	cm	↑ cm	GN	€	
11070	54 x 33	20	1/1	geschlossen / totally closed cerrada / totalmente fermée	52,00
11071	54 x 33	20	1/1	mit Front-Ausschnitt / one long side cut out gran apertura frontal / grande ouverture frontale	54,00
11072	54 x 33	20	1/1	mit seitlichem Ausschnitt / one small side cut out / pequeña apertura lateral / petite ouverture latérale	54,00



**GN Abdeckhaube**

GN cover  
GN cubierta  
GN cloche



passend für GN 1/1 Körbe, glasklarer Kunststoff, nahezu bruchfest

suitable for GN 1/1 baskets, clear plastic, nearly unbreakable

apto para cestas GN 1/1, plástico transparente, muy resistente a la rotura

pour bacs et corbeilles GN 1/1, plastique transparent, très résistant à la casse

	cm	↑ cm	mm	GN	€
11042	53,0 x 32,5	9,5	3	1/1	32,00

# BREAD BASKETS



Umgekrempelt kann die Höhe individuell gestaltet werden!  
Adjustable height by turning the edge upside down!  
Altura ajustable girando el borde al revés!  
Hauteur ajustable en tournant le bord à l'envers!



**Brottasche**  
bread basket  
panera  
corbeille



eckig, 70% Naturfaser und 30% Kunstharz  
angular, 70% natural fibre and 30% synthetic resin  
ángulo, 70% fibra natural y 30% resina sintética  
carré, 70% de fibres naturelles et 30% de résine synthétique

	cm	↑ cm	Farbe / Colour	€
30355	12 x 11,5	11,5		6,80
30356	12 x 11,5	11,5		6,80

rund, 70% Naturfaser und 30% Kunstharz  
round, 70% natural fibre and 30% synthetic resin  
redondo, 70% fibra natural y 30% resina sintética  
ronde, 70% de fibres naturelles et 30% de résine synthétique

	Ø cm	↑ cm	Farbe / Colour	€
30440	17	11		7,20
30450	20	13		8,20
30442	24	24		12,50
30443	30	22		14,80
30441	17	11		7,20
30451	20	13		8,20
30445	24	24		12,50
30446	30	22		14,80



**Brottasche**  
bread basket  
panera  
corbeille



rund, schmutzabweisende Kunstfaser, 30°C waschbar, wendbar  
round, dirt-repellent synthetic fibre, washable 30°C, reversible  
redondo, fibra sintética repelente a la suciedad, lavable a 30°C, reversible  
ronde, fibre synthétique anti-salissante, lavable à 30°C, réversible

	Ø cm	↑ cm	Farbe / Colour	€
30345	17	11,5	■ ■	8,40
30346	20	13,5	■ ■	10,40



**Brottasche**  
bread basket  
panera  
corbeille



rechteckig, schmutzabweisende Kunstfaser, 30°C waschbar, wendbar  
rectangular, dirt-repellent synthetic fibre, washable 30°C, reversible  
rectangular, fibra sintética repelente a la suciedad, lavable a 30°C, reversible  
rectangulaire, fibre synthétique anti-salissante, lavable à 30°C, réversible

	cm	↑ cm	Farbe / Colour	€
30347	19 x 11	10,5	■ ■	9,30
30348	24 x 16	10,5	■ ■	11,50



Präsentationsmöglichkeit  
presentation example



**Brottasche**  
bread basket  
panera  
corbeille à pain en toile



Baumwolle, umgekrempelt kann die Höhe individuell gestaltet werden, maschinenwaschbar bis 30°C  
cotton, adjustable height by turning the edge upside down, machine-washable 30°C  
walgodón, altura ajustable girando el borde al revés, lavable a máquina 30°C  
coton, hauteur ajustable en tournant le bord à l'envers, lavable en machine maxi 30°C

	Ø cm	↑ cm	Farbe / Colour	€
30340	17	11	■ ■	7,00
30350	20	12	■ ■	7,70
30341	17	11	■ ■	7,00
30351	20	12	■ ■	7,70

	cm	↑ cm	Farbe / Colour	€
30360	20 x 15	10	■ ■	7,30
30370	25 x 18	12	■ ■	8,30
30361	20 x 15	10	■ ■	7,30
30371	25 x 18	12	■ ■	8,30

## BREAD BASKETS



30380

30390

### Brottasche mit Wärmekissen

bread basket with stones pillow

panera con cojin

corbeille à pain en toile avec coussin chauffant



**Baumwolle, Keramik-Kugeln, maschinenwaschbar bis 30°C, mit Zugverschluss, Wärmekissen kann einfach in der Mikrowelle erhitzt werden (90 Sekunden / 500 Watt)**

cotton, ceramic balls, machine washable up to 30°C, with drawstring closure, heat pad can easily be heated in the microwave (90 seconds / 500 watts)

algodón, bolas de cerámica, lavable a máquina hasta 30°C, con cierre de cordón, la almohadilla térmica se puede calentar fácilmente en el microondas (90 segundos / 500 vatios)

coton, billes en céramique, lavable en machine jusqu'à 30°C, avec fermeture à tirette, le coussin chauffant peut être facilement chauffé au micro-ondes (90 secondes / 500 watts)

	Ø cm	↑ cm	Farbe / Colour	€
30380	19	23		21,00
30390	19	23		21,00

**Wärmekissen / stones pillow / cojín de piedrecillas a calentar / coussin de petites pierres, à chauffer**

	Ø cm	↑ cm	€
30385	19	1,5	5,90



30395

30396

### Häkelkorb

crochet rope basket

cesta de ganchillo

panier au crochet

**umgekrepelt kann die Höhe individuell eingestellt werden**

adjustable height by turning the edge upside down

altura ajustable girando el borde al revés

hauteur ajustable en tournant le bord à l'envers



	cm	↑ cm	€
30395	20 x 13,5	10	8,50
30396	24 x 17,5	12	9,40



**Präsentationsmöglichkeit**  
presentation example

NEW



**Brot- und Obstkorb**  
basket for bread or fruits  
cesta para pan o fruta  
corbeille à pain ou à fruits



inklusive Tasche aus Baumwolle, beige grau, maschinenwaschbar bis 30 Grad  
incl. bag made of cotton, beige, grey, machine washable up to 30°C  
bolsa incluida, de algodón, beige, gris, lavable a máquina hasta 30°C  
sac inclus en coton, beige, gris, lavable en machine jusqu'à 30°C

	Ø cm	↑ cm	€
30209	27,5	18,5	29,00



stapelbar  
stackable

rutschfest inklusive Klipp  
non-slip, includes clip



40690 0,7 ltr.



40691 0,7 ltr.



40692 0,7 ltr.



40693 1,4 ltr.



40694 1,4 ltr.



40695 1,4 ltr.

**Schale**  
bowl  
cuenco  
bol



gehämmerte Oberfläche  
hammered surface  
superficie martillada  
surface martelée

	Ø cm	↑ cm	ltr.	Farbe / Colour	€
40690	15,5 x 12,0	5,5	0,7	gold look	14,00
40691	15,5 x 12,0	5,5	0,7	copper look	14,00
40692	15,5 x 12,0	5,5	0,7	gunmetal look	14,00
40693	23,0 x 15,5	6,0	1,4	gold look	21,00
40694	23,0 x 15,5	6,0	1,4	copper look	21,00
40695	23,0 x 15,5	6,0	1,4	gunmetal look	21,00



Präsentationsmöglichkeit  
presentation example



NEW

SVART



NEW



30425



30426

Korb „SVART“

basket  
cesta  
corbeille



Farbe: whisper white / colour: whisper white / color: blanco crema / couleur: blanc-crème

	Ø cm	↑ cm	Farbe / Colour	€
30425	17,5	8		13,00
30426	20	8		15,00



NEW



30427



30428

Korb „SVART“

basket  
cesta  
corbeille



Farbe: whisper white / colour: whisper white / color: blanco crema / couleur: blanc-crème

	cm	↑ cm	Farbe / Colour	€
30427	20 x 15	8		13,00
30428	24 x 19	8		17,80



NEW



Korb „SVART“

basket  
cesta  
corbeille



Farbe: whisper white / colour: whisper white / color: blanco crema / couleur: blanc-crème

	cm	↑ cm	Farbe / Colour	€
30429	29,5 x 25,5	13,5		26,00

**NEW** SVART



**Korb „SVART“**

basket  
cesta  
corbeille



Farbe: dream blue / colour: dream blue / color: azul / couleur: bleu

	Ø cm	↑ cm	Farbe / Colour	€
30452	17,5	8		13,00
30453	20	8		15,00



**Korb „SVART“**

basket  
cesta  
corbeille



Farbe: dream blue / colour: dream blue / color: azul / couleur: bleu

	cm	↑ cm	Farbe / Colour	€
30454	20 x 15	8		13,00
30455	24 x 19	8		17,80

**NEW** SVART

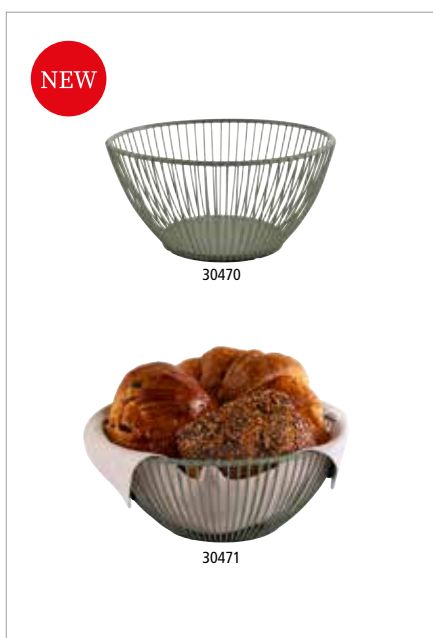

**Korb „SVART“**

basket  
cesta  
corbeille



Farbe: **smoke green** / colour: smoke green / color: verde oscuro / couleur: vert foncé

	Ø cm	↑ cm	Farbe / Colour	€
30470	17,5	8		13,00
30471	20	8		15,00



**Korb „SVART“**

basket  
cesta  
corbeille



Farbe: **smoke green** / colour: smoke green / color: verde oscuro / couleur: vert foncé

	cm	↑ cm	Farbe / Colour	€
30472	20 x 15	8		13,00
30473	24 x 19	8		17,80



# SVART



### Korb „SVART“

basket  
cesta  
corbeille



	cm	↑ cm	Farbe / Colour	€
30424	29,5 x 25,5	13,5	■	26,00



### Korb „SVART“

basket  
cesta  
corbeille



	cm	↑ cm	Farbe / Colour	€
30422	20 x 15	8	■	13,00
30423	24 x 19	8	■	17,80



### Korb „SVART“

basket  
cesta  
corbeille



	Ø cm	↑ cm	Farbe / Colour	€
30420	17,5	8	■	13,00
30421	20,0	8	■	15,00



# URBAN

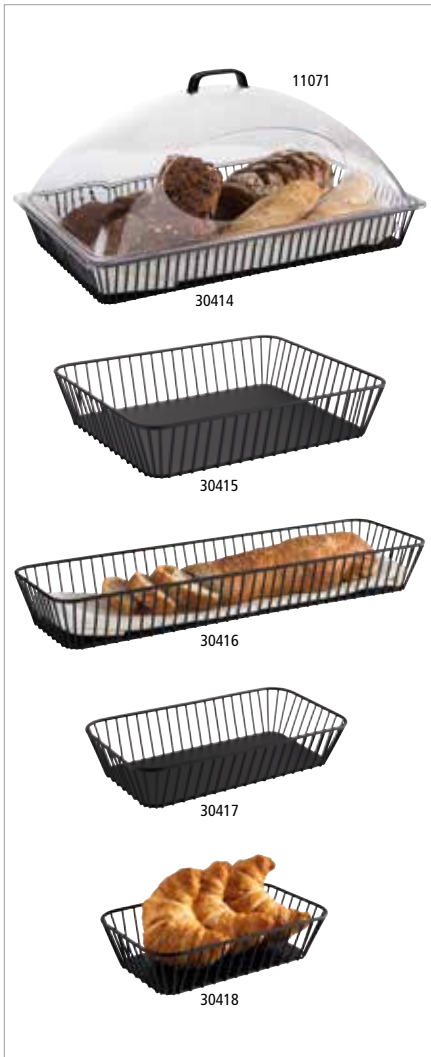

## GN Korb „URBAN“

GN basket  
GN cesta  
GN corbeille



	cm	↑ cm	GN	Farbe / Colour	€
30414	53,0 x 32,5	7,5	1/1	■	35,00
30415	32,5 x 26,5	7,5	1/2	■	26,00
30416	53,0 x 16,2	7,5	2/4	■	26,00
30417 <small>NEW</small>	32,5 x 17,6	7,5	1/3	■	19,00
30418 <small>NEW</small>	26,5 x 16,2	7,5	1/4	■	16,00



## Korb „URBAN“

basket  
cesta  
corbeille



	Ø cm	↑ cm	Farbe / Colour	€
30410	17	7,0	■	14,40
30411	20	8,5	■	18,00



Korb „URBAN“  
basket  
cesta  
corbeille

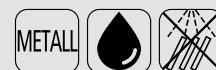

	cm	↑ cm	Farbe / Colour	€
30337	29 x 16	7	■	19,00



Korb „URBAN“  
basket  
cesta  
corbeille



	cm	↑ cm	Farbe / Colour	€
30412	21 x 10	7	■	12,80
30413	30 x 14	12	■	21,00



GN Abdeckhaube  
GN cover  
GN cubierta  
GN cloche



	cm	↑ cm	* mm	GN	€
11041	32,5 x 26,5	9,5	3	1/2	23,00
11042	53,0 x 32,5	9,5	3	1/1	32,00
11043	32,5 x 17,6	10,5	3	1/3	17,00
11044	53,0 x 16,2	10,5	3	2/4	23,00



GN Kuppelhaube  
GN cover  
GN cúpula  
GN cloche bombée



glasklarer Kunststoff, Griff aus Zinkdruckguss

crystal clear plastic, die-cast zinc knob

plástico transparente, asa de zinc fundido a presión

plastique transparente, poignée en zinc moulé sous pression

	cm	↑ cm	GN		€
11070	54 x 33	20	1/1	geschlossen / totally closed cerrada / totalmente fermée	52,00
11071	54 x 33	20	1/1	mit Front-Ausschnitt / one long side cut out gran apertura frontal	54,00
11072	54 x 33	20	1/1	grande ouverture frontale mit seitlichem Ausschnitt one small side cut out pequeña apertura lateral petite ouverture latérale	54,00
11073	33 x 28	17	1/2	geschlossen / totally closed cerrada / totalmente fermée	29,00
11074	33 x 28	17	1/2	mit Front-Ausschnitt / one long side cut out gran apertura frontal grande ouverture frontale	32,00





NEW

# URBAN



## GN Korb „URBAN“

GN basket  
GN cesta  
GN corbeille



Farbe: whisper white / colour: whisper white / color: blanco crema / couleur: blanc-crème

	cm	↑ cm	GN	Farbe / Colour	€
30435	53 x 32,5	7,5	1/1		35,00
30436	32,5 x 26,5	7,5	1/2		26,00
30439	53 x 16,2	7,5	2/4		26,00
30437	32,5 x 17,6	7,5	1/3		19,00
30438	26,5 x 16,2	7,5	1/4		16,00



## Korb „URBAN“

basket  
cesta  
corbeille



Farbe: whisper white / colour: whisper white / color: blanco crema / couleur: blanc-crème

	Ø cm	↑ cm	Farbe / Colour	€
30430	17	7		14,40
30431	20	8,5		18,00



**Besteckbehälter / Korb**  
 cutlery bin / basket  
 porta cubiertos / cesta  
 range-couverts / corbeille  
**matt poliert, Boden: 29 x 8,5 cm**  
 matt polished, base: 29 x 8,5 cm  
 pulido mate, base: 29 x 8,5 cm  
 poli mat, fond: 29 x 8,5 cm



	cm	↑ cm	ltr.	Farbe / Colour	€
11752	29,5 x 12	10	2		11,50



Präsentationsmöglichkeit  
 presentation example



**Besteckbehälter / Korb**  
 cutlery bin / basket  
 porta cubiertos / cesta  
 range-couverts / corbeille  
**Boden: 29 x 8,5 cm**  
 base: 29 x 8,5 cm  
 base: 29 x 8,5 cm  
 fond: 29 x 8,5 cm



	cm	↑ cm	ltr.	Farbe / Colour	€
11753	29,5 x 12	10	2		13,00



Präsentationsmöglichkeit  
 presentation example



**Besteckbehälter / Korb**  
 cutlery bin / basket  
 porta cubiertos / cesta  
 range-couverts / corbeille  
**Boden: 29 x 8,5 cm**  
 base: 29 x 8,5 cm  
 base: 29 x 8,5 cm  
 fond: 29 x 8,5 cm



	cm	↑ cm	ltr.	Farbe / Colour	€
11754	29,5 x 12	10	2		13,00



Präsentationsmöglichkeit  
 presentation example

# STAINLESS STEEL BASKETS



**Obstkorb**  
 basket for fruits  
 cesta para fruta  
 corbeille à fruits  
**hochglanzpoliert**  
 mirror polished finish  
 acabado pulido brillante  
 brillant



	∅ cm	↑ cm	€
30270	21,5	20,5	37,40



**Brot- und Obstkorb**  
 basket for bread or fruits  
 cesta para pan o fruta  
 corbeille à pain ou à fruits  
**hochglanzpoliert, rund**  
 mirror polished finish, round  
 acabado pulido brillante, redondo  
 brillant, rond



	∅ cm	↑ cm	€
30200	17,5	7,0	12,60
30220	20,5	8,5	15,40
30230	25,5	9,5	17,20

oval / oval / oval / oval

	cm	↑ cm	€
30210	20 x 15	7,0	12,60
30240	24 x 19	8,5	15,40
30250	28 x 21	9,5	17,20

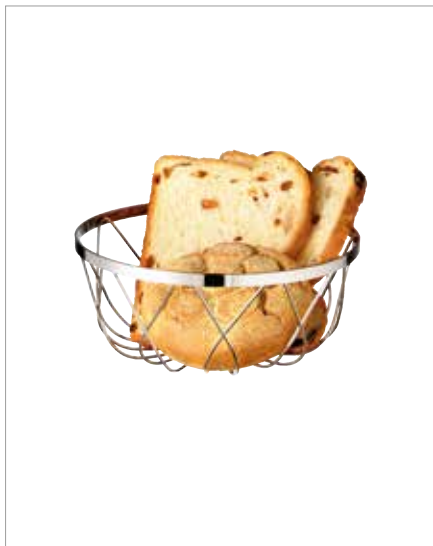

**Brot- und Obstkorb**  
basket for bread or fruits  
cesta para pan o fruta  
corbeille à pain ou fruits



	Ø cm	↑ cm	€
30310	18	7,5	6,20



30276

**Brot- und Obstschale**  
bowl for bread or fruits  
bol para pan o fruta  
bol à pain ou à fruits



hochglanzpoliert, Hammerschlag Optik  
mirror polished finish, hammered look  
acabado pulido efecto espejo, aspecto repujado  
brillant, aspect martelé

	Ø cm	↑ cm	€
30276	16	5,0	3,60
30277	20	5,5	6,00



30277

**Schale**  
bowl  
cuenco  
bol



gehämmerte Oberfläche  
hammered surface  
superficie martillada  
surface martelée

	cm	↑ cm	litr.	€
40189	20 x 13,5	5,5	0,30	8,50
40190	24 x 16,5	7,0	0,45	10,60

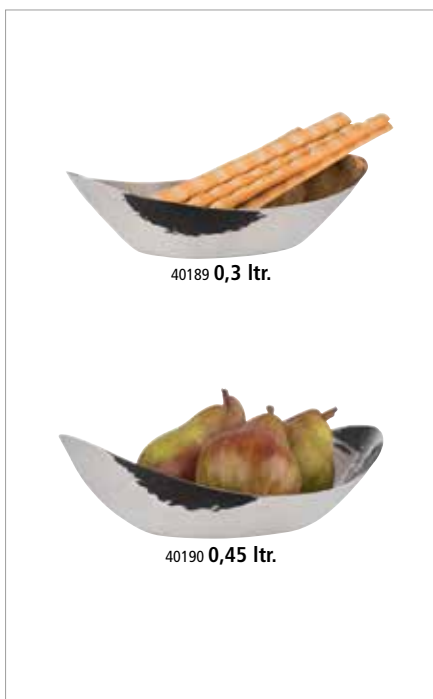

40189 0,3 ltr.



40190 0,45 ltr.



# BASKETS



## Brot- und Obstkorb

basket for bread or fruits  
cesta para pan o fruta  
corbeille à pain ou à fruits



inklusive Tasche aus Baumwolle, beige grau, maschinenwaschbar bis 30 Grad

incl. bag made of cotton, beige, grey, machine washable up to 30°C

bolsa incluida, de algodón, beige, gris, lavable a máquina hasta 30°C

sac inclus en coton, beige, gris, lavable en machine jusqu'à 30°C

	Ø cm	↑ cm	€
30209	27,5	18,5	29,00



stapelbar  
stackable

rutschfest inklusive Klipp  
non-slip, includes clip



30208

## Brot- und Obstkorb

basket for bread or fruits  
cesta para pan o fruta  
corbeille à pain ou fruits



	Ø cm	↑ cm	Farbe / Colour	€
30207	21	16,5	 copper-look handle	13,20
30208	30	19,0	 copper-look handle	16,40



## Brot- und Obstkorb „WIRE“

wire basket  
cesta para pan o fruta  
corbeille pour pain ou fruits



	Ø cm	↑ cm	Farbe / Colour	€
30206	31	14	 metal black	15,80



# BASKETS / RISERS



## Korb / Ständer „APS PLUS“

basket / riser  
cesta / soporte  
corbeille / support



	Ø cm	↑ cm	Farbe / Colour	€
15320	10,5 / 8	8	polished chrome	16,40
15324	10,5 / 8	8	brushed gold	16,40
15322	10,5 / 8	8	brushed copper	15,00



## Korb / Ständer „APS PLUS“

basket / riser  
cesta / soporte  
corbeille / support



	Ø cm	↑ cm	Farbe / Colour	€
15336 <small>NEW</small>	15	10,5	black	23,00
15337 <small>NEW</small>	21	20,0	black	35,00
15331	15	10,5	polished chrome	26,80
15332	21	20,0	polished chrome	43,70
15334	15	10,5	brushed gold	26,80
15335	21	20,0	brushed gold	43,70



Präsentationsmöglichkeit  
presentation example



## Korb / Ständer „APS PLUS“

basket / riser  
cesta / soporte  
corbeille / support



	Ø cm	↑ cm	Farbe / Colour	€
15326	21 / 15	21	black	26,80



# SUPERBOX

00973  
Schieferplatte  
GN 2/4

11620  
Box GN 1/1

11621  
Box GN 1/2

Die stapelbaren Wendeboxen lassen sich rutschfest stapeln und mit flachen GN Platten verbinden und einzeln nutzen. Individuell können Buffet-landschaften gebaut werden.

The stackable and non-slip reversible boxes can be connected to flat GN trays and can also be used individually. Different and individual buffet sceneries can be built up.

Las cajas girables y apilables son antideslizantes y se pueden conectar con bandejas planas GN o utilizar individualmente. Se pueden construir diferentes paisajes de buffet muy individuales.

Les boîtes de tournage empilables sont antiglissantes et peuvent être connectées avec des plateaux plats GN ou utilisées individuellement. Des paysages de buffet très personnalisés peuvent être construits.



NEW

2 tlg.  
2 pcs.

11719

## Beschriftungsschilder, 2er Set inscription labels, 2 pcs. étiquettes d'inscription, set de 2 etiquetas de inscripción, set de 2



	cm	↑ cm	Farbe / Colour	€
11719	8 x 1,5	5,5	■	8,00



## Kreide-Marker, Stärke 2 mm, 2er Set chalk marker, 2 pcs. rotulador de tiza, set de 2 marqueur a la craie liquide, set de 2



	Ø cm	↑ cm	Farbe / Colour	pcs.	€ / set
71490	1	13	■	2	6,20



11626

11721

## GN 1/1 „SUPERBOX“



Akazienholz / acacia wood / madera de acacia / bois d'acacia

	cm	↑ cm	GN	Farbe / Colour	€
11620	55,5 x 35,0	10,5	1/1	■	44,00
11626	55,5 x 35,0	10,5	1/1	■	44,00
11721	55,5 x 35,0	20,0	1/1	■	67,00
11723	55,5 x 35,0	20,0	1/1	■	67,00



GN 2/4 „SUPERBOX“

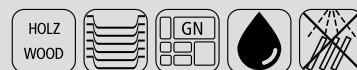

Akazienholz / acacia wood / mader de acacia / bois d'acacia

	cm	↑ cm	Farbe / Colour	€
11623	55,5 x 18,5	10,5		35,00
11629	55,5 x 18,5	10,5		35,00



GN 1/2 „SUPERBOX“

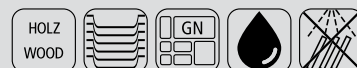

Akazienholz / acacia wood / mader de acacia / bois d'acacia

	cm	↑ cm	GN	Farbe / Colour	€
11621	35,0 x 29,0	10,5	1/2		28,00
11627	35,0 x 29,0	10,5	1/2		28,00
11722	35,0 x 29,0	20,0	1/2		42,50
11724	35,0 x 29,0	20,0	1/2		42,50



GN 1/4 „SUPERBOX“



Akazienholz / acacia wood / mader de acacia / bois d'acacia

	cm	↑ cm	Farbe / Colour	€
11622	29 x 18,5	10,5		22,00
11628	29 x 18,5	10,5		22,00



Buffetgestell

buffet stand  
soporte para buffet  
présentoir buffet



Metall, schwarz, passend für GN Boxen, mit Antrutschfüßchen

metal, black, suitable for GN boxes, with non-slip feet

metal, negro, para cajas GN, con pies antideslizantes

métal, noir, pour boîtes GN, avec pieds antidérapantsw

	cm	↑ cm	suitable for	Farbe / Colour	€
30329 <small>new</small>	29 x 32,5	48	GN 1/2 boxes		42,00
30331	49 x 38,5	48	GN 1/1, GN 1/2 boxes		50,00



Präsentationsmöglichkeit  
presentation example





# Chafing Dish, GN Container & Transport

PREMIUM .....	390
GLOBE .....	392
EASY INDUCTION .....	396
CHAFING DISHES .....	398
ELECTRIC CHAFING DISHES .....	400
SOUP WARMERS .....	401
INDUCTION STATION .....	403
INDUCTION PLATES   HEATING UNITS .....	404
CHAFING DISHES   ACCESSORIES .....	405
THERMAL BRIDGE   WARMERS .....	406
5 STARS .....	408
COFFEE AND TEADISPENSER .....	412
GN-CONTAINERS .....	414
SERVING TROLLEYS .....	426
CUTLERY BOXES .....	428
CONTAINERS   EGG BOXES .....	432
BUCKETS   FUNNELS .....	433

# PREMIUM



### langlebige Deckelbremse

Abnehmbarer Deckel, dieser lässt sich spielend leicht öffnen und schließen, der Lauf des Deckels wird professionell gedämpft.

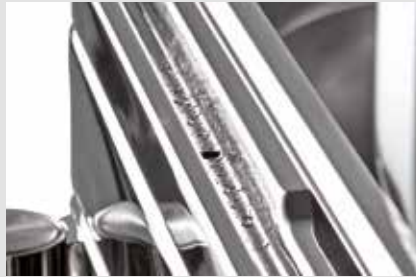

### Kondenswasser - Rücklaufsystem

Kondenswasser wird in das Wasserbecken zurückgeführt.



### Sandwichboden / Kapselboden

Induktionsfähiger Boden, direkt auf dem Induktionskochfeld einsetzbar. Perfekte Wärmeverteilung und Steuerung.



### Fixierschraube / Rutschsicherung

Höhenverstellbares Gelenk, fixiert das Gerät in dem Gestell und auf dem Tisch.



### Induktionskochplatte Nr. 12295

Induktionskochplatte wird einfach in das Gestell gelegt.



### stapelbar

Chafing Dish Rahmen sind übereinander stapelbar. Platzsparend und rutschfest stapeln und transportieren.



### Induktionskochplatte für Chafing Dish

induction plate for chafing dish  
placa de inducción para chafing dish  
plaque à induction pour chafing dish

mit Regler  
with power control  
con control de potencia  
avec régulateur

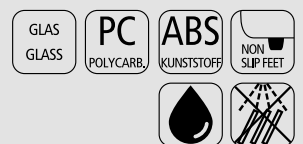

	Ø cm		€
12295	24	900 W	139,00



12370

**Lieferung ohne Induktionskochplatte**  
delivery without induction plate  
se entrega sin placa de inducción  
livré sans plaque à induction

GN 1/1 Chafing Dish „PREMIUM“



1 Gestell + 1 Wasserbecken mit Sandwichboden + 1 Wasserbeckenrahmen + 1 Deckel mit hydraulischem Gelenk + 1 GN 1/1 Behälter 65 mm tief, hitzebeständige Griffe, hochwertige Verarbeitung, ausschließlich für Induktionskochfelder

1 frame + 1 waterpan with sandwich base + 1 frame for waterpan + 1 hydraulic cover + 1 GN 1/1 container 65 mm, heat resistant handles, high quality, only for induction plates

1 soporte + 1 cubeta baño maría con base sandwich + 1 marco para cubeta baño maría + 1 tapa hidráulica + 1 cubeta GN 1/1 de 65 mm, asas resistentes al calor, acabado de alta calidad, solamente para inducción

1 pied support + 1 bac bain-marie avec fond sandwich + 1 cadre pour bac bain-marie + 1 couvercle hydraulique + 1 bac GN 1/1 de 65 mm, poignées résistantes à la chaleur, finition de qualité, uniquement pour induction

	cm	↑ cm	ltr.		€
12370	66 x 48	33	9	mit Edelstahldeckel with stainless steel cover	894,00
12352	66 x 48	33	9	mit Glasdeckel with glass cover	1140,00



12353

**Lieferung ohne Induktionskochplatte**  
delivery without induction plate  
se entrega sin placa de inducción  
livré sans plaque à induction

Chafing Dish rund „PREMIUM“



1 Gestell + 1 Wasserbecken mit Sandwichboden + 1 Wasserbeckenrahmen + 1 Deckel mit hydraulischem Gelenk + 1 runder Speisenbehälter, hitzebeständiger Griff, hochwertige Verarbeitung, ausschließlich für Induktionskochfelder

1 frame + 1 waterpan with sandwich base + 1 frame for waterpan + 1 hydraulic cover + 1 round foodpan, heat resistant handle, high quality, only for induction plates

1 soporte + 1 cubeta baño maría con base sandwich + 1 marco para cubeta baño maría + 1 tapa hidráulica + 1 cubeta redonda, asa resistente al calor, acabado de alta calidad, solamente para inducción

1 pied support + 1 bac bain-marie avec fond sandwich + 1 cadre pour bac bain-marie + 1 couvercle hydraulique + 1 bac rond, poignée résistante à la chaleur, finition de qualité, uniquement pour induction

	cm	↑ cm	ltr.		€
12371	44 x 54	33	6	mit Edelstahldeckel with stainless cover	780,00
12353	44 x 54	33	6	mit Glasdeckel with glass cover	890,00

Speiseneinsatz / foodpan / cubeta / bac supérieur

	€
12366	24,00



12372

**Lieferung ohne Induktionskochplatte**  
delivery without induction plate  
se entrega sin placa de inducción  
livré sans plaque à induction

Chafing Dish rund „PREMIUM“



1 Gestell + 1 Wasserbecken mit Sandwichboden + 1 Wasserbeckenrahmen + 1 Deckel mit hydraulischem Gelenk + 1 runder Speisenbehälter, hitzebeständige Griffe, hochwertige Verarbeitung, ausschließlich für Induktionskochfelder

1 frame + 1 waterpan with sandwich base + 1 frame for waterpan + 1 hydraulic cover + 1 round foodpan, heat resistant handles, high quality, only for induction plates

1 soporte + 1 cubeta baño maría con base sandwich + 1 marco para cubeta baño maría + 1 tapa hidráulica + 1 cubeta redonda, asas resistentes al calor, acabado de alta calidad, solamente para inducción

1 pied support + 1 bac bain-marie avec fond sandwich + 1 cadre pour bac bain-marie + 1 couvercle hydraulique + 1 bac rond, poignées résistantes à la chaleur, finition de qualité, uniquement pour induction

	cm	↑ cm	ltr.		€
12372	44 x 48	39	10	mit Edelstahldeckel with stainless cover	780,00
12354	44 x 48	39	10	mit Glasdeckel with glass cover	890,00

Speisenbehälter / foodpan / cubeta superior / bac supérieur

	€
12397	22,00

# GLOBE



die Deckelbremse sorgt für langsames Schließen  
 the revolving cover closes gently, thanks to a special built-in axle  
 sistema de freno para un cierre suave de la tapa  
 système avec frein pour une fermeture en douceur du couvercle



abnehmbarer Glas-Deckel mit Wasserrücklaufsystem  
 removable glas lid, with water-runback-system  
 tapa transparente desmontable con sistema de retorno de la condensación  
 couvercle transparent amovible avec système de retour de la condensation



Kondenswasser wird in das Wasserbecken zurückgeführt  
 condensed water is led back into the waterpan  
 el agua de condensación vuelve a la cubeta de agua  
 l'eau de condensation retourne dans le bac d'eau



für alle Herdarten geeignet, auch für Induktionskochplatten  
 suitable for all kinds of ovens, even induction cookers  
 apto para todas las fuentes de calor, incluso inducción  
 apte pour toutes les sources de chaleur, y compris induction



## Induktionskochplatte für Chafing Dish

induction plate for chafing dish  
 placa de inducción para chafing dish  
 plaque à induction pour chafing dish

mit Regler  
 with power control  
 con control de potencia  
 avec régulateur

	Ø cm		€
12295	24	900 W	139,00



GN 1/1 Chafing Dish „GLOBE“

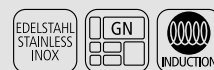

hochglanzpoliert, mit abnehmbarem hydraulischem Edelstahl-Deckel, Sandwichboden sorgt für optimale Wärmeleitung, für Induktionsplatten geeignet, Set: Gestell + Wasserbecken + Speisenbehälter GN 1/1 65 mm tief, 9 Liter + Löffelablage + 2 Brennpastenbehälter + Metallrahmen für Induktionskochplatte

mirror polished finish, removable stainless steel hydraulic cover, sandwich base for optimum heat distribution, suitable for induction plates

set: frame + waterpan + GN 1/1 container 65 mm, 9l + cutlery compartment ladles + 2 burner holder + frame for induction plate

pulido brillante, tapa hidráulica de acero inoxidable extraíble, fondo difusor sandwich apto para inducción, incluye: soporte + cubeta baño maría + cubeta GN 1/1 de 65 mm, 9 l + soporte para cuchara (sin cuchara) + 2 quemadores + marco para la placa de inducción

poli brillant, couvercle inox hydraulique amovible, fond diffuseur sandwich apte pour induction, comprend: pied support + bac bain-marie + bac GN 1/1 de 65 mm, 9 l + porte-louche (louche non incluse) + 2 brûleurs + cadre inox pour la plaque à induction



12394



12404



12295



12296

	cm	↑ cm	ltr.		€
12394	66,5 x 44	34	9	mit Edelstahldeckel with stainless cover	624,00
12404	66,5 x 44	34	9	mit Glasdeckel with glass cover	624,00

Induktionskochplatte für Chafing Dish / induction plate for chafing dish / placa de inducción para chafing dish / plaque à induction pour chafing dish

	€
12295	139,00

Metallrahmen für Induktionskochplatte / frame for induction plate / estructura o marco para placa de inducción / cadre support inox pour plaque induction

	€
12296	19,40



GN 2/3 Chafing Dish „GLOBE“



hochglanzpoliert, mit abnehmbarem hydraulischem Edelstahl-Deckel, Sandwichboden sorgt für optimale Wärmeleitung, für Induktionsplatten geeignet, Set: Gestell + Wasserbecken + 1 GN 2/3 Behälter 65 mm tief + Löffelablage + 1 Brennpastenbehälter + 1 Metallrahmen für Induktionskochplatte

mirror polished finish, removable hydraulic cover, sandwich base, optimum heat distribution, set: frame + waterpan + foodpan GN 2/3, 65 mm, 5,5 l + compartment for ladles + burner holder + frame for induction plate

pulido brillante, con tapa hidráulica extraíble, fondo difusor sandwich apto para inducción. Incluye: 1 pie, 1 cubeta baño maria, 1 cubeta GN 2/3 65 mm - 5,5 l, 1 soporte para cuchara (sin cuchara), 1 quemador, marco inox para la placa de inducción

poli brillant, couvercle hydraulique amovible, fond diffuseur sandwich apte pour induction. Comprend: pied, cuve bain-marie, bac inox GN 2/3-65 mm - 5,5 L, porte-louche (louche non incluse), brûleur, cadre inox pour la plaque à induction

	cm	↑ cm	ltr.		€
12483	44 x 41	34	5,5	mit Edelstahl-Deckel with stainless steel cover	560,00
12484	44 x 41	34	5,5	mit Glasdeckel with glass cover	560,00



Chafing Dish „GLOBE“



hochglanzpoliert, mit abnehmbarem hydraulischen Edelstahl-Deckel, Sandwichboden sorgt für optimale Wärmeleitung, für Induktionsplatten geeignet

Set: Gestell + Wasserbecken + Speisenbehälter rund + Löffelablage + Brennpastenbehälter + Metallrahmen für Induktionskochplatte

mirror polished finish, removable hydraulic cover, sandwich base, optimum heat distribution, set: frame + waterpan + foodpan round + cutlery compartment ladles + burner holder + frame for induction plate

pulido brillante, con tapa hidráulica extraíble, fondo difusor sandwich apto para inducción. Incluye: 1 pie, 1 cubeta baño maria, 1 cubeta redonda, 1 soporte para cuchara (sin cuchara), 1 quemador, marco inox para la placa de inducción

brillant, couvercle hydraulique amovible, fond diffuseur sandwich apte pour induction.

Comprend: pied, cuve bain-marie, bac inox rond, porte-louche (louche non incluse), 1 brûleur, cadre inox pour la plaque à induction

	Ø cm	↑ cm	ltr.		€
12393	38,5	34	6	mit Edelstahldeckel with stainless cover	532,00
12403	38,5	34	6	mit Glasdeckel with glass cover	540,00

Induktionskochplatte für Chafing Dish / induction plate for chafing dish / placa de inducción para chafing dish / plaque à induction pour chafing dish

	€
12295	139,00

Metallrahmen für Induktionskochplatten / frame for induction plate / marco para placa de inducción / cadre support inox pour plaque induction

	€
12291	18,30

Speiseneinsatz / foodpan / cubeta / bac supérieur

	€
12366	24,00

Porzellan-Einsatz / porcelain insert / bandeja de porcelana / bac supérieur en porcelaine

	Ø cm	↑ cm	ltr.	fits to	€
82210	39	6	4,3	12393, 12403	82,00
82215	39	6	4,0	12393, 12403	84,00



**Suppen-Kugel inkl. Gestell „GLOBE“**

soup bowl with stand  
cubeta sopa con soporte  
récipient à soupe avec pied

hochglanzpoliert, inkl. Speisenbehälter, 1 Brennpastenbehälter, mit einhängbarer Löffelablage, Sandwichboden sorgt für optimale Wärmeverteilung, für Induktionsplatten geeignet, einfaches Anbringen und Entfernen des Deckels, hitzeisolierende Griffe, 1 Metallrahmen für Induktionskochplatten

mirror polished finish, incl. foodpan and 1 burner holder, with fitting compartment for ladles, sandwich bottom for optimum heat distribution, gentle opening of the lid, heat-resistant handles, frame for induction plate

acabado pulido brillante, cubeta sopa inox, 1 quemador, platillo a colgar para el cucharón, fondo difusor sandwich, apto para inducción, tapa con apertura controlada, asas frías, marco para placa de inducción

poli brillant, récipient à soupe inox, 1 brûleur, repose-couvert à accrocher, fond diffuseur sandwich, apte pour induction, couvercle à ouverture contrôlée, anses froides, cadre support inox pour plaque à induction



	Ø cm	↑ cm	ltr.	€
12398	48	45	10	490,00

**Induktionskochplatte für Chafing Dish / induction plate for chafing dish / placa de inducción para chafing dish / plaque à induction pour chafing dish**

12295	139,00
-------	--------

**Metallrahmen für Induktionskochplatten / frame for induction plate / marco para placa de inducción / cadre support inox pour plaque induction**

12291	18,30
-------	-------



**Suppen-Kugel „GLOBE“**

soup bowl  
cubeta sopa  
récipient à soupe

hochglanzpoliert, inkl. Speisenbehälter, mit einhängbarer Löffelablage, Sandwichboden sorgt für optimale Wärmeverteilung, für Induktionsplatten geeignet, einfaches Anbringen und Entfernen des Deckels, hitzeisolierende Griffe (Lieferung ohne Gestell, Löffel)

mirror polished finish, incl. foodpan, with fitting compartment for ladles, sandwich bottom for optimum heat distribution, gentle opening of the lid, heat-resistant handles (delivery without rack, ladle)

acabado pulido brillante, cubeta sopa inox, platillo a colgar para el cucharón, fondo difusor sandwich, apto para inducción, tapa con apertura controlada, asas frías (cucharón no incluido)

poli brillant, récipient à soupe inox, repose-couvert à accrocher, fond diffuseur sandwich, apte pour induction, couvercle à ouverture contrôlée, anses froides (cadre, louche non incluse)



	Ø cm	↑ cm	ltr.	€
12399	48	32	10	420,00

**Gestell inkl. Brenner / frame incl. burner / soporte incluyendo quemador / support, brûleur inclus**

12396	90,00
-------	-------

**Speisenbehälter / foodpan / cubeta superior / bac supérieur**

12397	22,00
-------	-------

# EASY INDUCTION



die Deckelbremse sorgt für langsames Schließen

the revolving cover closes gently, thanks to a special built-in axle

sistema de freno para un cierre suave de la tapa

système avec frein pour une fermeture en douceur du couvercle



Druckhebel zum leichten Entnehmen des GN-Behälters

stick for easy removing of the GN-container

dispositivo para levantar y quitar con facilidad la cubeta GN

dispositif pour lever et retirer facilement le bac GN



abnehmbarer Glas-Deckel mit Wasserrücklaufsystem

removable glas lid, with water-runback-system

tapa transparente desmontable con sistema de retorno de la condensación

couvercle transparent amovible avec système de retour de la condensation



Fixierschraube verhindert das Rutschen

fixing screw for skid resistance

Pie trasero anti-deslizante, altura regulable

Pied supplémentaire anti-dérapant réglable en hauteur



Lieferung ohne Induktionskochplatte  
delivery without induction plate  
se entrega sin placa de inducción  
livré sans plaque à induction

## GN 1/1 Chafing Dish „EASY INDUCTION“



1 Gestell + 1 Wasserbecken mit Sandwichboden + 1 Deckel mit hydraulischem Gelenk + 1 GN 1/1 Behälter 65 mm tief, hitzebeständige Griffe, hochwertige Verarbeitung, ausschließlich für Induktionskochfelder

1 frame + 1 waterpan with sandwich base + 1 hydraulic cover + 1 GN 1/1 container 65 mm, heat-resistant handles, high quality, only for induction plates

1 marco + 1 baño maría con base sandwich + 1 marco con tapa hidráulica + 1 cubeta GN 1/1 pan 65 mm profundo, asas resistentes al calor, buenos acabados, solamente para inducción

1 pied support + 1 bac bain-marie avec fond sandwich + 1 cadre avec couvercle hydraulique + 1 bac GN 1/1 - 65mm, poignées résistantes à la chaleur, belle qualité, uniquement pour induction

	cm	↑ cm	GN	ltr.	€
12322	60 x 42	30	1/1	9	500,00



Lieferung ohne Induktionskochplatte  
delivery without induction plate  
se entrega sin placa de inducción  
livré sans plaque à induction

## GN 2/3 Chafing Dish „EASY INDUCTION“



1 Gestell + 1 Wasserbecken mit Sandwichboden + 1 Wasserbeckenrahmen + 1 Deckel mit hydraulischem Gelenk + 1 GN 2/3 Behälter 65 mm tief, hitzebeständige Griffe, hochwertige Verarbeitung, ausschließlich für Induktionskochfelder

1 frame + 1 waterpan with sandwich base + 1 frame for waterpan + 1 hydraulic cover + 1 GN 2/3 container 65 mm, heat-resistant handles, high quality, only for induction plates

1 marco + 1 baño maría con base sandwich + 1 marco con tapa hidráulica + 1 cubeta GN 2/3 pan 65 mm profundo, asas resistentes al calor, buenos acabados, solamente para inducción

1 pied support + 1 bac bain-marie avec fond sandwich + 1 cadre avec couvercle hydraulique + 1 bac GN 2/3 - 65mm, poignées résistantes à la chaleur, belle qualité, uniquement pour induction

	cm	↑ cm	GN	ltr.	€
12323	42 x 41	30	2/3	5,5	420,00





**Lieferung ohne Induktionskochplatte**  
delivery without induction plate  
se entrega sin placa de inducción  
livré sans plaque à induction

### Chafing Dish „EASY INDUCTION“



1 Gestell + 1 Wasserbecken mit Sandwichboden + 1 Deckel mit hydraulischem Gelenk  
+ 1 runder Speisenbehälter, hitzebeständige Griffe, hochwertige Verarbeitung,  
ausschließlich für Induktionskochfelder geeignet

1 frame + 1 waterpan with sandwich base + 1 hydraulic cover + 1 round foodpan,  
heat-resistant handles, high quality, good for induction plates

1 soporte + 1 baño maría con base sandwich + 1 tapa hidráulica + 1 cubeta redonda,  
asas resistente al calor, buen acabado, apto para inducción

1 pied support + 1 bac bain-marie avec fond sandwich + 1 cadre avec couvercle hydraulique +  
1 bac rond, poignées résistantes à la chaleur, belle qualité, uniquement pour induction

	cm	↑ cm	ltr.	€
12324	46 x 50	30	6	410,00



**Lieferung ohne Induktionskochplatte**  
delivery without induction plate  
se entrega sin placa de inducción  
livré sans plaque à induction

### Chafing Dish „EASY INDUCTION“



1 Gestell + 1 Wasserbecken mit Sandwichboden + 1 Deckel mit hydraulischem Gelenk +  
1 runder Speisenbehälter, hitzebeständige Griffe, hochwertige Verarbeitung,  
ausschließlich für Induktionskochfelder geeignet

1 frame + 1 waterpan with sandwich base + 1 hydraulic cover + 1 round foodpan,  
heat-resistant handles, high quality, good for induction plates

1 soporte + 1 baño maría con base sandwich + 1 tapa hidráulica + 1 cubeta redonda,  
asas resistente al calor, buen acabado, apto para inducción

1 pied support + 1 bac bain-marie avec fond sandwich + 1 cadre avec couvercle hydraulique +  
1 bac rond, poignées résistantes à la chaleur, belle qualité, uniquement pour induction

	cm	↑ cm	ltr.	€
12325	48 x 42	39	11	410,00



### Induktionskochplatte für Chafing Dish

induction plate for chafing dish  
placa de inducción para chafing dish  
plaque à induction pour chafing dish

mit Regler

with power control

con control de potencia

avec régulateur

	Ø cm		€
12295	24	900 W	139,00



82210  
4,3 ltr.

82215  
2 x 2 ltr.

### Porzellan-Einsatz

porcelain insert  
bandeja de porcelana  
bac supérieur en porcelaine



	Ø cm	↑ cm	ltr.	fits to	€
82210	39	6	4,3	12324, 12393, 12403	82,00
82215	39	6	4,0	12324, 12393, 12403	84,00

## CHAFING DISHES



### Rolltop-Chafing Dish „ELITE“



poliert, Rolltopdeckel klappbar auf 90° und 180°, Speisenbehälter GN 1/1 65 mm tief + Wasserbecken + 2 Brennpastenbehälter, wechseln des GN-Behälters ohne Abnehmen des Deckels (kein Kondenswasser-Rücklaufsystem)

polished, rolltop cover adjustable at 90° and 180°, foodpan GN 1/1 65 mm deep + waterpan + 2 burner holders, change of the GN container without removing the lid (condensed water can not be led back into the waterpan)

pulido brillante, tapa rolltop a 90° o 180°, cubeta GN 1/1 + 2 quemadores, cuba baño maría, se puede cambiar la cubeta GN sin retirar la tapa, importante: el agua condensada no revierte en los alimentos

poli brillant, couvercle rolltop ouverture de 90 a 180°, bac GN 1/1, bain-marie, 2 brûleurs, le bac GN peut être retiré et remplacé sans démonter le couvercle, important: la condensation ne retombe pas sur les aliments

	cm	↑ cm	ltr.	€
12350	67 x 47	45	9	250,00

Wasserbecken inkl. Vorrichtung für Heizelement / waterpan / baño maría / bain-marie

12249				49,00
-------	--	--	--	-------



inkl. Vorrichtung für Heizelement  
incl. screws for heating unit



### Rolltop-Chafing Dish „CATERER“



Speisenbehälter GN 1/1 65 mm tief + Rolltopdeckel 90° + Wasserbecken inkl. Vorrichtung für Heizplatte + 2 Brennpastenbehälter (Lieferung ohne Heizplatte), massiver Ständer

foodpan GN 1/1 65 mm deep + rolltop cover 90° + waterpan with screws for heatingunit + 2 burner holders (without heating unit), stable frame

1 cubeta GN 1/1 - 65 mm + campana rolltop abatible a 90° + 2 quemadores + cuba baño maría con fijaciones para resistencia amovible (se sirve sin la resistencia)

1 bac GN 1/1 - 65 mm + couvercle rolltop ouverture 90° + 2 brûleurs + 1 bac bain-marie avec 4 vis pour fixation résistance de chauffe amovible (non incluse)

	cm	↑ cm	ltr.	€
12245	67 x 35	45	9	228,00

Wasserbecken inkl. Vorrichtung für Heizelement / waterpan / baño maría / bain-marie

12249				49,00
-------	--	--	--	-------

inkl. Vorrichtung  
für Heizelement  
incl. screws  
for heating unit



### Rolltop-Chafing Dish „MAESTRO“



Speisenbehälter GN1/1 65 mm tief (passend auch für 100 mm) + Rolltopdeckel 90° + Wasserbecken inkl. Vorrichtung für Heizplatte + 2 Brennpastenbehälter

foodpan GN1/1 65 mm (also for 100 mm) + rolltop cover 90° + waterpan with screws for heating unit + 2 burner holders

cubeta GN 1/1 - 65 mm (hay espacio para una cubeta 100 mm) + campana rolltop abatible a 90° + 2 quemadores

bac GN 1/1 - 65 mm (accepte aussi bac ht. 100 mm) + couvercle rolltop ouverture 90° + 2 brûleurs

	cm	↑ cm	ltr.	€
12300	67 x 35	45	9	200,00

Rolltopdeckel 90°  
rolltop cover 90°



**Chafing Dish „CATERER PRO“**



Deckel hochglanzpoliert, Deckelgriffe hitzebeständig + 2 Brennpastenbehälter + Wasserbecken, inkl. Vorrichtung für Heizplatte + Gestell mit Deckelhalterung (ohne GN Speisenbehälter)  
 cover mirror polished finish, cover knob heat-resistant + 2 burner holders  
 + waterpan with screws for heating unit + frame with coverholder (without GN foodpan)  
 tapa pulido brillante, asas frías + 2 quemadores + cuba inferior con tornillos para resistencia  
 removible (no incluida) + tapa y estructura con sujeción de la tapa (se sirve sin la cubeta GN)  
 couvercle poli brillant, anses froides + 2 brûleurs + bac bain-marie  
 avec fixations pour résistance amovible (non incluse)

	cm	↑ cm	€
12233	64 x 35	34	150,00

**Ersatzdeckel / replacement cover / tapa de recambio / couvercle de rechange**

	€
12236	52,00

**Wasserbecken inkl. Vorrichtung für Heizelement / waterpan / baño maría / bain-marie**

	€
12249	49,00



**Chafing Dish „CHEF“**



Speisenbehälter GN 1/1 65 mm tief + 2 Brennpastenbehälter  
 + Wasserbecken + Deckel + Gestell mit Deckelhalterung + langer Hohlgriff  
 foodpan GN 1/1 65 mm + 2 burner holders + waterpan  
 + cove + frame with coverholder  
 1 cubeta GN 1/1 65 mm + 2 quemadores + cubeta para el agua  
 + tapa y chasis con bloqueo para la tapa  
 1 bac GN 1/1 - 65 mm + 2 brûleurs + 1 bac bain-marie  
 + couvercle + chassis avec blocage couvercle + poignée tube creux

	cm	↑ cm	ltr.	€
11675	61 x 31	30	9	72,00



**Brennpastenbehälter**

burner holder  
 soporte para quemador  
 porte-brûleur



**nachfüllbar, für Chafing Dish, Deckel mit Bajonettverschluss**

refillable, for Chafing Dish, lid with bayonet lock  
 recargable, para Chafing Dish, tapa con cierre de bayoneta  
 rechargeable, pour chafing dish, couvercle avec verrouillage par baïonnette

	Ø cm	↑ cm	€
11683	9	6	6,30

## CHAFING DISHES



### Elektro-Rolltop-Chafing Dish „ELITE“

electric rolltop chafing dish  
chafing dish eléctrico rolltop  
chafing dish électrique rolltop



Rolltopdeckel poliert, klappbar auf 90° und 180°, Elektro-Wasserbecken mit Temperaturregelung + Speisenbehälter GN 1/1 100 mm tief, 760 - 900 W, 230 V (kein Kondenswasser-Rücklaufsystem)

rolltop cover polished, adjustable at 90° and 180°, electric waterpan with adjustable heatcontrol + foodpan GN 1/1 100 mm deep, 760 - 900 W, 230 V (condensed water cannot be led back into the waterpan)

tapa abatible pulido brillante, apertura a 90° o 180°, baño maría c/ termostato + cubeta GN 1/1 - 100 mm, 760 - 900 W, 230 V (el agua condensada no gotea dentro de la cubeta)

couvercle rolltop poli brillant, ouverture à 90° ou 180°, bain-marie électrique avec thermostat + bac GN 1/1-100 mm, 760 - 900 W, 230 V (Important: la condensation ne retombe pas sur les aliments)

	cm	↑ cm	ltr.	€
12360	67 x 47	45	14	395,00

Wasserbecken, elektrisch / electric waterpan / baño maria eléctrico / bain-marie électrique

12224				82,00
-------	--	--	--	-------



### Elektro Chafing Dish

electric chafing dish  
chafing dish eléctrico  
chafing dish électrique



Deckel poliert, Elektro-Wasserbecken mit Temperaturregelung + Speisenbehälter GN 1/1 100 mm tief, Deckelhalter, 900 W, 230 V

cover polished, electric waterpan with adjustable heatcontrol + foodpan GN 1/1 100 mm deep, lid holder, 900 W, 230 V

tapa pulido brillante, baño maría c/ termostato + cubeta GN 1/1 - 100 mm, sujeción de la tapa, 900 W, 230 V

couvercle poli brillant, bain-marie électrique avec thermostat + bac GN 1/1-100 mm, blocage du couvercle, 900 W, 230 V

	cm	↑ cm	ltr.	€
12225	63 x 36	29	14	170,00

Deckel / cover / tapa / couvercle

12235				35,00
-------	--	--	--	-------

Wasserbecken, elektrisch / electric waterpan / baño maria eléctrico / bain-marie électrique

12224				82,00
-------	--	--	--	-------



### Elektro-Chafing Dish „ECO“

electric chafing dish  
chafing dish eléctrico  
chafing dish électrique



Deckel poliert, Elektro-Wasserbecken mit Temperaturregelung + Speisenbehälter GN 1/1 65 mm tief, Deckelhalter, 760 - 900 W, 230 V

cover polished, electric waterpan with adjustable heatcontrol + foodpan GN 1/1 65 mm deep, lid holder, 760 - 900 W, 230 V

tapa pulido brillante, baño maría c/ termostato + cubeta GN 1/1 - 65 mm, sujeción de la tapa, 760 - 900 W, 230 V

couvercle poli brillant, bain-marie électrique avec thermostat + bac GN 1/1 - 65 mm, blocage du couvercle, 760 - 900 W, 230 V

	cm	↑ cm	ltr.	€
12232	63 x 36	29	9	139,00

Wasserbecken, elektrisch / electric waterpan / baño maria eléctrico / bain-marie électrique

12224				82,00
-------	--	--	--	-------





**Elektrischer Suppentopf**

electric soup warmer  
marmita de sopa eléctrica  
marmite à soupe électrique



herausnehmbarer Einsatz aus Edelstahl, elektrisch, mit Wasserbad + Löffel + integrierter Tragering für den Innenbehälter, Deckel mit hitzeisolierendem Griff, Temperaturregelung 80°C (± 10°C), 450 - 550 W, 230 V

removable soup st. steel pan, bain marie electric, ladle, circular frame, thermostat control till 80°C (± 10°C), 450 - 550 W, 230 V  
recipiente sopa inox extraible, baño maria eléctrico + cucharón + aro inox, tapa con asas frías, termostato hasta 80°C precisión (± 10°C), 450 - 550 W, 230 V  
récipient à soupe inox amovible, bain-marie électrique, louche, support circulaire inox, thermostat maxi 80°C (± 10°C), 450 - 550 W, 230 V

	Ø cm	↑ cm	ltr.	€
11901	38	36,5	10	148,00



**Elektrischer Suppentopf**

electric soup warmer  
marmita de sopa eléctrica  
marmite à soupe électrique



herausnehmbarer Einsatz aus Edelstahl, elektrisch, mit Wasserbad + Löffel + integrierter Tragering für den Innenbehälter, Deckel mit hitzeisolierendem Griff, Temperaturregelung 80°C (± 10°C), 400 - 450 W, 230 V

removable soup st. steel pan, bain marie electric, ladle, st. steel circular frame, thermostat control till 80°C (± 10°C), 400 - 450 W, 230 V  
recipiente sopa inox extraible, baño maria eléctrico + cucharón + aro inox, tapa con asas frías, termostato hasta 80°C precisión (± 10°C), 400 - 450 W, 230 V  
récipient à soupe inox amovible, bain-marie électrique, louche, support circulaire inox, thermostat maxi 80°C (± 10°C), 400 - 450 W, 230 V

	Ø cm	↑ cm	ltr.	€
11910	40	37	10	148,00



**Elektrischer Suppentopf „ECONOMIC“**

electric soup warmer  
marmita de sopa eléctrica  
marmite à soupe électrique



Stahl schwarz lackiert, herausnehmbarer Einsatz aus Edelstahl, mit Wasserbad, Temperaturregelung 30°C - 90°C, dreh- und klappbarer Edelstahl-Deckel, inkl. 8 magnetisch haftenden Beschriftungen, 400 W, 230 V

metal, black, removable soup pot, with bain marie, thermostat 30°C - 90°C, st. steel lid, incl. 8 magnetic signs, 400 W, 230 V  
metal negro, recipiente sopa inox extraible, con baño maria, termostato 30°C- 90°C, tapa inox, incluye 8 letreros magnéticos, 400 W, 230 V  
acier, noir, récipient à soupe inox amovible, avec bain-marie, thermostat 30°C - 90°C, couvercle inox, 8 étiquettes magnétiques, 400 W, 230 V

	Ø cm	↑ cm	ltr.	€
11915	32	36	9	104,00

Speisenbehälter / foodpan / recipiente sopa / récipient à soupe

11916	28,00
-------	-------

Deckel / cover / tapa / couvercle

11917	15,40
-------	-------

# CHAFING DISHES

4 tlg.  
4 pcs.



12330



12335



12336



12337



12338



12339



82211

## Chafing Dish, 4-teiliges Set

chafing dish set, 4 pcs.  
chafing dish, set de 4  
chafing dish, set de 4



### 4-teiliges Set:

- 1 Topf (8 Liter)
- 1 Speisenbehälter (4 Liter)
- 1 Deckel mit Sichtfenster und 1 Deckelbremse
- Topf mit induktionsfähigem Sandwich- / Kapselboden

### 4 pcs. set:

- 1 pot (8 litres),
- 1 foodpan (4 litres)
- 1 lid with glass insert and 1 automatic lid brake
- pot with induction-compatible sandwich base

### set de 4:

- 1 olla (8 litros)
- 1 cubeta (4 litros)
- 1 tapa con ventanilla y 1 sistema de freno en la tapa
- olla con base sandwich apta para inducción

### set de 4:

- 1 casserole (8 litres)
- 1 bac (4 litres)
- 1 couvercle avec fenêtre et 1 système de frein dans le couvercle
- casserole avec fond sandwich pour induction

	Ø cm	↑ cm	ltr.	Farbe / Colour		€/ set
12330	30,5	17,5	4		stainless	260,00
12335	30,5	17,5	4		copper	314,00
12336	30,5	17,5	4		yellow	314,00
12337	30,5	17,5	4		red	314,00
12338	30,5	17,5	4		black	314,00
12339	30,5	17,5	4		green	314,00

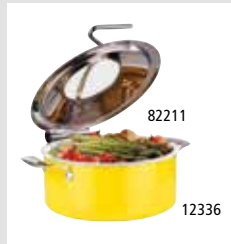

82211

12336



abnehmbarer Deckel  
removable lid

induktionsgeeignet  
suitable for induction

Ersatz-Speisenbehälter zu Chafing Dish / replacement foodpan for chafing dish / cubeta interior de repuesto para chafing dish / bac intérieur de remplacement pour le chafing dish

	Ø cm	↑ cm	ltr.	fits to	€
12329	30,5	8	4	12330, 12335, 12336, 12337, 12338, 12339	30,00



Ø 33 cm



Sandwich- / Kapsel-  
boden / sandwich base



12329

Ø 30,5 cm

4 ltr. Speisenbehälter  
4 ltr. foodpan



Deckelbremse  
automatic lid break

## Porzellaneinsatz

porcelain insert  
bandeja de porcelana  
bac en porcelaine



	Ø cm	↑ cm	ltr.	fits to	€
82211	29,5	9	3	12330, 12335, 12336, 12337, 12338, 12339	62,00



inklusive  
Induktionskochplatte  
900 Watt



**NEW** Kochplatte Ø 24 cm  
induction station Ø 24 cm **4 tlg.**  
4 pcs.

**Induktionsstation, 4-tlg. Set**  
induction station, 4 pcs.  
estación de inducción, set de 4  
station d'induction, set de 4



4 teiliges Set:

- 1 Induktionskochplatte mit Regler (Ø 24 cm, 900 Watt)
- 1 Metallständer schwarz
- 1 Rahmen aus Eiche (wasserfest lackiert)
- 1 Edelstahlrahmen

4 pcs. set:

- 1 induction hotplate with controller (Ø 24 cm, 900 watt)
- 1 metal stand black
- 1 frame made of oak (water-resistant coated)
- 1 stainless steel frame

set de 4:

- 1 placa de inducción con regulador (Ø 24 cm, 900 vatios)
- 1 soporte de metal negro
- 1 caja de roble (con recubrimiento resistente al agua)
- 1 marco de acero inoxidable

set de 4:

- 1 plaque d'induction avec température réglable (Ø 24 cm, 900 watts)
- 1 support métallique noir
- 1 cadre en chêne (verni résistant à l'eau)
- 1 cadre en acier inox

	cm	↑ cm	€
12275	35,4 x 32,5	19	224,00



passendes Chafing Dish Set 12339  
suitable chafing dish set 12339

Ersatzteile / replacement parts / piezas de repuesto / pièces de rechange

	cm	↑ cm		€
12276	35,4 x 32,5	8,5	Holzrahmen / wooden frame	72,00
12272	29,5 x 26,5	1	Edelstahlrahmen / stainless steel frame	22,00
12295	Ø 24	-	900 Watt Induktionskochplatte / induction plate	139,00
15506	35,4 x 32,5	17,6	Buffetständer schwarz / buffet stand black	22,80



**NEW**

**Induktionsstation, 2-tlg. Set**

Induction station, 2-piece set  
Estación de inducción, juego de 2 piezas  
Station à induction, set de 2 pièces



Set, bestehend aus Induktionkochplatte 2000 Watt (no. 12285), inklusive Kabel-Fernbedienung, Leistung in Stufen regelbar, Rahmen aus Eichenholz (wasserfest lackiert) (no. 14051)

set consists of induction hotplate 2000 Watt, cable remote control, power adjustable in steps, frame made of oak (waterproof lacquered)

set, compuesto por placa de inducción 2000 Watt (no. 12285), incluye mando a distancia por cable, potencia regulable en pasos, madera de roble (lacado impermeable)

set, composé d'une plaque de cuisson à induction 2000 watts (no. 12285), télécommande filaire incluse, puissance réglable par paliers, bois de chêne (vernis imperméable)

	cm	↑ cm		€
14050	39 x 39	10	2000 W	264,00



**Einbau-Induktionskochplatte für Chafing Dish**

built-in induction plate for chafing dish  
placa de inducción para empotrar  
plaque à induction à encastrer

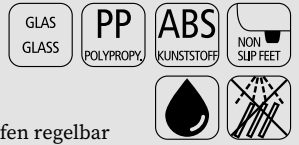

inkl. Kabel-Fernbedienung, energiesparend, Leistung in 5 Stufen regelbar

incl. cable remote control, energy-saving, power adjustable in 5 steps  
incl. mando a distancia con cable, ahorro energético, potencia regulable en 5 pasos  
y compris télécommande filaire, économe en énergie, puissance réglable en 5 étapes

	cm	↑ cm		€
12285	35,5 x 35,5	6	2000 W	210,00



**Induktionskochplatte für Chafing Dish**

induction plate for chafing dish  
placa de inducción para chafing dish  
plaque à induction pour chafing dish

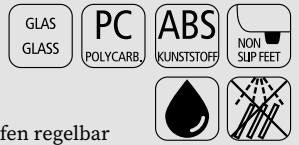

inkl. Kabel-Fernbedienung, energiesparend, Leistung in 5 Stufen regelbar

incl. cable remote control, energy-saving, power adjustable in 5 steps  
incl. mando a distancia con cable, ahorro energético, potencia regulable en 5 pasos  
y compris télécommande filaire, économe en énergie, puissance réglable en 5 étapes

	Ø cm		€
12295	24	900 W	139,00



**Metallrahmen für Induktionskochplatten**

frame for induction plate  
marco para placa de inducción  
cadre support inox pour plaque induction



		€
12291	für runde Chafer / for round chafing dish	18,30
12296	für Chafer GN 1/1 / for GN 1/1 chafing dish	19,40



**Elektro-Heizelement**

heating unit  
resistencia  
résistance



mit einstellbarem Leistungsregler / adjustable heat control / abiertos con termostato /  
contrôle de la chaleur réglable

			€
12292	600 W / 230 V	for chafer covers are <u>closed</u> most of the time	136,00
12294	800 W / 230 V	for chafer covers are <u>open</u> most of the time	180,00



**Heizplatte durch Spiralfeder an Wasserbad gedrückt**  
Heating plate is pressed against the water bath by a spiral spring

**Mobile Chafing Dish Heizung**

heating element  
resistencia  
résistance



für alle marktgängigen Chafing Dishes  
suitable for all current popular chafing dishes, with special spring  
para todos los chafing dish más corrientes  
pour la plupart des chafing dish les plus courants

	Ø cm	↑ cm		€
12299	14	9 - 11	500 W / 220 V	42,00



**Rolltophaube „SWISS“**

rolltop-cover  
campana rolltop  
cloche rolltop



hochglanzpoliert, klappbar auf 90°, nachrüstbar für alle handelsüblichen Chafer

mirror polished finish, cover adjustable at 90°, usable for all commercial chafing dishes  
pulido brillante, tapa ajustable 90°, apto para todos los chafings profesionales  
poli brillant, ouverture réglable à 90°, apte pour tous les chafings professionnels

	cm	↑ cm	€
12310	55 x 34	19,5	94,00



**Bain-Marie Topf**

bain marie pot  
olla baño Maria  
marmite bain-marie



inkl. Deckel, mit Löffelaussparung

included cover, notched for spoon  
incluye tapa con hueco para la cuchara  
inclut le couvercle avec espace pour la louche

	Ø cm	↑ cm	ltr.	€
12244	20	18	4,5	29,00

Deckel / cover / tapa / couvercle

11244				9,00
-------	--	--	--	------



**Bain-Marie Deckel**

cover for bain marie  
tapa del baño maria  
couvercle du bain-marie



	cm	€
12243	54 x 33,5	28,00



**Wärme-Kies**

granite chips  
granulado térmico  
gravier thermique



für Chafing Dishes, feine Körnung, hohe Wärmespeicherung, kein Verkleben, ideal zum Warmhalten von Eiern

fine for chafing dishes and clean granite chippings, ideal for keeping eggs warm  
gravilla de granito fina limpia, ideal para mantener los huevos calientes  
gravier fin de granit, lavé, idéal pour maintenir les oeufs au chaud

	kg	€
81116	7	19,00



82274

Präsentationsmöglichkeit  
presentation example

# WARMERS



## Wärmelampe mit 2 Infrarotlampen

thermal bridge  
puente térmico  
pont thermique



höhenverstellbar 58 - 77,5 cm, inklusive 2 Lampen, Kabellänge: 1,5 Meter

height ajustable from 58 to 77,5 cm, including 2 infrared lamps, cable length: 1,5 metres

regulable en altura de 58 a 77,5 cm, con 2 lámparas de infrarrojos, longitud del cable: 1,5 metros

réglable en hauteur de 58 à 77,5 cm, avec 2 lampes infrarouges, longueur du câble: 1,5 mètre

	cm	↑ cm	V	W	Farbe / Colour	€
12265	50 x 35	58 - 77,5	230	2 x 250	■	145,00

## Ersatzbirne für Wärmelampe

infrared lamp / bulb  
lámpara infrarrojos / bombilla  
lampe infrarouge / ampoule

Fassung E27, Lichtfarbe: warmweiß

socket: E27, light colour: warm white

casquillo: E27, color de la luz: blanco cálido

douille: E27, couleur de lumière: blanc chaud

	W	fits to	€
12266	250	12265	10,00



## Speisenwärmer

warmer  
calienta platos  
chauffe-plat



3-flammig / 3 lights / 3 velas / 3 bougies

	cm	↑ cm	€
35065	34 x 18	6	18,70



## Speisenwärmer

warmer  
calienta platos  
chauffe-plat



2-flammig / 2 lights / 2 velas / 2 bougies

	cm	↑ cm	€
35343	34 x 13	6	14,20

# TWO IN ONE



Fondue

Feuerzange

13 tlg. Set  
13 pcs. set



2,2 ltr.

65060

65061

6 Stk.  
6 pcs.

65062

## Fondue und Feuerzangenbowle-Set „TWO IN ONE“

fondue and fire punch bowl set  
set para fondue o ponche caliente  
service à fondue et à punch

13-teiliges Set aus Edelstahl bestehend aus:

1 Topf, 1 Rechaud, 1 Spritzschutz, 1 Untersetzer, 1 Schöpfkelle, 1 Feuerzange,  
1 Pastenbrenner, 6 Fonduegabeln

13-piece stainless steel set consisting of:

1 pot, 1 rechaud, 1 splash guard, 1 coaster, 1 ladle, 1 fire tongs,  
1 paste burner, 6 fondue forks

set de 13 piezas de acero inoxidable compuesto por:

1 olla, 1 rechaud, 1 protector contra salpicaduras, 1 trébede, 1 cazo,  
1 pinza para el fuego, 1 quemador de pasta, 6 tenedores de fondue

set de 13 pièces en acier inox comprenant:

1 marmite, 1 rechaud, 1 pare-éclaboussures, 1 dessous de plat, 1 louche, 1 pince à feu,  
1 brûleur à pâte, 6 fourchettes à fondue

EDELSTAHL  
STAINLESS  
INOX  
18/8

PP  
POLYPROPYL

	Ø cm	↑ cm	ltr.	€ / set
65060	22	23	2,2	52,50

## Brennpastenbehälter zu 65060

fuel paste container for 65060  
recipiente para pasta de combustible para 65060  
récipient pour pâte à combustible pour 65060

EDELSTAHL  
STAINLESS  
INOX  
18/8

	cm	↑ cm	fits to	€
65061	26 x 12	10	65060	7,00

## Gabelset zu 65060

fork set for 65060  
set de tenedores para 65060  
set de fourchettes pour 65060

EDELSTAHL  
STAINLESS  
INOX

PP  
POLYPROPYL

	cm	→ cm	pcs.	fits to	€ / set
65062	24	Griff / handle 8	6	65060	8,00



# 5 STARS



Töpfe aus emailliertem Gusseisen leiten nicht nur die Wärme gut, sondern können sie auch lange energieschonend speichern – ideal für den professionellen Einsatz am Buffet!

Cooking pots made of enamelled cast iron not only conduct heat well, but can also store it for a long time while conserving energy - ideal for professional use at the buffet!

Las ollas de hierro fundido esmaltado no sólo conducen bien el calor, sino que también pueden almacenarlo durante mucho tiempo conservando la energía: ¡ideales para un uso profesional en el buffet!

Les marmites en fonte émaillée ne conduisent pas seulement bien la chaleur, mais peuvent aussi la conserver longtemps en économisant de l'énergie - idéal pour une utilisation professionnelle au buffet!



88300 2,5 ltr.



88301 2,5 ltr.



88312 2,5 ltr.

## Bräter mit Deckel „5 STARS“

roaster with lid  
cacerola con tapa  
cocotte avec couvercle



	Ø cm	↑ cm	ltr.	Farbe / Colour	€
88300	25	7 / 13	2,5		59,00
88301	25	7 / 13	2,5		59,00
88312	25	7 / 13	2,5		59,00



88300

inklusive Deckelhalter  
including lid holder



NEW



88302 4 ltr.



88303 4 ltr.



88313 4 ltr.

**Kochtopf mit Deckel „5 STARS“**  
 cooking pot with lid  
 olla con tapa  
 marmite avec couvercle



	Ø cm	↑ cm	ltr.	Farbe / Colour	€
88302	25	11,5 / 17,5	4		64,00
88303	25	11,5 / 17,5	4		64,00
88313	25	11,5 / 17,5	4		64,00



88302

inklusive Deckelhalter  
 including lid holder

NEW



88304 3 ltr.



88305 3 ltr.



88314 3 ltr.

**Bräter mit Deckel „5 STARS“**  
 roaster with lid  
 cacerola con tapa  
 cocotte avec couvercle



	Ø cm	↑ cm	ltr.	Farbe / Colour	€
88304	28	7 / 13,5	3		69,00
88305	28	7 / 13,5	3		69,00
88314	28	7 / 13,5	3		69,00



88304

inklusive Deckelhalter  
 including lid holder



**Kochtopf mit Deckel „5 STARS“**  
 cooking pot with lid  
 olla con tapa  
 marmite avec couvercle



	Ø cm	↑ cm	ltr.	Farbe / Colour	€
88306	28	13 / 20	6		74,00
88307	28	13 / 20	6		74,00
88315	28	13 / 20	6		74,00



inklusive Deckelhalter  
 including lid holder



**Bräter mit Deckel „5 STARS“**  
 roaster with lid  
 cacerola con tapa  
 cocotte avec couvercle



	cm	↑ cm	ltr.	Farbe / Colour	€
88308	33 x 25	11 / 17,5	5		79,00
88309	33 x 25	11 / 17,5	5		79,00
88316	33 x 25	11 / 17,5	5		79,00



inklusive Deckelhalter  
 including lid holder



**Auflaufform „5 STARS“**  
casserole dish  
fuente para gratinar  
plat à four



	cm	↑ cm	ltr.	Farbe / Colour	€
88310	33 x 24	6,5	3,5	Red	54,00
88311	33 x 24	6,5	3,5	Black	54,00
88317	33 x 24	6,5	3,5	Teal	54,00



**Deckelhalter, 2er Set**  
lid holder, 2 pcs.  
soporte para tapa, set de 2  
support de couvercle, set de 2



**mit Antirutschbeschichtung, für alle Töpfe mit Deckel einsetzbar, hitzebeständig**  
with non-slip coating, suitable for all pots with lids, heat-resistant  
revestimiento antideslizante, apto para todas las ollas con tapa, resistente al calor  
avec revêtement antidérapant, adapté à toutes les casseroles avec couvercle, résistant à la chaleur

	cm	↑ cm	Farbe / Colour	pcs.	€ / set
88320	10,5 x 8,5	3,5	Black	2	10,00



**NEW** SAMOWAR

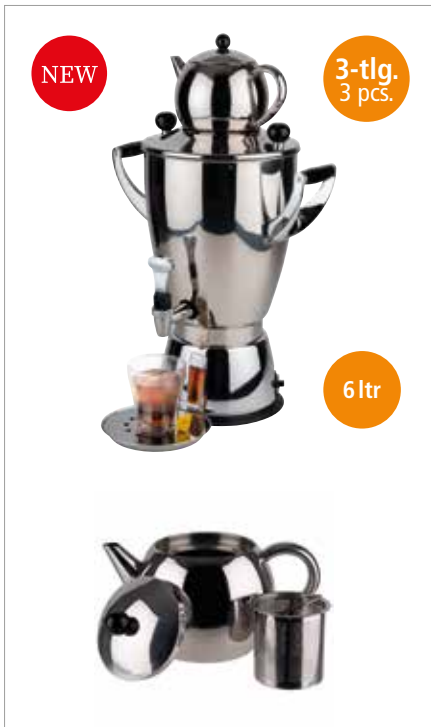

**NEW**

**3-tlg.  
3 pcs.**

**6 ltr**

**Samovar**  
samovar  
samovar  
samovar

**3-teiliges Set:**

- 1 Samovar, 230V, 50/60Hz, 1.800W (6 Liter)
- 1 Teekanne (1,1 Liter)
- 1 Tropfenschale

3 pcs. set:

- 1 samovar, 230V, 50/60Hz, 1.800W (6 ltr.)
- 1 teapot (1,1 ltr.)
- 1 drip tray

set de 3:

- 1 samovar, 230V, 50/60Hz, 1.800W (6 L.)
- 1 tetera (1,1 L.)
- 1 bandeja recogegotas

set de 3:

- 1 samovar, 230V, 50/60Hz, 1.800W (6 L.)
- 1 théière (1,1 L.)
- 1 bac ramasse-gouttes

	cm	↑ cm	ltr.	€
12315	35 x 21	58	6	540,00



**NEW**

**3-tlg.  
3 pcs.**

**12 ltr**

**Samovar**  
samovar  
samovar  
samovar

**3-teiliges Set:**

- 1 Samovar, 230V, 50/60Hz, 1.800W (12 Liter)
- 1 Teekanne (1,3 Liter)
- 1 Tropfenschale

3 pcs. set:

- 1 samovar, 230V, 50/60Hz, 1.800W (12 ltr.)
- 1 teapot (1,3 ltr.)
- 1 drip tray

set de 3:

- 1 samovar, 230V, 50/60Hz, 1.800W (12 L.)
- 1 tetera (1,3 L.)
- 1 bandeja recogegotas

set de 3:

- 1 samovar, 230V, 50/60Hz, 1.800W (12 L.)
- 1 théière (1,3 L.)
- 1 bac ramasse-gouttes

	cm	↑ cm	ltr.	€
12316	42 x 26	75	12	890,00





10,5 ltr.

**Kaffeedispenser „HAPPY HOUR“**

coffee dispenser  
dispensador de café  
distributeur de café



hochglanzpoliert, für warme Getränke, stabil und standfest, inkl. 1 Brennpastenbehälter  
mirror polished finish, for warm drinks, solid and stable, incl. 1 burner holder  
acabado pulido brillante para bebidas calientes, sólido y estable, incluye un calentador  
brillant, pour boissons chaudes, avec 1 brûleur, robuste et stable

	cm	↑ cm	ltr.	€
11672	31 x 33,5	54,5	10,5	210,00

Hahn / tap / grifo / robinet

	€
11671	27,00



**Elektro-Heizelement**

heating unit  
resistencia  
résistance



für Kaffeedispenser (Nr. 11672), 500 W, 220 V, einfach in das Gestell des Dispensers legen  
for coffee dispenser (no. 11672), 500 W, 220 V, insert into the frame of the dispenser  
para dispensador de café (11672), 500 W, 220V, directamente en el pie del dispensador  
pour distributeur à café (11672), 500 W, 220 V, directement dans le support

	€
12287	99,00



**Kaffeetasse „SNUG“**

coffee cup  
taza de café  
tasse à café



Porzellan, Griff: 2 cm / porcelain, handle: 2 cm / porcelana, asa: 2 cm / porcelaine, poignée: 2 cm

	Ø cm	↑ cm	ltr.	Farbe / Colour	VE / unit	€ / pc.
16003	9,5	6	0,2		6	4,10
16004	9,5	6	0,2		6	4,10
16005	9,5	6	0,2		6	4,10



**Kaffeuntertasse „SNUG“**

coffee saucer  
platillo de café  
soucoupe à café



Porzellan / porcelain / porcelana / porcelaine

	Ø cm	↑ cm	Farbe / Colour	VE / unit	€ / pc.
16012	14,5	2,5		6	3,40
16013	14,5	2,5		6	3,40
16014	14,5	2,5		6	3,40

# GN-CONTAINERS

## GN-Behälter Größen nach EN 631

Alle Behälter sind aus rostfreiem Chrom-Nickel-Edelstahl mit elektrolytisch polierter (seidenmatt) Oberfläche und somit perfekt geeignet für den professionellen Einsatz.

## GN-container according to EN 631

All pans are made of chrome/nickel stainless steel with a surface polished by electrolysis (satin-matt) and therefore highly suitable for professional operation.

## De conformidad con la norma europea EN 631.

Todos los contenedores están fabricados en acero inoxidable cromado/niquelado con su superficie (satinada) pulida por electrolisis lo que la hace altamente apropiado para el uso profesional.

## Bacs GN- Conforme à la norme EN 631

Tous les bacs sont fabriqués en inox/chrome/nickel, surface polie électrolythique (satiné). Approprié pour usage professionnel.

## Vorteile der rund geprägten U-Ecken:

- erhöhte Stabilität durch verstärktes Profil
- zielgerechtes und sauberes Ausgießen
- genaue Positionierung der GN-Behälter
- superleichtes Stapeln und Entstapeln
- kein Verklemmen der GN-Behälter
- hohe Stoßfestigkeit durch robuste Konstruktion
- ansprechendes Design und stilvoller Blickfang

## Advantages of the round-shaped U-Corners:

- increased stability due to the unique construction
- clean ladling and pouring
- exact positioning of the containers
- improved shock-resistance
- appealing design
- no seize of the containers

## Ventajas de las esquinas en U:

Perfil reforzado que confiere mayor rigidez y resistencia a la cubeta, diseño para verter fácil y limpiamente, fáciles de apilar y desapilar sin que se claven entre sí, construcción más robusta y resistente a los golpes mecánicos, diseño elegante.

## Avantages et fonctionnalité des angles en U:

Profil renforcé pour une meilleure consistance et rigidité du récipient, design qui facilite un versage propre et aisé, permet un empilage et désempilage faciles sans que les bacs restent coincés, meilleure résistance aux chocs mécaniques, seign élégant.

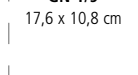
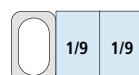
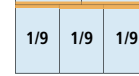
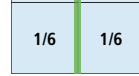
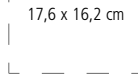
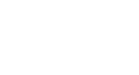
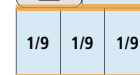
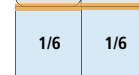
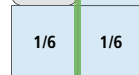
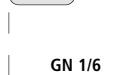
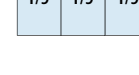
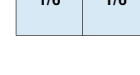
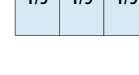
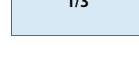
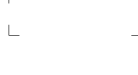
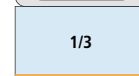
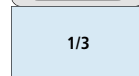
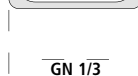
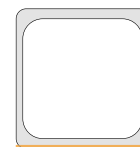
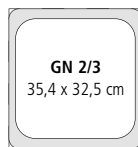
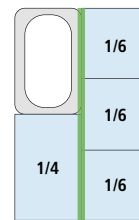
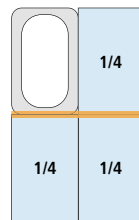
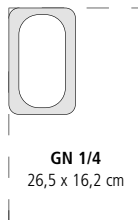
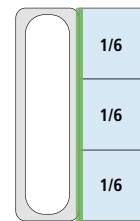
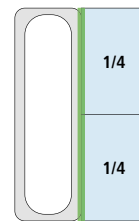
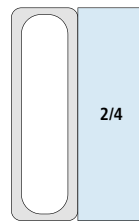
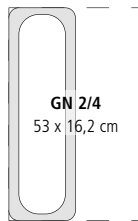
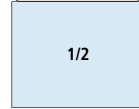
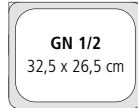
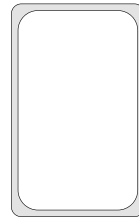



81102



81202



81301



81402



81604



81504



81702



81802

## GN-Behälter

GN-container

GN cubetas

GN bacs



	GN	↓ mm	ltr.	cm	€
81000	2/1	20	5,0	53,0 x 65,0	38,80
81095	1/1	10	1,25	53,0 x 32,5	13,90
81100	1/1	20	2,5	53,0 x 32,5	15,60
81101	1/1	40	5,0	53,0 x 32,5	17,50
81109	1/1	55	6,5	53,0 x 32,5	18,30
81102	1/1	65	9,0	53,0 x 32,5	18,60
81104	1/1	100	13,25	53,0 x 32,5	22,90
81106	1/1	150	20,0	53,0 x 32,5	34,50
81108	1/1	200	25,0	53,0 x 32,5	41,80

	GN	↓ mm	ltr.	cm	€
81200	1/2	20	1,0	32,5 x 26,5	6,40
81201	1/2	40	2,0	32,5 x 26,5	9,60
81209	1/2	55	2,8	32,5 x 26,5	9,90
81202	1/2	65	4,0	32,5 x 26,5	10,20
81204	1/2	100	6,0	32,5 x 26,5	13,80
81206	1/2	150	8,75	32,5 x 26,5	21,70
81208	1/2	200	11,65	32,5 x 26,5	28,00

	GN	↓ mm	ltr.	cm	€
81300	1/3	20	0,75	32,5 x 17,6	5,00
81301 <sup>NEW</sup>	1/3	40	1,5	32,5 x 17,6	6,20
81302	1/3	65	2,5	32,5 x 17,6	7,70
81304	1/3	100	4,0	32,5 x 17,6	10,90
81306	1/3	150	5,7	32,5 x 17,6	14,80
81308	1/3	200	7,0	32,5 x 17,6	19,60

	GN	↓ mm	ltr.	cm	€
81400	1/4	20	0,5	26,5 x 16,2	5,20
81401	1/4	40	1,0	26,5 x 16,2	5,90
81402	1/4	65	1,8	26,5 x 16,2	7,00
81404	1/4	100	2,8	26,5 x 16,2	9,30
81406	1/4	150	4,0	26,5 x 16,2	14,30
81408	1/4	200	5,5	26,5 x 16,2	17,80

	GN	↓ mm	ltr.	cm	€
81602	1/6	65	1,0	17,6 x 16,2	5,10
81604	1/6	100	1,6	17,6 x 16,2	7,00
81606	1/6	150	2,4	17,6 x 16,2	11,30
81608	1/6	200	3,0	17,6 x 16,2	13,90

	GN	↓ mm	ltr.	cm	€
81502	1/9	65	0,6	17,6 x 10,8	3,80
81504	1/9	100	1,0	17,6 x 10,8	5,70
81506	1/9	150	1,5	17,6 x 10,8	8,10

	GN	↓ mm	ltr.	cm	€
81700	2/3	20	1,5	35,4 x 32,5	11,20
81701	2/3	40	3,0	35,4 x 32,5	14,80
81702	2/3	65	5,5	35,4 x 32,5	17,10
81704	2/3	100	8,4	35,4 x 32,5	22,60
81706	2/3	150	12,5	35,4 x 32,5	32,60
81707	2/3	200	18,0	35,4 x 32,5	35,20

	GN	↓ mm	ltr.	cm	€
81800	2/4	20	1,2	53,0 x 16,2	9,40
81801	2/4	40	2,4	53,0 x 16,2	12,30
81802	2/4	65	3,6	53,0 x 16,2	14,40
81804	2/4	100	5,6	53,0 x 16,2	20,10
81806	2/4	150	8,7	53,0 x 16,2	23,40

## GN-CONTAINERS



### perforierte GN-Behälter perforated GN-container cubetas GN perforadas bacs GN perforés



	GN	↓ mm	cm	€
81911	1/1	40	53,0 x 32,5	18,30
81907	1/1	65	53,0 x 32,5	18,60
81908	1/1	100	53,0 x 32,5	22,90
81909	1/1	150	53,0 x 32,5	34,50
81910	1/1	200	53,0 x 32,5	41,80
81901	1/2	65	32,5 x 26,5	10,20
81902	1/2	100	32,5 x 26,5	13,80
81903	1/2	150	32,5 x 26,5	21,70
81904	1/2	200	32,5 x 26,5	28,00
81905	2/3	65	35,4 x 32,5	17,10
81906	2/3	100	35,4 x 32,5	22,60



### GN 1/6 Abklopfbehälter

GN 1/6 tapping container  
GN 1/6 contenedor knock-out  
GN 1/6 bac knock-out



mit Abklopfstange aus Silikon, rutschfester Boden

with silicone tapping rod, non-slip bottom  
con varilla de silicona, base antideslizante  
avec tige en silicone, fond antidérapant

	cm	↑ cm	ltr.	€
81611	17,6 x 16,2	15	2,4	19,00



rutschfester Boden  
non-slip bottom



### GN-Behälter Set, 4 teilig

GN-container, 4 pcs.  
GN cubetas, set de 4  
GN bacs, set de 4



bestehend aus: Edelstahlbehälter 1x GN 1/2 + 2x GN 1/4 + 1 Adapter

consisting of: stainless steel containers 1x GN 1/2 + 2x GN 1/4 + adapter  
consiste en: cubetas de acero inoxidable 1x GN 1/2 + 2x GN 1/4 + adaptador  
composé de: bacs en acier inox 1x GN 1/2 + 2x GN 1/4 + adaptateur

	GN	↓ mm	ltr.	cm	pcs	€ / set
81850	1/2	65	4	32,5 x 26,5	1	26,60
	1/4	65	1,8	26,40 x 16,2	2	
	Adapter			31,5	1	

Lieferung in Farbverpackung  
delivery in colour packaging



**GN-Deckel**

GN-lid  
GN tapa  
GN couvercle

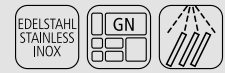
**ohne Löffelaussparung**

without notched edge for spoons  
sin agujero para cucharón  
sans espace pour louche

	GN	cm	€
81195	1/1	53,0 x 32,5	14,40
81295	1/2	32,5 x 26,5	7,40
81395	1/3	32,5 x 17,6	5,60
81495	1/4	26,5 x 16,2	5,20
81695	1/6	17,6 x 16,2	3,10
81591	1/9	17,6 x 10,8	3,20
81795	2/3	35,4 x 32,5	15,80
81895	2/4	53,0 x 16,2	11,40

**GN-Deckel**

GN-lid  
GN tapa  
GN couvercle

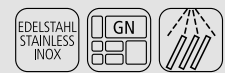
**mit Löffelaussparung**

with notched edge for spoons  
con agujero para cucharón  
avec espace pour louche

	GN	cm	€
81191	1/1	53,0 x 32,5	15,60
81292	1/2	32,5 x 26,5	8,20
81391	1/3	32,5 x 17,6	6,30
81492	1/4	26,5 x 16,2	5,90
81692	1/6	17,6 x 16,2	3,50
81595	1/9	17,6 x 10,8	3,30
81791	2/3	35,4 x 32,5	17,10
81891	2/4	53,0 x 16,2	12,70



Die Löffelaussparung mit Prägung verhindert das Zurückfließen von Flüssigkeit auf dem Deckel in den Behälter.

The notch for spoon with embossing prevents liquid on the lid from flowing back into the container.

## GN-CONTAINERS



### GN Transport-Steck-Deckel

GN-lid with silicone seal  
GN tapa hermética con junta  
GN couvercle hermétique avec joint



**Silikondichtung, Griffmulde und Loch gegen Unterdruck, schwappsicherer Transport nicht für Kombidämpfer geeignet**

silicone joint, flat handle, vent to compensate, slosh-proof transport, for pressure, not usable for steam oven  
junta de silicona, asa empotrada, válvula para compensar, transporte sin salpicaduras, la presión, no se puede utilizar en hornos de vapor  
joint silicone, anse encastrée, valve pour compenser la pression, transport sans éclaboussures, ne convient pas pour les étuves combinées

	GN	cm	€
80023	1/1	53,0 x 32,5	38,60
80024	1/2	32,5 x 26,5	24,00
80025	1/3	32,5 x 17,6	21,00
80026	1/4	26,5 x 16,2	18,00
80027	1/6	17,6 x 16,2	14,80
80028	2/4	53,0 x 16,2	34,80
80029	2/3	35,4 x 32,5	37,40



### Adapter / Zwischensteg

adapter  
adaptador  
adaptateur



**ermöglicht stabilen Halt von GN-Behältern im CD, rostfreier Chrom-Nickel-Edelstahl**

for fixing GN pans, chrome / nickel stainless steel  
para sujetar las cubetas GN, acero inox  
support stable pour les bacs GN

	cm	€
81996	15,9 längs bei GN 1/4 / lengthwise GN 1/4 longitud GN 1/4 / GN 1/4 dans la longueur	1,80
81997	17,6 längs bei GN 1/9 / lengthwise GN 1/9 longitud GN 1/9 / GN 1/9 dans la longueur	2,00
81999	32,5 quer bei GN 1/2 / crosswise GN 1/2 de ancho GN 1/2 / GN 1/2 dans la largeur	3,20
81998	52,5 längs bei GN 1/1 / lengthwise GN 1/1 longitud GN 1/1 / GN 1/1 dans la longueur	5,50



### GN Abtropfgitter

GN-drainer  
GN escurridor  
GN égouttoir



**Abtropfgitter aus Edelstahl für Gastronorm Behälter, passend für GN 1/1 und GN 1/2**

stainless steel GN drainer for GN 1/1 + GN 1/2  
escurridor GN de acero inoxidable para GN 1/1 + GN 1/2  
égouttoir GN en acier inoxydable pour GN 1/1 + GN 1/2

	GN	cm	↑ cm	€
81117	1/1	45 x 25	1,5	22,00
81118	1/2	25 x 19	1,5	16,00



**GN-Behälter aus Polypropylen**

GN-container polypropylene  
GN cubetas polipropileno  
GN bacs polypropilène



**transparent: Skalierung in Liter, robust und formstabil**

transparent: liter scale, solid quality

transparente: graduación en litros, alta calidad

transparent: graduation en litres, haute-qualité

	GN	↓ mm	ltr.	cm	€
82104	1/1	65	8,5	53 x 32,5	10,20
82106	1/1	100	13,0	53 x 32,5	11,70
82108	1/1	150	19,5	53 x 32,5	13,30
82110	1/1	200	26,0	53 x 32,5	16,30
	GN	↓ mm	ltr.	cm	€
82112	1/2	65	3,9	32,5 x 26,5	5,50
82114	1/2	100	5,9	32,5 x 26,5	6,30
82116	1/2	150	8,9	32,5 x 26,5	7,80
82117	1/2	200	11,8	32,5 x 26,5	9,00
	GN	↓ mm	ltr.	cm	€
82118	1/3	65	2,4	32,5 x 17,5	4,60
82120	1/3	100	3,6	32,5 x 17,5	5,30
82122	1/3	150	5,3	32,5 x 17,6	6,90
82123	1/3	200	7,0	32,5 x 17,6	7,90
	GN	↓ mm	ltr.	cm	€
82128	1/4	65	1,7	26,5 x 16,2	3,80
82130	1/4	100	2,5	26,5 x 16,2	4,40
82132	1/4	150	3,7	26,5 x 16,2	5,80
82134	1/4	200	4,8	26,5 x 16,2	9,20
	GN	↓ mm	ltr.	cm	€
82136	1/6	65	1,0	17,6 x 16,2	3,20
82138	1/6	100	1,5	17,6 x 16,2	3,70
82140	1/6	150	2,2	17,6 x 16,2	4,30
82142	1/6	200	2,8	17,6 x 16,2	7,80
	GN	↓ mm	ltr.	cm	€
82150	1/9	65	0,6	17,6 x 10,8	3,00
82151	1/9	100	1,0	17,6 x 10,8	3,20



**stapelbar**  
stackable



**Skalierung**  
scaling



**GN-Deckel**

GN-lid  
GN tapa  
GN couvercle



	GN	↑ cm	cm	€
82101	1/1	1,5	53,0 x 32,5	5,70
82113	1/2	1,5	32,5 x 26,5	3,40
82119	1/3	1,5	32,5 x 17,6	2,90
82129	1/4	1,5	26,5 x 16,2	2,80
82137	1/6	1,5	17,6 x 16,2	2,70
82159	1/9	1,5	17,6 x 10,8	2,60

# BLACK GN CONTAINERS



82065 GN 1/2 | 100 mm



82069 GN 1/3 | 100 mm



82073 GN 1/4 | 100 mm



82077 GN 1/6 | 100 mm



82081 GN 1/9 | 100 mm

## GN-Behälter aus Polycarbonat

GN-container polycarbonate

GN cubeta policarbonato

GN bac polycarbonate

schwarz: Skalierung in Liter, robust und formstabil

black: liter scale, solid quality

negro: graduación en litros, alta calidad

noir : graduation en litres, haute-qualité



	GN	↓ mm	ltr.	cm	€
82064	1/2	65	3,9	32,5 x 26,5	9,00
82065	1/2	100	5,9	32,5 x 26,5	11,00
82066	1/2	150	8,9	32,5 x 26,5	13,50
82068	1/3	65	2,4	32,5 x 17,6	7,60
82069	1/3	100	3,6	32,5 x 17,6	9,00
82070	1/3	150	5,3	32,5 x 17,6	11,00
82072	1/4	65	1,7	26,5 x 16,2	5,90
82073	1/4	100	2,5	26,5 x 16,2	7,00
82074	1/4	150	3,7	26,5 x 16,2	8,30
82076	1/6	65	1,0	17,6 x 16,2	5,10
82077	1/6	100	1,5	17,6 x 16,2	5,50
82078	1/6	150	2,2	17,6 x 16,2	6,70
82081	1/9	100	1,0	17,6 x 10,8	4,30



passende Deckel, S. 421  
suitable lid, page 421



stapelbar  
stackable



## GN-Behälter aus Polycarbonat

GN-container polycarbonate

GN cubeta polycarbonato

GN bac polycarbonate



	GN	↓ mm	ltr.	cm	€
82004	1/1	65	8,5	53 x 32,5	17,50
82006	1/1	100	13,0	53 x 32,5	20,00
82008	1/1	150	19,5	53 x 32,5	25,40
82010	1/1	200	26,0	53 x 32,5	33,20
	GN	↓ mm	ltr.	cm	€
82012	1/2	65	3,9	32,5 x 26,5	8,60
82014	1/2	100	5,9	32,5 x 26,5	10,40
82016	1/2	150	8,9	32,5 x 26,5	12,80
82017	1/2	200	11,8	32,5 x 26,5	17,10
	GN	↓ mm	ltr.	cm	€
82018	1/3	65	2,4	32,5 x 17,6	7,20
82020	1/3	100	3,6	32,5 x 17,6	8,60
82022	1/3	150	5,3	32,5 x 17,6	10,40
82023	1/3	200	7,0	32,5 x 17,6	12,80
	GN	↓ mm	ltr.	cm	€
82028	1/4	65	1,7	26,5 x 16,2	5,60
82030	1/4	100	2,5	26,5 x 16,2	6,70
82032	1/4	150	3,7	26,5 x 16,2	10,60
82034	1/4	200	4,8	26,5 x 16,2	13,10
	GN	↓ mm	ltr.	cm	€
82036	1/6	65	1,0	17,6 x 16,2	4,90
82038	1/6	100	1,5	17,6 x 16,2	5,20
82040	1/6	150	2,2	17,6 x 16,2	6,30
82042	1/6	200	2,8	17,6 x 16,2	9,00
	GN	↓ mm	ltr.	cm	€
82050	1/9	65	0,6	17,6 x 10,8	3,50
82051	1/9	100	1,0	17,6 x 10,8	4,00



## GN-Deckel

GN-lid

GN tapa

GN couvercle



	GN	↑ cm	cm	€
82001	1/1	2,5	53,0 x 32,5	11,60
82013	1/2	2,5	32,5 x 26,5	6,70
82019	1/3	2,5	32,5 x 17,6	5,30
82029	1/4	2,5	26,5 x 16,2	4,30
82037	1/6	2,5	17,6 x 16,2	3,30
82059	1/9	2,5	17,6 x 10,8	3,00



## GN Abtropfgitter

GN drainer

GN escurridor

GN égouttoir



	für GN	↑ cm	cm	€
82003	1/1	2	47,3 x 26,8	8,80
82005	1/2	2	26,8 x 20,8	4,90
82007	1/3	2	26,8 x 11,8	3,80
82009	1/4	2	20,6 x 10,8	3,00
82011	1/6	2	11,7 x 10,4	2,60



# PORCELAIN GN CONTAINERS

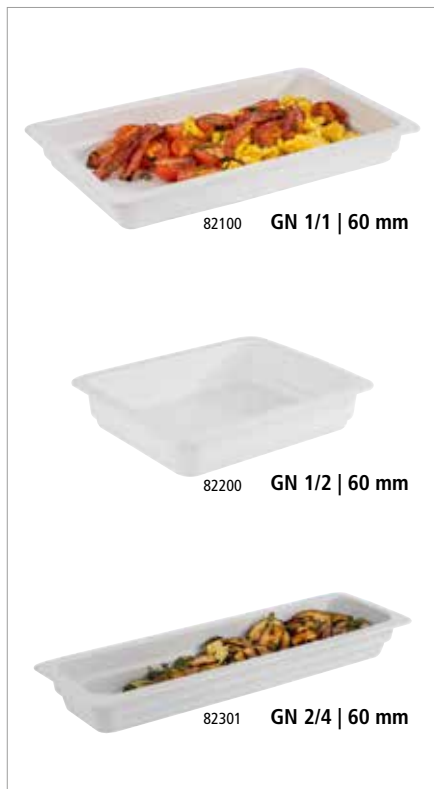

**GN-Behälter**  
GN-container  
GN cubetas  
GN bac

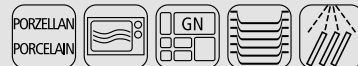

	GN	↓ mm	ltr.	cm	€
82100	1/1	60	7,1	53,0 x 32,5	69,00
82200	1/2	60	3,4	32,5 x 26,5	31,00
82300	1/3	60	2,0	32,5 x 17,6	25,60
82306	2/3	60	4,6	35,4 x 32,5	46,00
82301	2/4	60	3,0	53,0 x 16,2	43,00

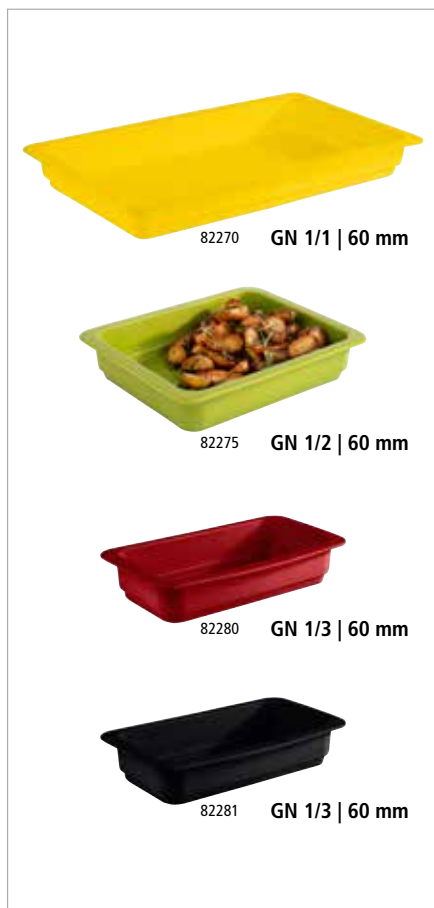

**GN-Behälter**  
GN-container  
GN cubeta  
GN bac

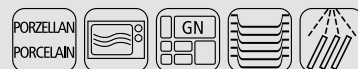

	GN	↓ mm	ltr.	cm	Farbe / colour	€
82270	1/1	60	7,1	53,0 x 32,5		73,00
82271	1/1	60	7,1	53,0 x 32,5		73,00
82272	1/1	60	7,1	53,0 x 32,5		73,00
82273	1/1	60	7,1	53,0 x 32,5		73,00
82274	1/2	60	3,4	32,5 x 26,5		39,00
82275	1/2	60	3,4	32,5 x 26,5		39,00
82276	1/2	60	3,4	32,5 x 26,5		39,00
82277	1/2	60	3,4	32,5 x 26,5		39,00
82278	1/3	60	2,0	32,5 x 17,6		31,00
82279	1/3	60	2,0	32,5 x 17,6		31,00
82280	1/3	60	2,0	32,5 x 17,6		31,00
82281	1/3	60	2,0	32,5 x 17,6		31,00



Präsentationsmöglichkeit  
presentation example



**Backblech**  
baking sheet  
bandeja pastelera  
plaque à pâtisserie



gelocht Ø 3 mm, Materialstärke 1,5 mm, Silikon beschichtet, temperaturbeständig bis 240°C  
perforated Ø 3 mm, coated with silicon, heat resistant up to 240°C  
aluminio con revestimiento de silicona perforada, resistente hasta 240°  
aluminium avec revêtement silicone, perforée, température maxi 240°

	GN	cm	€
88285	1/1	53 x 32,5	38,00

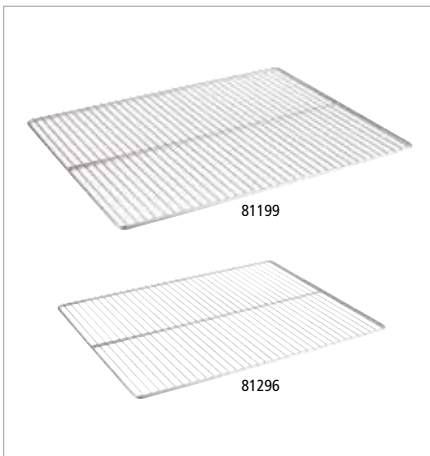

**GN Roste**  
GN grid  
GN rejilla  
GN grille



elektrolytisch poliert, Drahtstärke 3 mm, Rahmendraht 6 mm, extra schwere Qualität  
electro-polished, wire thickness 3 mm, frame wire 6 mm, extra heavy quality  
inox pulido electrolítico, grosor alambre 3 mm, grosor marco 6 mm, calidad reforzada  
inox poli électrolytique, fil 3 mm, cadre 6 mm, qualité renforcée

	GN	cm	€
81199	2/1	65,0 x 53,0	43,00
81198	1/1	53,0 x 32,5	20,40
81796	2/3	32,5 x 35,4	13,80
81296	1/2	32,5 x 26,5	11,20



**GN 1/3 Bestecksammler**  
GN 1/3 container  
GN 1/3 cubeta  
GN 1/3 bac



mit 2 Haken zum Einhängen an Servier- oder Transportwagen  
container with 2 hooks, to hang on trolleys for cutlery  
cubeta con 2 ganchos para cubiertos, a colgar del carro  
bac à couverts avec 2 crochets, à accrocher au chariot

	GN	↓ mm	cm	€
11978	1/3	150	32,5 x 17,5	23,00



**GN Tablett „FRAMES“**  
GN tray  
GN bandeja  
GN plateau

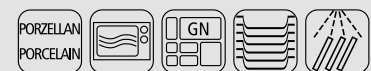

	GN	↑ cm	cm	€
82355	1/1	2	53,0 x 32,5	46,00
82356	1/2	2	32,5 x 26,5	26,00
82357	1/3	2	32,5 x 17,6	22,00



# GN-CONTAINERS



## GN-Behälter „ECOLINE“

GN container

GN cubeta

GN bac

mit Stapelnocke

with notching edge

con borde marcado para el apilado

avec rebord pour l'empilage



	GN	↓ mm	ltr.	cm	Farbe / Colour	€
83759	1/1	65	7,10	53,0 x 32,5		32,60
83755	2/4	65	3,00	53,0 x 16,2		22,00
83757	1/2	65	3,40	32,5 x 26,5		18,60
83753	1/3	65	2,00	32,5 x 17,6		16,00
83751	1/4	65	1,35	26,5 x 16,2		14,20
83749	1/6	65	0,80	17,6 x 16,2		11,20

	GN	↓ mm	ltr.	cm	Farbe / Colour	€
83758	1/1	65	7,10	53,0 x 32,5		32,60
83754	2/4	65	3,00	53,0 x 16,2		22,00
83756	1/2	65	3,40	32,5 x 26,5		18,60
83752	1/3	65	2,00	32,5 x 17,6		16,00
83750	1/4	65	1,35	26,5 x 16,2		14,20
83748	1/6	65	0,80	17,6 x 16,2		11,20

	GN	↓ mm	ltr.	cm	Farbe / Colour	€
84300	1/1	100	10,6	53,0 x 32,5		38,00
84302	2/4	100	4,3	53,0 x 16,2		27,40
84301	1/2	100	4,7	32,5 x 26,5		22,60
84303	1/3	100	2,7	32,5 x 17,6		18,40
84304	1/4	100	1,9	26,5 x 16,2		16,00
84305	1/6	100	1,0	17,6 x 16,2		12,20

	GN	↓ mm	ltr.	cm	Farbe / Colour	€
84306	1/1	100	10,6	53,0 x 32,5		38,00
84308	2/4	100	4,3	53,0 x 16,2		27,40
84307	1/2	100	4,7	32,5 x 26,5		22,60
84309	1/3	100	2,7	32,5 x 17,6		18,40
84310	1/4	100	1,9	26,5 x 16,2		16,00
84311	1/6	100	1,0	17,6 x 16,2		12,20

## GN-Deckel

GN-lid

GN tapa

GN couvercle



	GN	cm	€
82001	1/1	53,0 x 32,5	11,60
82013	1/2	32,5 x 26,5	6,70
82019	1/3	32,5 x 17,6	5,30
82029	1/4	26,5 x 16,2	4,30
82037	1/6	17,6 x 16,2	3,30



NEW



79030 GN 1/1



79033 GN 1/2



79034 GN 1/3

GN Behälter „FRIENDLY“

GN pan  
GN cubeta  
GN bac



friendly

	cm	↑ cm	ltr.	Farbe / Colour	GN	€
79030	53 x 32,5	6,5	7,1		1/1	24,00
79031	53 x 32,5	6,5	7,1		1/1	24,00
79032	32,5 x 26,5	6,5	3,4		1/2	14,90
79033	32,5 x 26,5	6,5	3,4		1/2	14,90
79034	32,5 x 17,6	6,5	2		1/3	12,80
79035	32,5 x 17,6	6,5	2		1/3	12,80
79036	32,5 x 17,6	10	2,7		1/3	14,90
79037	32,5 x 17,6	10	2,7		1/3	14,90

GN Tablett „FRIENDLY“

GN tray  
GN bandeja  
GN plateau



friendly

	cm	↑ cm	Farbe / Colour	GN	€
79006	32,5 x 26,5	3,0		1/2	15,80
79007	32,5 x 26,5	3,0		1/2	15,80



79006 GN 1/2



79007 GN 1/2

## SERVING TROLLEYS



### Servier- / Transportwagen

service trolley  
carro de servicio  
chariot de service



**mit 3 Borden, Bordmaße 83 x 51 cm, Abstand zwischen den Borden 26 cm, Tragfähigkeit 120 kg, 4 Lenkrollen, davon 2 feststellbar, Lieferung demontiert, einfache Montage**

with 3 trays, trays 83 x 51 cm, size between the trays 26 cm, total load capacity 120 kg, 4 wheels with 2 brakes, unassembled, simple assembly  
con 3 bandejas inox mate, 83 x 51 cm, la medida entre bandejas 26 cm, capacidad total 120 kg, 4 ruedas con 2 frenos, construcción robusta, montaje fácil  
3 niveaux, 83x51 cm chacun, distance entre niveaux 26 cm, capacité maxi 120 kg au total, 4 roues dont 2 avec frein, construction robuste, montage facile

	cm	↑ cm	€
11979	91 x 59	93	165,00



### Servier- / Transportwagen

service trolley  
carro de servicio  
chariot de service



**mit 2 Borden, Bordmaße 83 x 51 cm, Abstand zwischen den Borden 56 cm, Tragfähigkeit 80 kg, 4 Lenkrollen, davon 2 feststellbar, Lieferung demontiert, einfache Montage**

with 2 trays, trays 83 x 51 cm, size between the trays 56 cm, total load capacity 80 kg, 4 wheels with 2 brakes, unassembled, simple assembly  
con 2 bandejas de acero inoxidable mate, 83 x 51 cm, la medida entre bandejas 56 cm, capacidad total 80 kg, 4 ruedas, con 2 frenos, construcción robusta, montaje fácil  
2 niveaux, 83 x 51 cm chacun, distance entre niveaux 56 cm, capacité maxi 80 kg au total, 4 roues dont 2 avec frein, construction robuste, montage facile

	cm	↑ cm	€
11977	91 x 59	93	146,00

**Servier- / Transportwagen**

serving trolley  
carro de servicio  
chariot de service



Aluminiumrahmen, 3 Böden, Abstand zwischen den Böden 31 cm, mit 4 Lenkrollen, alle mit Feststellern, Tragfähigkeit: 50 kg je Boden, 150 kg insgesamt, demontiert, einfache Montage, Lieferung ohne Container und Dekoration

frame aluminium, 3 shelves, distance between shelves 31 cm, 4 swivel wheels, all equipped with brakes, max. load per shelf 50 kg, 150 kg total, demounted, easy to mount, delivery without containers and decoration

marco aluminio, 3 pisos, distancia entre cada piso 31 cm, 4 ruedas giratorias, las 4 con frenos, carga máxima por bandeja 50 kg, 150 kg en total, se sirve desmontado, fácil de montar (se entrega sin contenedores ni decoración)

chassis aluminium, 3 étages, distance entre niveaux 31 cm, 4 roues pivotantes, toutes avec frein, charge maximum 50 kg par niveau, 150 kg au total, livré démonté, montage facile (livré sans récipients ni décoration)

	cm	↑ cm		€
11945	108 x 50	96	without containers	150,00

**Container zum Einhängen, passend zum Servier- / Transportwagen 11945**

container to hang up, suitable serving trolley 11945  
contenedor para colgar, adaptado para el carro ref. 11945  
récipient à suspendre, pour chariot de service 11945



	cm	↑ cm	ltr.	€
11946	33 x 23	56,5	42	35,00
11947	33 x 23	17,5	13	18,00

**GN 1/1 Regalwagen**

GN 1/1 trolley  
GN 1/1 carro  
GN 1/1 chariot



mit 15 Doppelauflegeschieben, zum Transport von bis zu 30 GN-Tablets GN 1/2 oder 15 GN-Behältern bis GN 1/1 (Längseinschub), bei einem Stapelabstand von 75 mm, mit 4 Lenkrollen, 2 mit Feststellern, Tragfähigkeit 100 kg

15 double bars, for transporting up to 30 trays GN 1/2 or 15 GN containers up to GN 1/1 (lengthwise insertion), size between the trays 75 mm, with 4 swivel wheels, 2 with brakes, max. load 100 kg

15 raíles de soporte dobles, para transportar hasta 30 bandejas GN 1/2 o 15 cubetas GN hasta GN 1/1 (inserción longitudinal), distancia entre las bandejas de 75 mm, con 4 ruedas giratorias, 2 con freno, carga máxima de 100 kg

15 doubles rails de support, pour transporter jusqu'à 30 plateaux GN 1/2 ou 15 bacs GN jusqu'à GN 1/1 (insertion longitudinale), distance entre les plateaux 75 mm, avec 4 roues pivotantes, 2 avec frein, capacité de charge 100 kg

	cm	↑ cm		€
71441	55 x 38,5	173,5		268,00



mit beidseitiger Kipp- und Durchschubsicherung  
with tilt and push-through protection on both sides

## CUTLERY BOXES



### Besteckbehälter

cutlery box  
recipiente para cubiertos  
réceptif pour couverts

**Akazienholz, 4 Fächer (26 x 11,5 cm)**

acacia wood, 4 compartments (26 x 11,5 cm)  
madera de acacia, 4 compartimentos (26 x 11,5 cm)  
bois d'acacia, 4 compartiments (26 x 11,5 cm)



	cm	↑ cm	Farbe / Colour		€
11952	51 x 28	13		nature	50,00
11951	51 x 28	13		vintage white	50,00



### Besteckbehälter mit Deckel

cutlery box with cover  
caja de cubiertos con tapa  
range-couverts avec couvercle

**Akazienholz, 4 Fächer (26 x 11,5 cm), mit Deckel**

acacia wood, 4 compartments (26 x 11,5 cm), with cover  
madera de acacia, 4 compartimentos (26 x 11,5 cm), con tapa  
bois d'acacia, 4 compartiments (26 x 11,5 cm), avec couvercle



	cm	↑ cm	Farbe / Colour		€
11949	51 x 28	14,5		nature	74,00
11948	51 x 28	14,5		vintage white	74,00



### GN 1/1 Besteckbehälter

GN 1/1 dispenser GN  
GN 1/1 dispensador de cubiertos  
GN 1/1 bac à couverts

**in Handarbeit geflochten, 4 Mulden, Kunststoff-Geflecht, Drahtgestell, braun-schwarz**

hand-woven, 4 troughs, plastic wickerwork, wire frame, brown-black  
cesta trensada a mano, 4 compartimentos, mimbre de plástico, marco de alambre, marrón-negro  
corbeille tressée à main, 4 compartiments, plastique tressé, armature en fil métallique, brun-noir



	cm	↑ cm	Farbe / Colour		GN	€
11966	53 x 32,5	9			1/1	41,00



### GN 1/1 Besteckbehälter

GN 1/1 cutlery dispenser  
GN 1/1 dispensador de cubiertos  
GN 1/1 bac à couverts

**4 Mulden, Kunststoff-Geflecht, Drahtgestell, beige**

4 troughs, plastic wickerwork, wire frame, beige  
4 compartimentos, mimbre de plástico, marco de alambre, beige  
4 compartiments, plastique tressé, structure métallique, beige



	cm	↑ cm	Farbe / Colour		GN	€
11965	53 x 32,5	10			1/1	27,40



**GN 1/1 Besteckbehälter**

GN 1/1 cutlery bin  
GN 1/1 recipiente para cubiertos  
GN 1/1 récipients pour couverts



**4 Mulden**

4 troughs  
4 compartimentos  
4 compartments

	cm	↑ cm	Farbe / Colour	GN	€
11954	53 x 32,5	10	■	1/1	7,50
11955	53 x 32,5	10	■	1/1	7,50

**3 Mulden, 3 Köcher**

3 troughs, 3 cutlery baskets  
3 compartimentos, 3 cestas para cubiertos  
3 compartments, 3 corbeilles à couverts

	cm	↑ cm	Farbe / Colour	GN	€
11960	53 x 32,5	10	■	1/1	7,50



**Besteckbehälter**

cutlery basket  
recipiente para cubiertos  
récipients pour couverts



**4 Löcher inklusive 4 Edelstahl Köcher**

4 holes including 4 stainless baskets  
4 agujeros con 4 cestas de acero inoxidable  
4 trous avec 4 corbeilles en acier inox

	cm	↑ cm	Farbe / Colour	€
93321	27 x 27	15	■	79,00



**Besteckköcher**

cutlery basket  
cesta para cubiertos  
corbeille à couverts



Polyethylen weiß / polyethylene white plastic / polietileno blanco / polyéthylène blanc

	Ø cm	↑ cm	€
11998	9,5	13,5	2,90

Edelstahl matt poliert / stainless steel matt polished / acero inoxidable pulido mate / acier inox poli mat

	Ø cm	↑ cm	€
11999	9,5	13,5	8,00



**Besteckkasten „INDUSTRIAL“**

cutlery box  
caja para cubiertos  
boîte pour couverts



**schwarz, mit Beschriftungsfach 6,5 x 2,5 cm**

black, with labelling compartment 6,5 x 2,5 cm  
negro, con compartimento de etiquetado 6,5 x 2,5 cm  
noir, avec compartiment pour l'étiquetage 6,5 x 2,5 cm

	cm	↑ cm	litr.	€
40676	23,0 x 15,5	13,0	2,4	15,20

# CUTLERY BOXES

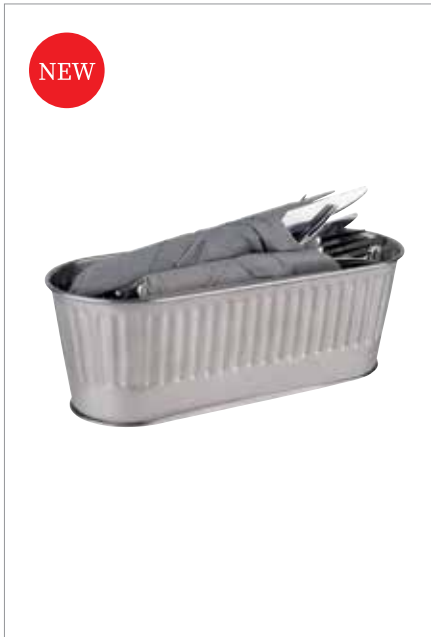

## Besteckbehälter / Korb

cutlery bin / basket  
 porta cubiertos / cesta  
 range-couverts / corbeille  
**matt poliert, Boden: 29 x 8,5 cm**  
 matt polished, base: 29 x 8,5 cm  
 pulido mate, base: 29 x 8,5 cm  
 poli mat, fond: 29 x 8,5 cm



	cm	↑ cm	ltr.	Farbe / Colour	€
11752	29,5 x 12	10	2		11,50



Präsentationsmöglichkeit  
 presentation example



## Besteckbehälter / Korb

cutlery bin / basket  
 porta cubiertos / cesta  
 range-couverts / corbeille  
**Boden: 29 x 8,5 cm**  
 base: 29 x 8,5 cm  
 base: 29 x 8,5 cm  
 fond: 29 x 8,5 cm



	cm	↑ cm	ltr.	Farbe / Colour	€
11753	29,5 x 12	10	2		13,00



Präsentationsmöglichkeit  
 presentation example

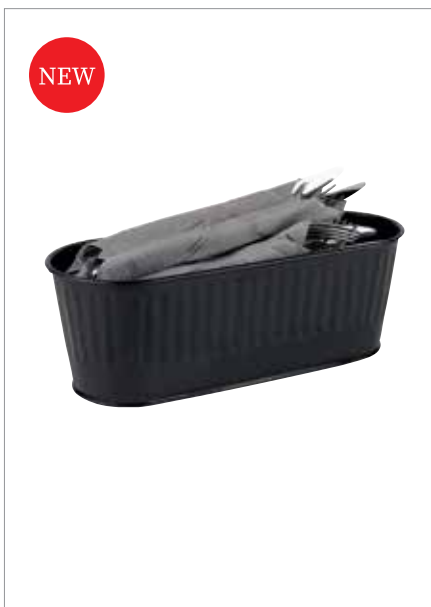

## Besteckbehälter / Korb

cutlery bin / basket  
 porta cubiertos / cesta  
 range-couverts / corbeille  
**Boden: 29 x 8,5 cm**  
 base: 29 x 8,5 cm  
 base: 29 x 8,5 cm  
 fond: 29 x 8,5 cm



	cm	↑ cm	ltr.	Farbe / Colour	€
11754	29,5 x 12	10	2		13,00



Präsentationsmöglichkeit  
 presentation example

**NEW**



inklusive 2 Schalen  
included 2 bowls

**Löffelablage mit 2 Schalen**

spoon rest with 2 bowls  
reposa cucharas con 2 cuencos  
repose-cuillère avec 2 bols

inklusive 2 Schalen, Ø 12 cm, H: 5,5 cm, 250 ml, ohne Löffel

with 2 bowls Ø 12 cm, h: 5,5 cm, 250 ml, without a spoon  
con 2 cuencos Ø 12 cm, h: 5,5 cm, 250 ml, sin cuchara  
avec 2 bols Ø 12 cm, h: 5,5 cm, 250 ml, sans cuillère



	cm	↑ cm	Farbe / Colour	€
00651	23,5 x 12,5	19	■	19,00



**Besteckablage**

cutlery rest  
reposa cuchara  
pose-cuillère



	cm	↑ cm	€
00650	27 x 11	3,5	8,60



**Besteckablage „SMALL WAVE“**

cutlery rest  
reposa cuchara  
pose-cuillère



	cm	↑ cm	€
83897	26 x 13	4,5	10,90



**Besteckablage „BOWL“**

cutlery rest  
reposa cuchara  
pose-cuillère



	cm	↑ cm	litr.	€
83803	22,5 x 11	6	0,5	7,80



**Besteckablage „SPOON“**

cutlery rest  
reposa cuchara  
pose-cuillère



	cm	↑ cm	€
83801	26 x 10,5	5	7,40



**Teig- und Pizzaballenbehälter**  
dough and pizza ball container  
recipiente para masa y bolas de pizza  
réceptier à pâte et boules à pizza



**Innenmaß 56,5 x 36,5 cm, H: 6,5 cm**  
inner dimension 56,5 x 36,5 cm, H: 6,5 cm  
medida interior 56,5 x 36,5 cm, H: 6,5 cm  
dimension intérieure 56,5 x 36,5 cm, H: 6,5 cm

	cm	↑ cm	ltr.	€
82440	60 x 40	7	13	12,00



**stapelbar**  
stackable

passender Deckel / fitting lid / tapa adecuada / couvercle approprié

	cm	↑ cm		€
82441	60 x 40	1		10,00



**Eier-Box**  
eggs box  
caja para huevos  
boîte à oeufs



**mit luftdichtem Deckel, für 4 Lagen à 30 Eier, Lieferung inkl. 8 Lagen, Größe Lage: 28 x 28 cm**  
with airtight cover, capacity: 4 trays of 30 eggs, delivery with 8 trays, size of tray: 28 x 28 cm  
capacidad para 4 bandejas de 30 huevos, tapa hermética, se entrega con 8 bandejas, formato bandejas 28 x 28 cm, apto para lavavajillas  
pour 4 plateaux de 30 oeufs chacun, apte pour 4 plateaux plats, couvercle hermétique, livré avec 8 plateaux, dimension plateau 28x28 cm, lavable en lave-vaisselle

	cm	↑ cm	GN	€
82419	35,4 x 32,5	20	2/3	39,90

10 Lagen / 10 trays / 10 bandejas / 10 plateaux

82420				26,00
-------	--	--	--	-------



**Wanne**  
container  
cubeta  
bac



	cm	↑ cm	ltr.	€
11940	61 x 44	15	25	25,40



**Wanne**  
container  
cubeta  
bac



	cm	↑ cm	ltr.	€
11950	55 x 42	14	20	12,40





**Profi-Eimer**  
bucket  
cubo  
seau



mit Ausgießer und geprägter Maßskalierung innen  
with spout and embossed dimension scaling inside  
con pico y escala de medición en relieve en el interior  
avec bec verseur et échelle de mesure en relief à l'intérieur

	Ø cm	↑ cm	ltr.	Farbe / Colour	€
30075	28,5	28,5	10,5	White	12,90
30076	33,0	32,0	17,0	White	16,50
30077	28,5	28,5	10,5	Black	12,90
30078	33,0	32,0	17,0	Black	16,50



mit Griff  
with handle



Maßskalierung innen  
dimension scaling inside



Auslaufnase für sicheres Handling  
discharge nose for safe handling



**Trichter „PROFI“**  
funnel  
embudo  
entonnoir



mit Öse  
with eyelet  
con ojal  
avec œillet

	Ø cm	Ø mm Durchlass		€
30065	6	8		1,10
30066	8	11		1,30
30067	10	12		1,50
30068	12	12		2,20
30069	14	15		4,40
30070	17	17	mit Sieb / incl. strainer	6,20
30071	21	20	mit Sieb / incl. strainer	7,60



erleichtert das Einfüllen  
facilitates filling



Anwendungsmöglichkeit  
applicability



mit einsetzbarem Sieb  
incl. insertable strainer





# Bar, Café & Drinkware

TABLE LAMPS .....	436
BOTTLE COOLERS .....	442
BEVERAGE DISPENSERS .....	454
DRINKING CUPS .....	456
MOSCOW MULE .....	460
MUGS .....	463
SHAKERS .....	466
JIGGERS .....	468
MUDDLERS .....	470
BAR SPOONS .....	471
BAR STRAINERS .....	472
DRIP MATS .....	474
STRAWS .....	475
ICE BUCKETS .....	476
ICE CUBE MAKERS .....	478
TONGS .....	479
POURERS .....	480
CORKSKREWS   BARBLADES .....	482
CONFERENCE BOTTLE COOLER .....	483
LEMON SQUEEZERS .....	484
TEAPOTS .....	486
BARISTA .....	488
TO GO .....	497
DRINKING BOTTLES .....	499
TRAYS .....	500
FAST FOOD TRAYS .....	504
BILL PRESENTERS   CRUMBERS .....	505
ASHTRAYS .....	506
BINS .....	510



# TABLE LAMPS



Die APS LED-Tischleuchten sind wiederaufladbare, kabellose, batteriebetriebene Leuchten. Ein Knopf an der Unterseite ermöglicht das Ein- und Ausschalten. Ausgestattet mit einem Dimmschalter, schaffen diese Leuchten ein perfektes Ambiente für Ihr Wohlbefinden und bieten bis zu 15-20 Stunden Betrieb mit einer einzigen Ladung. Die Leuchten sind sowohl für den Innen- als auch für den Außenbereich geeignet. Jede Leuchte wird mit einer Kontaktladestation geliefert; das Ladegerät und die Fernbedienung sind ebenfalls im Lieferumfang enthalten. Sie sind einfach aufzuladen und aufzubewahren, da sie magnetisch befestigt werden können, und verbrauchen wenig Strom.

The APS LED Table Lamps are rechargeable battery-powered cordless lamps. A "push" control on the bottom allows switching on/off. Equipped with a dimmer switch, these lamps create a perfect ambiance for you your well-being and offer up to 15-20 hours of operation on a single charge. The lamps are suitable for both indoor and outdoor use. Each lamp comes with a contact charging base; the battery charger and remote control are also included. They are easy to charge and store with magnetic connectors and low in LED power consumption.

Las lámparas de mesa LED de APS son lámparas inalámbricas recargables que funcionan con pilas. Un mando "push" situado en la parte inferior permite encenderlas y apagarlas. Equipadas con un regulador de intensidad, estas lámparas crean un ambiente perfecto para su bienestar y ofrecen hasta 15-20 horas de funcionamiento con una sola carga. Las lámparas son perfectas para su uso tanto en el interior como para el exterior. Cada lámpara viene con una estación de carga por contacto; el cargador de pilas y el mando a distancia también están incluidos. Son fáciles de cargar y almacenar gracias a sus conectores magnéticos y tienen un bajo consumo de energía LED.

Les lampes de table LED d'APS sont des lampes rechargeables, sans fil et fonctionnant sur piles. Un bouton poussoir ("push") situé sur le dessous permet de les allumer et de les éteindre. Equipées d'un variateur de lumière, ces lampes créent une ambiance parfaite pour votre bien-être et offrent jusqu'à 15-20 heures de fonctionnement avec une seule charge. Les lampes conviennent aussi bien à l'intérieur qu'à l'extérieur. Chaque lampe est livrée avec une station de recharge à contact ; le chargeur de batterie et la télécommande sont également inclus. Elles sont faciles à charger et à ranger grâce à des connecteurs magnétiques et consomment peu d'énergie.

NEW



17000



17001



17002

Tischleuchte „MERLE“

table lamp  
lámpara de mesa  
lampe de table



inklusive Ladestation, USB Ladekabel (ohne Netzteil), Fernbedienung inkl. Batterie

charging station included, USB charging cable (without mains adapter), remote control incl. battery  
con estación de carga, cable de carga USB (sin adaptador de red), mando a distancia incl. batería  
avec station de charge, câble de charge USB (sans bloc d'alimentation), télécommande avec batterie

	Ø cm	↑ cm	Farbe / Colour	€
17000	11	30,5		66,00
17001	11	30,5		66,00
17002	11	30,5		66,00



# TABLE LAMPS



**Tischleuchte „FINN“**  
 table lamp  
 lámpara de mesa  
 lampe de table



**inklusive Ladestation, USB Ladekabel (ohne Netzteil), Fernbedienung inkl. Batterie**  
 charging station included, USB charging cable (without mains adapter), remote control incl. battery  
 con estación de carga, cable de carga USB (sin adaptador de red), mando a distancia incl. batería  
 avec station de charge, câble de charge USB (sans bloc d'alimentation), télécommande avec batterie

	Ø cm	↑ cm	Farbe / Colour	€
17006	13	25		49,00

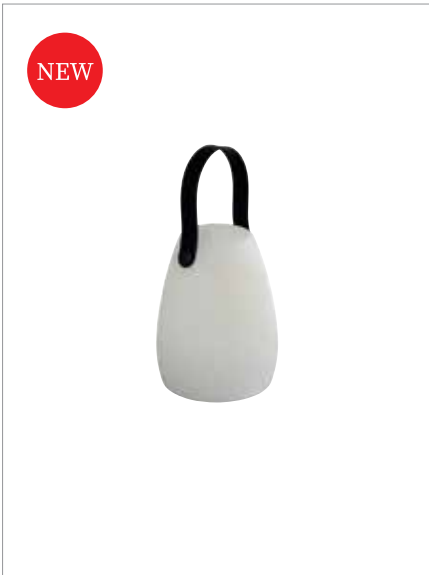

Tischleuchte „NIELS“

table lamp  
lámpara de mesa  
lampe de table

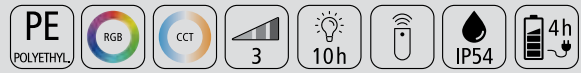

inklusive Ladestation, USB Ladekabel (ohne Netzteil), Fernbedienung inkl. Batterie

charging station included, USB charging cable (without mains adapter), remote control incl. battery  
con estación de carga, cable de carga USB (sin adaptador de red), mando a distancia incl. batería  
avec station de charge, câble de charge USB (sans bloc d'alimentation), télécommande avec batterie

	Ø cm	↑ cm	Farbe / Colour	€
17007	11,5	16		36,00



Tischleuchte „CLEO“

table lamp  
lámpara de mesa  
lampe de table



inklusive Ladestation, USB Ladekabel (ohne Netzteil), Fernbedienung inkl. Batterie

charging station included, USB charging cable (without mains adapter), remote control incl. battery  
con estación de carga, cable de carga USB (sin adaptador de red), mando a distancia incl. batería  
avec station de charge, câble de charge USB (sans bloc d'alimentation), télécommande avec batterie

	Ø cm	↑ cm	Farbe / Colour	€
17003	12	30,5		69,00
17004	12	30,5		69,00
17005	12	30,5		69,00

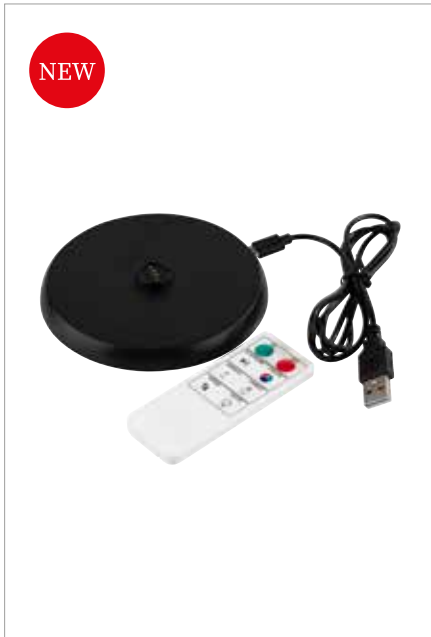

NEW

**Ersatzteilset für Tischleuchten**

spare parts set for table lamp  
set de repuesto para lámpara  
set de pièces de rechange

ABS  
KUNSTSTOFF

Set bestehend aus:

- Ladeplatte
- Kabel (USB A auf USB C)
- Fernbedienung inklusive Batterie

set consisting of:

- charging plate
- cable (USB A auf USB C)
- remote control incl. battery

set compuesto por:

- placa de carga
- cable (USB A a USB C)
- mando a distancia incl. batería

set composé de:

- plaque de chargement
- câble (USB A vers USB C)
- télécommande avec batterie

	cm	↑ cm		Farbe / Colour	€
17023	11	1		■	7,90



NEW

**Rohre für Ladestation**

tubes for charging station  
tubos para estación de carga  
tubes pour station de charge

METALL

passend zu Ladestation

suitable for charging station

para estación de carga

pour station de charge

	Ø cm	↑ cm	fits to	pcs.	Farbe / Colour	€
17022	2	43	17020, 17021	4	■	9,00



NEW

**Ladestation, 6-fach**

charging station, 6-fold  
estación de carga, 6 vías  
station de charge, 6 places

ABS  
KUNSTSTOFF

Platzsparend und transportsicher!

Die Tischleuchten werden auf die magnetischen Kontakte der Ladestation gestellt und können nicht von der Station fallen – kippsicherer Transport! Zwei Ladestationen können mit Hilfe von vier Verbindungsröhren (Art.-Nr. 17022) als Doppeldecker-Ladestation verbunden werden – mit einem Kabel können bis zu 12 Leuchten gleichzeitig geladen werden.

Space-saving and transport-safe!

The table lamps are placed on the magnetic contacts of the charging station and cannot fall off the station - tilt-proof transport! Two charging stations can be connected as a double-decker charging station using four connecting tubes (art. no. 17022) - up to 12 lights can be charged simultaneously with one cable.

Ahorro de espacio y transporte seguro.

Las lámparas de mesa se colocan en los contactos magnéticos de la estación de carga y no pueden caerse de la estación - ¡transporte antivuelco! Se pueden conectar dos estaciones de carga como estación de carga de dos pisos utilizando cuatro tubos de conexión (ref. 17022) - se pueden cargar hasta 12 lámparas simultáneamente con un solo cable.

Peu encombrante et sûre pour le transport !

Les lampes de table sont placées sur les contacts magnétiques de la station de recharge et ne peuvent pas tomber de la station - transport sans risque de basculement ! Deux stations de charge peuvent être reliées à l'aide de quatre tubes (art. n° 17022) de liaison pour former une station de charge à deux étages - un câble permet de charger jusqu'à 12 lampes simultanément.

	cm	↑ cm		Farbe / Colour	€
17020	43 x 31,5	5		■	138,00





NEW



**Ladestation, 15-fach**  
charging station, 15-fold  
estación de carga, 15 vías  
station de charge, 15 places



**Platzsparend und transportsicher!**

Die Ladestation passt maßlich perfekt auf den Servier-/Transportwagen (Art.-Nr. 11977). Die Tischleuchten werden auf die magnetischen Kontakte der Ladestation gestellt und können nicht von der Station fallen – kippsicherer Transport! Zwei Ladestationen können mit Hilfe von vier Verbindungsrohren (Art.-Nr. 17022) als Doppeldecker-Ladestation verbunden werden – mit einem Kabel können bis zu 30 Leuchten gleichzeitig geladen werden.

Space-saving and transport-safe!

The charging station fits perfectly on the serving/transport trolley (art. no. 11977). The table lamps are placed on the magnetic contacts of the charging station and cannot fall off the station - tilt-proof transport! Two charging stations can be connected as a double-decker charging station using four connecting tubes (art. no. 17022) - up to 30 lights can be charged simultaneously with one cable.

Ahorro de espacio y transporte seguro.

La estación de carga encaja perfectamente en el carro de servicio/transporte (ref. 11977). Las lámparas de mesa se colocan en los contactos magnéticos de la estación de carga y no pueden caerse de la estación - ¡transporte antivuelco! Se pueden conectar dos estaciones de carga como estación de carga de dos pisos utilizando cuatro tubos de conexión (ref. 17022) - se pueden cargar hasta 30 lámparas simultáneamente con un solo cable.

Peu encombrante et sûre pour le transport !

Les dimensions de la station de chargement s'adaptent parfaitement au chariot de service/transport (art. n° 11977). Les lampes de table sont placées sur les contacts magnétiques de la station de recharge et ne peuvent pas tomber de la station - transport sans risque de basculement ! Deux stations de charge peuvent être reliées à l'aide de quatre tubes (art. n° 17022) de liaison pour former une station de charge à deux étages - un câble permet de charger jusqu'à 30 lampes simultanément.

	cm	↑ cm	Farbe / Colour	€
17021	75 x 43	5	■	230,00



**Servier- / Transportwagen**

service trolley  
carro de servicio  
chariot de service



mit 2 Borden, Bordmaße 83 x 51 cm, Abstand zwischen den Borden 56 cm, Tragfähigkeit 80 kg, 4 Lenkrollen, davon 2 feststellbar, Lieferung demontiert, einfache Montage

with 2 trays, trays 83 x 51 cm, size between the trays 56 cm, total load capacity 80 kg, 4 wheels with 2 brakes, unassembled, simple assembly

	cm	↑ cm	€
11977	91 x 59	93	146,00

## BOTTLE COOLERS



### Wein- / Sektkühler

wine / champagne bowl  
cubitera para vino y cava  
seau à vin ou champagne



**innen matt poliert, außen hochglanzpoliert, mit massiven Knopf-Griffen, extra stabiler eingerollter Rand, schwere Ausführung**

outside mirror polished, inside matt polished, with solid knob handles, rolled edge, heavy quality  
exterior pulido brillante, interior pulido mate, asas de botón robustas, borde redondeado, alta calidad  
extérieur poli brillant, intérieur poli mat, 2 poignées robuste en forme de bouton, bord arrondi, haute qualité

	Ø cm	↑ cm	ltr.	€
36028	21,5 / 16	22	4	34,00



### Wein- / Sektkühler „HAMMERSCHLAG“

wine / champagne bowl  
cubitera para vino y cava  
seau à vin ou champagne



**hochglanzpoliert, mit massiven Ring-Griffen, eingerollter Rand**

mirror polished, with solid ring handles, rolled edge, hammered  
pulido brillante, con 2 anillos macizos, borde redondeado, repujado  
brillant, 2 anneaux massifs, bord arrondi, surface martelée

	Ø cm	↑ cm	ltr.	€
36026	21 / 17	21,5	4	19,00



### Wein- / Sektkühler

wine / champagne bowl  
cubitera para vino y cava  
seau à vin ou champagne



**innen matt poliert, außen hochglanzpoliert, mit massiven Griffen, Rand eingerollt**

outside mirror polished, inside matt polished, with massive handles, rolled edge  
exterior pulido brillante, interior pulido mate, 2 asas macizas, borde redondeado  
extérieur poli brillant, intérieur poli mat, 2 anses massives, bord rond

	Ø cm	↑ cm	ltr.	€
36025	21 / 15	21	3,5	18,00



### Wein- / Sektkühler

wine / champagne bowl  
cubitera para vino y cava  
seau à vin ou champagne



**matt poliert, Hohlgriffe / matt polished, hollow handles / pulido mate, con asas huecas / poli mat, 2 boutons creux**

	Ø cm	↑ cm	ltr.	€
36021	20 / 15	20,5	4	16,00



### Wein- / Sektkühler

wine / champagne bowl  
cubitera para vino y cava  
seau à vin ou champagne



**aussen hochglanzpoliert, innen matt poliert, mit Ring-Griffen**

outside mirror polished, inside matt polished, with ring handles  
exterior pulido brillante, interior pulido mate, con 2 asas anillos  
extérieur poli brillant, intérieur poli mat, avec 2 anneaux

	Ø cm	↑ cm	ltr.	€
36020	20 / 15	19	3	14,80



**Mini-Eiseimer / Mini-Sektkühler**

ice bucket  
cubitera clásica  
seau à glaçons classique



	Ø cm	↑ cm	litr.	€
36003	10,5	10	0,5	8,60
36004	13,0	13	1,0	11,00



**Flaschenkühler „MOSCOW MULE“**

bottle cooler  
enfriador de botellas  
rafraîchisseur de bouteilles

**Edelstahl-Flaschenkühler, Antik-Kupfer-Look**  
stainless steel cooler, copper antique look  
enfriador de acero inoxidable, cobre estilo antiguo  
rafraîchisseur en acier inox, cuivre style antique



	Ø cm	↑ cm	litr.		€
93330	20	21	5	copper-antique-hammered	54,00



**Wein- / Sektkühler**

wine / champagne bowl  
cubitera para vino y cava  
seau à vin ou champagne

**schwarz matt, mit 2 Griffen, extra stabiler eingerollter Rand**  
black matt, with 2 handles, rolled edge  
negro mate, con 2 asas, borde redondeado  
noir mat, avec 2 poignées, bord arrondi



	Ø cm	↑ cm	litr.	€
36115	21,5 / 15	22	5	44,00



**Wein- / Sektkühler**

wine / champagne bowl  
cubitera para vino y cava  
seau à vin ou champagne

**glasklar, mit Tragegriff**  
transparent, handle on the side  
transparente, con un asa en el lateral  
transparent, avec poignée



	cm	↑ cm	litr.	€
36055	23 x 22	27,5	3	23,00



**Wein- / Sektkühler**

wine / champagne bowl  
cubitera para vino y cava  
seau à vin ou champagne

**glasklarer Rand, transparent gefrostet**  
edge transparent, body transparent frosted  
borde transparente, cuerpo transparente efecto glaseado  
bord transparent, corps poli mat



	Ø cm	↑ cm	litr.	€
36066	22 / 14	23	4	9,80

## BOTTLE COOLERS



### Flaschenkühler

bottle cooler  
enfriador de botella  
rafraîchisseur de bouteille

**doppelwandig für beste Isolierung, außen Hammerschlag-Optik**

double-walled for best insulation, outside: hammered surface

doble pared para un mejor aislamiento, exterior: aspecto martillado

double paroi pour une meilleur isolation, extérieur: surface martelée



	Ø cm	↑ cm	ltr.	Farbe / Colour		€
36120	33	20	8		stainless	68,00
36121	33	20	8		copper-look	68,00



Präsentationsmöglichkeit  
presentation examples



### Wein- / Sektkühler „XL“

wine / champagne bowl  
cubitera para vino y cava  
seau à vin ou champagne

**gehämmerte Oberfläche, mit 2 seitlichen Eingriffen**

hammered surface, with 2 handles on the side

superficie martillada, con 2 asas

surface martelée, avec 2 poignées



	cm	↑ cm	ltr.	Farbe / Colour		€
36111	30 x 23,5	23	7		copper-look	65,00
36112	30 x 23,5	23	7		gunmetal-look	65,00



### Wein- / Sektkühler „LARGE“

wine / champagne bowl  
cubitera para vino y cava  
seau à vin ou champagne

**gehämmerte Oberfläche, mit 2 seitlichen Eingriffen, für 1-2 Flaschen**

hammered surface, with 2 handles on the side, for 1-2 bottles

superficie martillada, con 2 asas, para 1-2 botellas

surface martelée, avec 2 poignées, pour 1-2 bouteilles



	cm	↑ cm	ltr.	Farbe / Colour		€
36108	25,5 x 19	20	3,9		copper-look	35,00
36109	25,5 x 19	20	3,9		gunmetal-look	35,00



### Wein- / Sektkühler „SMALL“

wine / champagne bowl  
cubitera para vino y cava  
seau à vin ou champagne

**gehämmerte Oberfläche, für 1 Flasche**

hammered surface, for 1 bottle

superficie martillada, para 1 botella

surface martelée, pour 1 bouteille



	cm	↑ cm	ltr.	Farbe / Colour		€
36106	20,5 x 14	17	2,1		copper-look	26,00
36107	20,5 x 14	17	2,1		gunmetal-look	26,00



**Ständer für Wein- / Sektkühler**

stand for wine / champagne bowl  
pie porta champañera / vino  
pied pour seau à champagne / vin



hochglanzpoliert, schwerer standsicherer Fuß, Innendurchmesser der Schale Ø 17,5 cm  
mirror polished, heavy foot, inner bowl Ø 17,5 cm  
acabado pulido efecto brillante, bol interior de Ø 17,5 cm  
brillant, intérieur support Ø 17,5 cm

	Ø cm	↑ cm	€
36069	17,5 / 26,5	73	118,00



Wein- / Sektkühler no. 36028  
wine / champagne bowl no. 36028  
cubitera para vino y cava no. 36028  
seau à vin ou champagne no. 36028



**Ständer für Wein- / Sektkühler**

stand for wine / champagne bowl  
pie porta champañera / vino  
pied pour seau à champagne / vin



hochglanzpoliert, schwerer standsicherer Fuß, Innendurchmesser der Schale Ø 15 cm  
mirror polished, heavy foot, inner bowl Ø 15 cm  
acabado pulido efecto brillante, bol interior de Ø 15 cm  
brillant, intérieur support Ø 15 cm

	Ø cm	↑ cm	€
36068	15 / 28	68	90,00



**Ständer für Wein- / Sektkühler**

stand for wine / champagne bowl  
pie porta champañera / vino  
pied pour seau à champagne / vin



schwarz matt, schwerer standsicherer Fuß, Innendurchmesser der Schale Ø 15 cm  
black matt, heavy stable foot, inner bowl Ø 15 cm  
negro mate, pie pesado y estable, bol interior de Ø 15 cm  
noir mat, pied lourd et stable, intérieur support Ø 15 cm

	Ø cm	↑ cm	€
36116	19,5 / 26,5	71,5	100,00

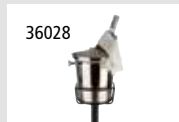
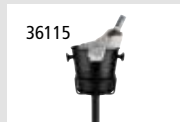

**Tischhalterung für Sektkühler**

champagne bucket table holder  
soporte champañera universal  
porte-seau à champagne



aus 8 mm starkem Stahldraht, passen zu allen lieferbaren Sektkühlern, innen Ø-Ring: 18 cm  
8 mm chrome plated wire, suitable for all available champagne buckets, inner ring Ø 18 cm  
alambre cromado 8 mm, para todas las champañeras, anillo interior Ø 18 cm  
fil chromé 8 mm, pour tous les seaux à champagne, anneau intérieur Ø 18 cm

	cm	↑ cm	€
30332	49 x 20	17	18,00

## BOTTLE COOLERS



### Flaschenkühler

bottle cooler  
enfriador de botellas  
rafraîchisseur de bouteilles

**doppelwandig für beste Isolierung, außen hochglanzpoliert, innen matt poliert**

double wall cooler keeps the temp. for a long time, outs. mirror polished, inside matt polished  
champañera inox de doble pared, interior pulido mate, exterior pulido brillante  
seau inox double paroi, maintient le froid plus longt., intérieur poli mat, extérieur poli brillant



	Ø cm	↑ cm	ltr.	€
36077	31	19	10	102,00



### Champagnerkühler

champagne bowl  
cubo champañera  
seau à champagne

**hochglanzpoliert, doppelwandig für beste Isolierung**

mirror polished, double wall cooler keeps the temp. for a long time  
pulido brillante con champañera inox de doble pared  
poli brillant, double paroi, maintient le froid plus longtemps



	Ø cm	↑ cm	ltr.	€
36044	44 / 25	24	10,5	102,00



### Champagnerkühler

champagne bowl  
cubo champañera  
seau à champagne

**hochglanzpoliert**

mirror polished  
pulido brillante  
poli brillant



	Ø cm	↑ cm	ltr.	€
36045	40,5 / 27,5	22,5	13,5	60,00



### Champagnerkühler

champagne bowl  
cubo champañera  
seau à champagne

**hochglanzpoliert, Rand matt poliert**

mirror polished, edge matt polished  
pulido brillante, borde pulido mate  
poli brillant, bord poli mat



	Ø cm	↑ cm	ltr.	€
36046	45 / 21	23	12	52,00



**Flaschenkühler „BIG BOWL“**

bottle cooler  
enfriador de botella  
rafraîchisseur de bouteille



gehämmerte Oberfläche, innen matt poliert, herausnehmbarer Tropfeinsatz

hammered surface, inside matt polished, removable drip tray  
superficie martillada, interior pulido mate, bandeja de goteo extraíble  
surface martelée, intérieur poli mat, bac d'égouttage amovible

	Ø cm	↑ cm	ltr.	€
36130	37	23	8	240,00



herausnehmbarer  
Tropfeinsatz  
removable drip tray

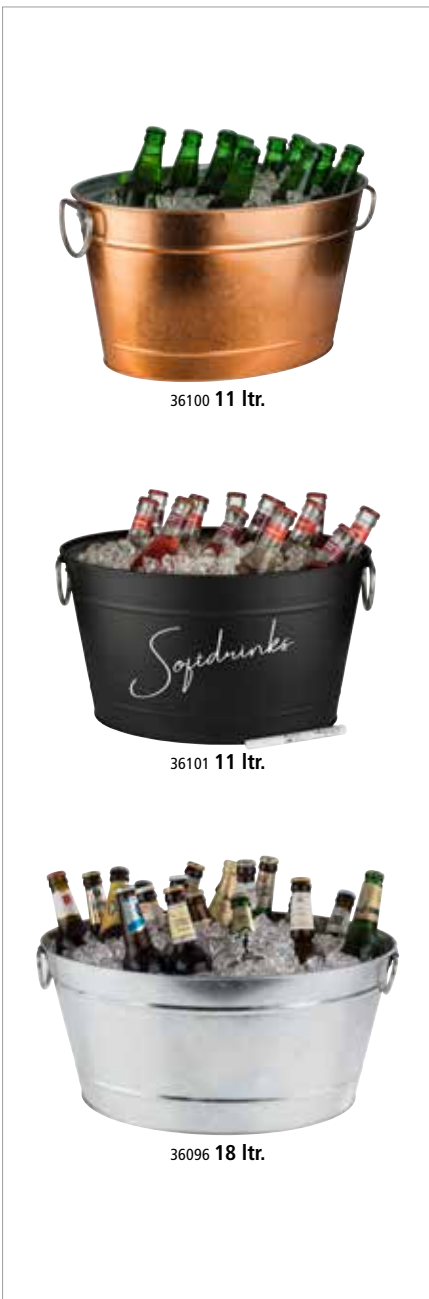

36100 11 ltr.

36101 11 ltr.

36096 18 ltr.

**Getränkewanne „TIN“**

beverage tub  
barreño botellines  
bassine à glace



Metall verzinkt, mit Kunststoffeinsatz  
galvanised metal, with plastic insert  
metal galvanizado, con inserto de plástico  
métal galvanisé, avec insert en plastique

	cm	↑ cm	ltr.	Farbe / Colour	€
36100	40 x 28	22	11	copper-look	36,00
36101	40 x 28	22	11	black-metal-look	31,00
36095	40 x 28	22	11	metal-look	30,00
36096	50 x 23	23	18	metal-look	36,00



mit Kunststoffeinsatz  
with plastic insert  
con inserto de plástico  
avec insert en plastique



71490

Kreidestift zum  
Beschriften | chalk  
marker for writing  
S. 304

## BOTTLE COOLERS



### Wein- / Sektkühler

wine / champagne bowl  
cubitera para vino y cava  
seau à vin ou champagne

**glasklar, für bis zu 6 Flaschen geeignet**  
transparent, suitable for up to 6 bottles  
transparente, para máximo 6 botellas  
transparent, maxi 6 bouteilles



	cm	↑ cm	ltr.	€
36057	47 x 28	23	10	41,00



### Wein- / Sektkühler

wine / champagne bowl  
cubitera para vino y cava  
seau à vin ou champagne

**mit seitlichen Griffen, transparent**  
with lateral handles, transparent  
con asas laterales  
avec poignées latérales



	cm	↑ cm	ltr.	€
36087	32 x 21,5	24,5	7	31,00



36048

### Wein- / Sektkühler

wine / champagne bowl  
cubitera para vino y cava  
seau à vin ou champagne

**mit 2 seitlichen Eingriffen**  
with 2 handles on the side  
con 2 asas  
avec 2 poignées



	cm	↑ cm	ltr.	€
36048	35 x 27	25,5	6	31,00
36052	27 x 20	21	3	17,20



36054

### Wein- / Sektkühler

wine / champagne bowl  
cubitera para vino y cava  
seau à vin ou champagne

**mit 2 seitlichen Eingriffen**  
with 2 handles on the side  
con 2 asas  
avec 2 poignées



	cm	↑ cm	ltr.	€
36054	35 x 27	25,5	6	37,00
36053	27 x 20	21,0	3	22,00





**Wein- / Sektkühler**  
 wine / champagne bowl  
 cubitera para vino y cava  
 seau à vin ou champagne  
**glasklar, für zwei Flaschen**  
 clear, for two bottles  
 transparente, para 2 botellas  
 transparent, pour 2 bouteilles



	cm	↑ cm	ltr.	€
36056	30,5 x 21,5	26	4	22,00



**Flaschenkühler**  
 bottle cooler  
 enfriador de botella  
 rafraîchisseur de bouteille



**transparent, doppelwandig für beste Isolierung, mit Chromrand**  
 transparent, double wall cooler keeps the temperature for a long time, with chrome edg  
 transpar., doble pared mantiene la temperaruta por largo tiempo, borde superior cromado  
 transparent, bord chromé brillant, double paroi pour maintien en température

	Ø cm	↑ cm	Farbe / Colour	€
36032	12 / 10	23		10,00
36034	12 / 10	23		10,00



**Flaschenkühler „PURE“**  
 bottle cooler  
 enfriador de botella  
 rafraîchisseur de bouteille



**doppelwandig für beste Isolierung, glasklar**  
 double wall cooler keeps the temperature for a long time, clear  
 doble pared mantiene la temperaruta por largo tiempo, transparente  
 double paroi pour maintien en température, transparent

	Ø cm	↑ cm	€
36063	13,5 / 10,5	23	9,00
36062	13,5 / 10,5	23	9,00

## BOTTLE COOLERS



### Flaschenkühler „GOLD“

bottle cooler  
enfriador de botella  
rafraîchisseur de bouteille



**Hammerschlag-Optik, doppelwandig für beste Isolierung, für 0,7 - 1,5 Liter-Flaschen**

hammered look, double-walled for best insulation, for 0,7 - 1,5 ltr.-bottles  
martillado, doble pared para un mejor aislamiento, para botellas de 0,7 a 1,5 L.  
martelé, double paroi pour une isolation optimale, pour bouteilles de 0,7 à 1,5 L.

	Ø cm	↑ cm	Farbe / Colour	€
36128	12 / 10	20		26,00



### Flaschenkühler „COPPER“

bottle cooler  
enfriador de botella  
rafraîchisseur de bouteille



**Hammerschlag-Optik, doppelwandig für beste Isolierung, für 0,7 - 1,5 Liter-Flaschen**

double wall cooler keeps the temperature for a long time, hammered look, for 0,7 - 1,5 ltr. bottles  
doble pared para mantener el frío largo tiempo, para botellas de 0,7 - 1,5 ltr.  
double paroi pour une meilleure conservation de la température, pour bouteilles de 0,7 à 1,5 l.

	Ø cm	↑ cm	Farbe / Colour	€
36074	12 / 10	20		26,00



### Flaschenkühler

bottle cooler  
enfriador de botella  
rafraîchisseur de bouteille



**doppelwandig für beste Isolierung, für 0,7 - 1,5 Liter-Flaschen**

double wall cooler keeps the temperature for a long time, for 0,7 - 1,5 ltr. bottles  
con doble pared para mantener el frío largo tiempo, para botellas de 0,7 - 1,5 ltr.  
double paroi pour une meilleure conservation de la température, pour bouteilles de 0,7 à 1,5 l.

	Ø cm	↑ cm	Farbe / Colour	€
36125	12 / 10	20	copper red	24,00
36126	12 / 10	20	blue	24,00
36127	12 / 10	20	black	24,00

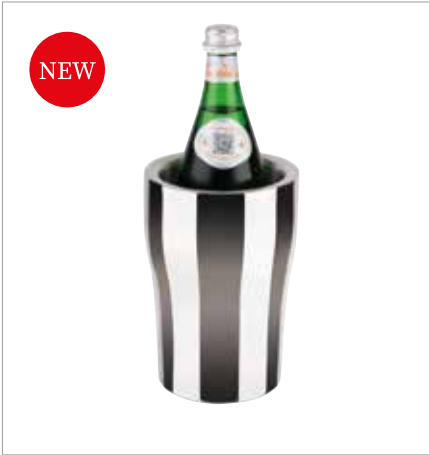

**Flaschenkühler „WAIST“**

bottle cooler  
enfriador de botella  
rafraîchisseur de bouteille

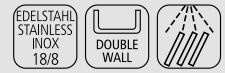

**hochglanzpoliert, doppelwandig für beste Isolierung, für 0,7 - 1,5 Liter-Flaschen**  
mirror polished, double-walled for best insulation, for 0,7 - 1,5 ltr.-bottles  
poli brillante, doble pared para un mejor aislamiento, para botellas de 0,7 a 1,5 L.  
pulido brillante, double paroi pour une isolation optimale, pour bouteilles de 0,7 à 1,5 L.

	Ø cm	↑ cm	Farbe / Colour	€
36129	13 / 10	19		19,00



**Flaschenkühler**

bottle cooler  
enfriador de botella  
rafraîchisseur de bouteille



**matt poliert, doppelwandig für beste Isolierung, für 0,7 - 1,5 Liter-Flaschen**  
matt polished, double wall cooler keeps the temperature for a long time, for 0,7 - 1,5 ltr. bottles  
pulido mate con doble pared para mantener el frio largo tiempo, para botellas de 0,7 - 1,5 ltr.  
poli mat, double paroi pour une meilleure conservation de la température, pour bouteilles de 0,7 à 1,5 l.

	Ø cm	↑ cm	€
36038	12,5 / 10	19	23,00



**Flaschenkühler**

bottle cooler  
enfriador de botella  
rafraîchisseur de bouteille



**matt poliert, doppelwandig für beste Isolierung, für 0,7 - 1,5 Liter-Flaschen**  
matt polished, double wall cooler keeps the temperature for a long time, for 0,7 - 1,5 ltr. bottles  
pulido mate, doble pared para mantener el frio largo tiempo, para botellas de 0,7 - 1,5 ltr.  
poli mat, double paroi pour une meilleure conservation de la température, pour bouteilles de 0,7 à 1,5 l.

	Ø cm	↑ cm	€
36030	12 / 10	20	18,00



**Flaschenkühler „FROSTFIRE“**

bottle cooler  
enfriador de botella  
rafraîchisseur de bouteille



**Antihafbeschichtung / non stick coating / antiadherente / revêtement anti-adhésif**

	Ø cm	↑ cm	ltr.	Farbe / Colour	€
36140	11,5 / 11	15	1,5	black/silver	16,00



auch als Dressingtopf verwendbar  
also usable as a dressing pot

## BOTTLE COOLERS



### Flaschenkühler „ELEMENT“

bottle cooler  
enfriador de botella  
rafraîchisseur de bouteille

**möbelschonende Unterseite**  
non-scratching undersurface  
base anti rayaduras  
base revêtement antirayures



	Ø cm	↑ cm	Farbe / Colour	€
36131	12 / 10	19		20,00



### Flaschenkühler „ELEMENT“

bottle cooler  
enfriador de botella  
rafraîchisseur de bouteille

**Beton, geriffelte Oberfläche, möbelschonende Unterseite**  
concrete, ribbed surface, non-scratching undersurface  
hormigón, superficie ranurada, base anti rayaduras  
béton, surface rainurée, base revêtement antirayures



	Ø cm	↑ cm	Farbe / Colour	€
36122	13 / 10	19,5	white	20,00
36123	13 / 10	19,5	concrete	20,00
36124	13 / 10	19,5	green	20,00



Oberflächenansicht  
structural view



### Flaschenkühler „ELEMENT“

bottle cooler  
enfriador de botella  
rafraîchisseur de bouteille

**Beton, möbelschonende Unterseite**  
concrete, non-scratching undersurface  
hormigón, base anti rayaduras  
béton, base revêtement antirayures



	Ø cm	↑ cm	Farbe / Colour	€
36104	12 / 10	19	rose	20,00
36105	12 / 10	19	green	20,00



### Flaschenkühler „ELEMENT“

bottle cooler  
enfriador de botella  
rafraîchisseur de bouteille

**Beton, möbelschonende Unterseite**  
concrete, non-scratching undersurface  
hormigón, base anti rayaduras  
béton, base revêtement antirayures



	Ø cm	↑ cm	Farbe / Colour	€
36090	12 / 10	19	concrete	20,00
36099	12 / 10	19	black	20,00



**Pitcher**  
pitcher  
jarra  
pichet



	Ø cm	↑ cm	ltr.	€
93105	13	21	1,5	10,40



einfaches Eingießen  
easy pouring



93091 1,5 ltr.

**Pitcher**  
pitcher  
jarra  
pichet



	Ø cm	↑ cm	ltr.	€
93090	12,5	17,5	1,0	9,00
93091	13,5	20,0	1,5	10,00

passende Deckel / fitting lids / tapa adecuadas / couvercles appropriées

	cm	↑ cm	fits to	€
93092	13,0	1,5	93090	1,90
93093	14,0	1,5	93091	1,90



Deckel mit Klappe  
lid with flap



einfaches Eingießen  
easy pouring



stapelbar  
stackable



**Kühlmanschette „CHAMPAGNE“**

cool collar  
funda de frío  
housse isotherme



für Sekt- / Champagnerflaschen, einfach im Gefrierfach einfrieren, komplette Flasche wird in 5 Min. auf angenehme Trinktemperatur gekühlt, außen reißfestes Stoffgewebe, innen Kunststoff mit Kühlgel gefüllt, unbegrenzt wiederverwendbar

for bottles of champagne, simply to freeze in the freezer, complete bottles will be cooled down in only 5 minutes, tearproof cloth outside, plastic filled with gel inside, unlimited reusable  
para botellas de cava o champán simplemente congelándola en el congelador, la botella entera se enfriará en 5 minutos, funda de plástico muy robusta, rellena con un gel congelante reutilizable ilimitadamente

pour bouteilles de vin ou champagne, la housse est préalablement stockée au congélateur, où elle accumule le froid, ensuite elle refroidit une bouteille en quelques minutes, plastique résistant, contient un liquide congelant, à réutiliser de façon illimitée

	Ø cm	↑ cm	€
36075	11	18	7,00



**Weinflaschenhalter**

winebottle-stand  
soporte para botella de vino  
porte-bouteille



	cm	↑ cm	€
30333	22 x 6	20,5	9,40



# BEVERAGE DISPENSERS



## Getränkespender „INDUSTRIAL“

beverage dispenser  
dispensador de bebidas  
distributeur de boissons



Behälter aus Glas, Zapfhahn aus Edelstahl, Fuß und Deckel aus Metall, schwarz, Antirutschmatte aus Silikon

glass container, stainless steel tap, base and lid in black metal, silicone non-slip mat

recipiente de vidrio, grifo de acero inoxidable, base y tapa de metal negro, tapete antideslizante de silicona

réceptien en verre, robinet en acier inox, pied et couvercle en métal noir, tapis antidérapant en silicone

	Ø cm	↑ cm	ltr.		€
10450	20	45	7	inkl. Gestell / incl. stand	100,00



Antirutschmatte aus Silikon  
silicone anti-slip mat



## Getränkespender „URBAN“

beverage dispenser  
dispensador de bebidas  
distributeur de boissons



Behälter aus Glas, Zapfhahn aus Edelstahl, Fuß und Deckel aus Metall, schwarz, Antirutschmatte aus Silikon

glass container, stainless steel tap, base and lid in black metal, silicone non-slip mat

recipiente de vidrio, grifo de acero inoxidable, base y tapa de metal negro, tapete antideslizante de silicona

réceptien en verre, robinet en acier inox, pied et couvercle en métal noir, tapis antidérapant en silicone

	Ø cm	↑ cm	ltr.		€
10451	22	45	7	inkl. Gestell / incl. stand	100,00



Antirutschmatte aus Silikon  
silicone anti-slip mat



## Eiswasserröhre

ice cube cooling tube  
tubo enfriador para cubitos  
tube pour glaçons



	Ø cm	↑ cm	passend für Getränkenspender / fits to drink dispenser	€
10849	11	24	10400, 10403, 10450, 10451, 10855	8,80



**Getränkespender „ELEMENT“**

beverage dispenser  
dispensador de bebidas  
distributeur de boissons



**Behälter aus Glas, Zapfhahn aus Edelstahl, Fuß und Deckel aus Beton**

glass container, stainless steel tap, stand and lid made of concrete  
recipiente de vidrio, grifo de acero inoxidable, soporte y tapa de hormigón  
récipient en verre, robinet en acier inox, support et couvercle en béton

	Ø cm	↑ cm	ltr.		€
10400	22	45	7	inkl. Gestell / incl. stand	120,00



**Getränkespender „OLD FASHIONED“**

beverage dispenser  
dispensador de bebidas  
distributeur de boissons



**Behälter aus Glas, Zapfhahn aus Edelstahl, Gestell schwarz**

glass container, stainless steel tap, black stand  
recipiente de vidrio, grifo de acero inoxidable, soporte negro  
récipient en verre, robinet en acier inox, support noir

	Ø cm	↑ cm	ltr.		€
10409	27	50,5	7	inkl. Gestell / incl. stand	85,00

Ersatz-Gestell / stand / soporte de recambio / support de remplacement

	Ø cm	↑ cm		€
10410	27	31,5		17,00

Ersatz-Glas / replacement glass / cristal de recambio / vitre de rechange

	Ø cm	↑ cm	ltr.		€
10411	19	36,5	7		49,00

Ersatz-Zapfhahn 10409 / replacement tap for 10409

				€
10718				26,00



**Getränkespender „ASIA“**

beverage dispenser  
dispensador de bebidas  
distributeur de boissons



**Behälter aus Glas, Zapfhahn aus Edelstahl, Fuß und Deckel aus Holz**

glass container, stainless steel tap, wooden stand and lid  
recipiente de vidrio, grifo de acero inoxidable, soporte y tapa de madera  
récipient en verre, robinet en acier inox, support et couvercle en bois

	Ø cm	↑ cm	ltr.		€
10403	24,5	45,5	7	inkl. Gestell / incl. stand	98,00

Ersatz-Fuß / base / soporte de recambio / support de remplacement

	Ø cm	↑ cm		€
10404	24,5	15		26,00

Ersatz-Deckel / replacement lid / tapa de recambio / couvercle de rechange

	Ø cm	↑ cm		€
10405	14,0	5		10,40



**Tropfenschale, 2-teilig**

drip tray, 2 pcs.  
aros anti-goteo, set de 2  
anneaux coupe-gouttes, set de 2



	Ø cm	↑ cm	Farbe / Colour	€
10851	9,5	1,5	white	8,00
10853	9,5	1,5	anthracite	8,00
10841 <b>NEW</b>	9,5	1,5	black	8,00

NEW

# PERFECTION



NEW



## Sektglas „PERFECTION“

champagne glass  
copa de champán  
flûte à champagne



	Ø cm	↑ cm	ltr.	VE / unit	€/ pc.
10540	5	23	0,19	12	6,00

NEW



## Weißweinglas „PERFECTION“

white wine glass  
copa de vino blanco  
verre à vin blanc



	Ø cm	↑ cm	ltr.	VE / unit	€/ pc.
10541	8	21,5	0,32	12	7,00

NEW



## Rotweinglas „PERFECTION“

red wine glass  
copa de vino tinto  
verre à vin rouge



	Ø cm	↑ cm	ltr.	VE / unit	€/ pc.
10542	10,5	21	0,6	12	8,00



# LINEA

5 SIZES  
5 COLOURS



UNZERBRECHLICH  
UNBREAKABLE



10577  
0,30 ltr.



10585  
0,15 ltr.



10561  
0,22 ltr.



10573  
0,40 ltr.



10569  
0,50 ltr.

Trinkbecher „LINEA“  
drinking cups  
vasos  
gobelets



Die elegant facettierten Bechergläser LINEA lassen sich vielseitig im Bar-, Club-, Pool- und Buffetbereich verwenden. Sowohl die transparenten als auch die farbigen Modelle setzen in jedem Ambiente edle Akzente. Dank ihrer perfekten Stapelbarkeit werden sie platzsparend aufbewahrt und transportiert.

The elegantly faceted tumbler glasses LINEA can be used in a variety of ways in the bar, club, pool and buffet areas. Both the transparent and coloured models set elegant accents in any ambience. Thanks to their perfect stackability, they are space-saving to store and transport.

Los vasos LINEA, elegantemente facetados, pueden utilizarse de diversas maneras en el bar, el club, la piscina y el buffet. Tanto los modelos transparentes como los de color ponen elegantes acentos en cualquier ambiente. Gracias a su perfecta apilabilidad, ahorran espacio para su almacenamiento y transporte.

Les verres LINEA élégamment facetés peuvent être utilisés de manière polyvalente dans les bars, les clubs, les piscines et les buffets. Les modèles transparents et colorés apportent une touche de noblesse dans chaque ambiance. Grâce à leur parfaite empilabilité, ils se rangent et se transportent avec un minimum d'encombrement.

	Ø cm	↑ cm	ltr.	VE	Farbe / Colour	€/ pc.
10560	6,5	8,0	0,15	48	crystal clear	2,50
10561	8,5	8,0	0,22	48	crystal clear	2,80
10562	8,5	10,0	0,30	48	crystal clear	3,30
10563	8,5	12,0	0,40	48	crystal clear	3,70
10564	8,5	15,0	0,50	48	crystal clear	4,10
10565	6,5	8,0	0,15	48	french grey	2,60
10566	8,5	8,0	0,22	48	french grey	2,90
10567	8,5	10,0	0,30	48	french grey	3,40
10568	8,5	12,0	0,40	48	french grey	3,80
10569	8,5	15,0	0,50	48	french grey	4,20
10570	6,5	8,0	0,15	48	light green	2,60
10571	8,5	8,0	0,22	48	light green	2,90
10572	8,5	10,0	0,30	48	light green	3,40
10573	8,5	12,0	0,40	48	light green	3,80
10574	8,5	15,0	0,50	48	light green	4,20
10575	6,5	8,0	0,15	48	light pink	2,60
10576	8,5	8,0	0,22	48	light pink	2,90
10577	8,5	10,0	0,30	48	light pink	3,40
10578	8,5	12,0	0,40	48	light pink	3,80
10579	8,5	15,0	0,50	48	light pink	4,20
10585	6,5	8,0	0,15	48	light blue	2,60
10586	8,5	8,0	0,22	48	light blue	2,90
10587	8,5	10,0	0,30	48	light blue	3,40
10588	8,5	12,0	0,40	48	light blue	3,80
10589	8,5	15,0	0,50	48	light blue	4,20

# CRYSTAL



## Trinkbecher „CRYSTAL“

drinking cups

vasos

gobelets

**Kristallglas-Optik, vielseitig einsetzbar, robustes, unzerbrechliches Material, ideal in sensiblen Bereichen wie Pool, Spa, Beach und Wellness einzusetzen**

crystal-glass-look, can be used in versatile ways, a solide and unbreakable material, ideal to be used at pool, spa, beach and wellness areas

aspecto vidrio, se pueden utilizar de muchas maneras diferentes, material sólido e irrompible, ideal para el uso en áreas como piscina, spa, playa y bienestar

ressemble à un verre de cristal, peuvent être utilisés de différentes façons, matériau robuste et incassable, idéal pour une utilisation dans des zones comme la piscine, le spa, la plage et le bien-être



	Ø cm	↑ cm	litr.	VE	Farbe / Colour	€/ pc.
10500	7,0	9,5	0,15	48	crystal clear	3,10
10503	7,5	11,0	0,20	48	crystal clear	3,50
10501	8,0	12,5	0,30	48	crystal clear	4,20
10504	8,5	14,0	0,40	48	crystal clear	4,60
10502	9,0	15,5	0,50	48	crystal clear	5,20
	Ø cm	↑ cm	litr.	VE	Farbe / Colour	€/ pc.
10513	7,0	9,5	0,15	48	blue sky	3,20
10516	7,5	11,0	0,20	48	blue sky	3,60
10514	8,0	12,5	0,30	48	blue sky	4,30
10517	8,5	14,0	0,40	48	blue sky	4,70
10515	9,0	15,5	0,50	48	blue sky	5,30



**5 SIZES  
2 COLOURS**



**UNZERBRECHLICH  
UNBREAKABLE**



10500  
0,15 ltr.



10516  
0,20 ltr.



10501  
0,30 ltr.



10517  
0,40 ltr.



10502  
0,50 ltr.



	Ø cm	↑ cm	ltr.	VE	Farbe / Colour	€/ pc.
10510	7,0	9,5	0,15	48	red star	3,20
10511	8,0	12,5	0,30	48	red star	4,30
10512	9,0	15,5	0,50	48	red star	5,30
	Ø cm	↑ cm	ltr.	VE	Farbe / Colour	€/ pc.
10525	7,0	9,5	0,15	48	french grey	3,20
10526	8,0	12,5	0,30	48	french grey	4,30
10527	9,0	15,5	0,50	48	french grey	5,30
	Ø cm	↑ cm	ltr.	VE	Farbe / Colour	€/ pc.
10528	7,0	9,5	0,15	48	purple	3,20
10529	8,0	12,5	0,30	48	purple	4,30
10530	9,0	15,5	0,50	48	purple	5,30
	Ø cm	↑ cm	ltr.	VE	Farbe / Colour	€/ pc.
10531	7,0	9,5	0,15	48	apricot	3,20
10532	8,0	12,5	0,30	48	apricot	4,30
10533	9,0	15,5	0,50	48	apricot	5,30
	Ø cm	↑ cm	ltr.	VE	Farbe / Colour	€/ pc.
10534	7,0	9,5	0,15	48	green	3,20
10535	8,0	12,5	0,30	48	green	4,30
10536	9,0	15,5	0,50	48	green	5,30



**UNZERBRECHLICH**  
UNBREAKABLE



**3 SIZES**  
**5 COLOURS**



Farbe french grey  
colour french grey

stapelbar  
stackable

10509

Trinkglas „BEACH“  
drinking glass  
vaso  
verre



vielseitig einsetzbar, robustes, unzerbrechliches Material  
can be used in versatile ways, a solide and unbreakable material  
se pueden utilizar de muchas maneras diferentes, material sólido e irrompible  
peuvent être utilisés de différentes façons, matériau robuste et incassable

	Ø cm	↑ cm	ltr.	VE	Farbe / Colour	€/ pc.
10509	8,5	13,5	0,30	48	french grey	4,50
10505	8,5	13,5	0,30	48	white	4,30



# MOSCOW MULE



## Flaschenkühler „MOSCOW MULE“

bottle cooler  
enfriador de botellas  
rafraîchisseur de bouteilles

**Edelstahl-Flaschenkühler, Antik-Kupfer-Look**  
stainless steel cooler, copper antique look  
enfriador de acero inoxidable, cobre estilo antigua  
rafraîchisseur en acier inox, cuivre style antique



	Ø cm	↑ cm	ltr.	Farbe / Colour	€
93330	20	21	5	copper-antique-hammered	54,00



## Becher „MOSCOW MULE“, 2er-Set

barrel copper mug, 2 pcs.  
taza, set de 2  
gobelet, set de 2

**Edelstahlbecher, Antik-Kupfer-Look**  
stainless steel cup, copper antique look  
taza de acero inoxidable, cobre estilo antiguo  
gobelet en acier inox, cuivre style antique



	Ø cm	↑ cm	ltr.	Farbe / Colour	€ / set
93367	9	10	0,5	copper-antique-hammered	23,20



## Becher „MOSCOW MULE“

barrel mug  
taza  
gobelet

**Edelstahlbecher, Antik-Edelstahl-Look**  
stainless steel cup, stainless steel antique look  
taza de acero inoxidable, acero estilo antiguo  
gobelet en acier inox, acier style antique



	Ø cm	↑ cm	ltr.	Farbe / Colour	€
93346	9	10	0,5	stainless-antique-hammered	11,80



**Becher „MOSCOW MULE“**

barrel mug

taza

gobelet

**Edelstahlbecher, Antik-Edelstahl-Look**

stainless steel cup, stainless antique look

taza de acero inoxidable, acero estilo antiguo

gobelet en acier inox, acier style antique



	∅ cm	↑ cm	ltr.	Farbe / Colour	€
93345	9	9	0,45	■ stainless-antique	11,80



**Becher „MOSCOW MULE“**

barrel copper mug

taza

gobelet

**Edelstahlbecher, Antik-Kupfer-Look**

stainless steel cup, copper antique look

taza de acero inoxidable, cobre estilo antiguo

gobelet en acier inox, cuivre style antique

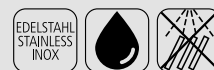

	∅ cm	↑ cm	ltr.	Farbe / Colour	€
93322	9	9	0,45	■ copper-antique	11,80



**Becher „MOSCOW MULE“**

barrel copper mug

taza

gobelet

**Edelstahlbecher, Kupfer-Look, hochglanzpoliert**

stainless steel cup, copper look, mirror polished

taza de acero inoxidable, estilo cobre, pulido brillante

gobelet en acier inox, aspect cuivre, poli brillant

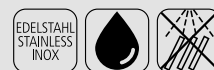

	∅ cm	↑ cm	ltr.	Farbe / Colour	€
93310	9	9	0,45	■ copper-look	11,80



**Becher „MOSCOW MULE“**

barrel copper mug

taza

gobelet

**Edelstahlbecher, Kupfer-Look, hochglanzpoliert**

stainless steel cup, copper look, mirror polished

taza de acero inoxidable, estilo cobre, pulido brillante

gobelet en acier inox, aspect cuivre, poli brillant



	∅ cm	↑ cm	ltr.	Farbe / Colour	€
93311	9	10	0,50	■ copper-hammered	11,80



**Becher „MOSCOW MULE“**

barrel copper mug

taza

gobelet

**Edelstahlbecher, Antik-Kupfer-Look**

stainless steel cup, copper look

taza de acero inoxidable, cobre estilo antiguo

gobelet en acier inox, cuivre style antique



	∅ cm	↑ cm	ltr.	Farbe / Colour	€
93323	9	10	0,50	■ copper-antique-hammered	11,80

## MOSCOW MULE



### Becher „MOSCOW MULE“

barrel mug  
taza  
gobelet

**Edelstahlbecher, Antik-Edelstahl-Look**  
stainless steel cup, stainless antique look  
taza de acero inoxidable, acero estilo antiguo  
gobelet en acier inox, acier style antique



	Ø cm	↑ cm	ltr.	Farbe / Colour		€
93333	9,5	10	0,50		stainless-antique	11,80



### Becher „MOSCOW MULE“

barrel copper mug  
taza  
gobelet

**Edelstahlbecher, Antik-Kupfer-Look**  
stainless steel cup, copper antique look  
taza de acero inoxidable, cobre estilo antiguo  
gobelet en acier inox, cuivre style antique



	Ø cm	↑ cm	ltr.	Farbe / Colour		€
93331	9,5	10	0,50		copper-antique	11,80

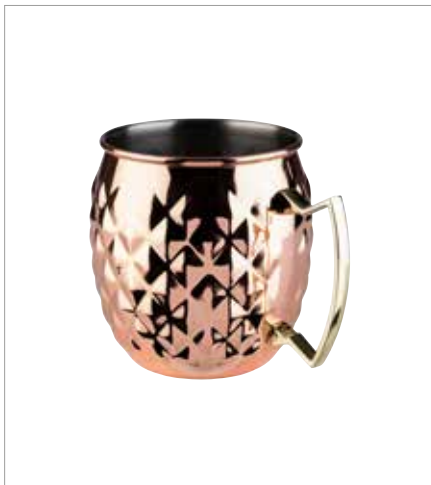

### Becher „MOSCOW MULE“

barrel copper mug  
taza  
gobelet

**Edelstahlbecher, Kupfer-Look, hochglanzpoliert**  
stainless steel cup, copper look, mirror polished  
taza de acero inoxidable, estilo cobre, pulido brillante  
gobelet en acier inox, aspect cuivre, poli brillant



	Ø cm	↑ cm	ltr.	Farbe / Colour		€
93332	9,5	10	0,50		copper-look	11,80



### Becher „BEER MUG“

barrel mug  
taza  
gobelet

	Ø cm	↑ cm	ltr.	Farbe / Colour		€
93364	8,5	13	0,50		copper-antique	15,40
93365	8,5	13	0,50		stainless-antique	15,40





**Becher „COOL“**

barrel mug  
taza  
gobelet

**Edelstahlbecher, Antik-Edelstahl-Look**

stainless steel cup, stainless antique look  
taza de acero inoxidable, acero estilo antiguo  
gobelet en acier inox, acier style antique



	Ø cm	↑ cm	ltr.	Farbe / Colour		€
93373	7,5	10,5	0,35		stainless-antique	9,90



**Becher „COOL“**

barrel mug  
taza  
gobelet

**Edelstahlbecher, Kupfer-Look, hochglanzpoliert**

stainless steel cup, copper look, mirror polished  
taza de acero inoxidable, estilo cobre, pulido brillante  
gobelet en acier inox, aspect cuivre, poli brillant



	Ø cm	↑ cm	ltr.	Farbe / Colour		€
93371	7,5	10,5	0,35		copper-look	9,90



**Becher „COOL“**

barrel mug  
taza  
gobelet

**Edelstahlbecher, Gunmetal-Look, hochglanzpoliert**

stainless steel cup, gunmetal look, mirror polished  
taza de acero inoxidable, estilo gunmetal, pulido brillante  
gobelet en acier inox, aspect gunmetal, poli brillant



	Ø cm	↑ cm	ltr.	Farbe / Colour		€
93372	7,5	10,5	0,35		gunmetal-look	9,90



**Becher „COOL“**

barrel mug  
taza  
gobelet

**Edelstahlbecher, Regenbogen-Look**

stainless steel cup, rainbow look  
taza de acero inoxidable, estilo arco iris  
gobelet en acier inox, look arc-en-ciel



	Ø cm	↑ cm	ltr.	Farbe / Colour		€
93374	7,5	10,5	0,35		rainbow-look	9,90



**Speedshaker / Trinkbecher**

speed shaker / drinking cup  
agitador rápido / vaso  
speedshaker / gobelet



	Ø cm	↑ cm	ltr.		€
93204	8,5	13	0,5		8,00

# JULEP MUGS



## Becher „JULEP MUG“ barrel mug taza gobelet



	Ø cm	↑ cm	ltr.	Farbe / Colour	€
93336	8	11,5	0,40	copper-antique-hammered	12,80
93337	8	11,5	0,40	copper-hammered	12,80
93338	8	11,5	0,40	stainless-antique-hammered	12,80



## Becher „JULEP MUG“ barrel mug taza gobelet



	Ø cm	↑ cm	ltr.	Farbe / Colour	€
93327	8,5	10	0,35	copper-antique	12,80
93328	8,5	10	0,35	copper-look	12,80
93329	8,5	10	0,35	stainless	12,80



## Snackspender snack dispenser dispensador de snacks distributeur de snacks



Behälter aus Glas, Schraubdeckel aus Edelstahl, Öffnung oval 3,5 x 2,5 cm  
glass container, stainless steel screw cap, opening oval 3,5 x 2,5 cm  
recipiente de cristal, tapón de rosca de acero inoxidable, apertura ovalada 3,5 x 2,5 cm  
récipient en verre, couvercle à visser en acier inox, ouverture ovale 3,5 x 2,5 cm

	Ø cm	↑ cm	ltr.	Farbe / Colour	€
40516	8,5	15,5	0,35	gold-look	8,40
40517	8,5	15,5	0,35	gunmetal-look	8,40





**mit Deckel**  
with lid  
**ohne Strohalm**  
without straw

**Becher „PINEAPPLE“**

barrel mug  
taza  
gobelet

**Glasbecher mit Edelstahl Deckel**

glass cup with stainless steel lid  
taza de cristal con tapa en acero inoxidable  
gobelet en verre avec couvercle en acier inox



	Ø cm	↑ cm	ltr.	€
93375	8,5	17,5	0,35	18,50



**mit Deckel**  
with lid  
**ohne Strohalm**  
without straw

**Becher „PINEAPPLE“**

barrel mug  
taza  
gobelet

**Edelstahlbecher, Kupfer-Look**

stainless steel cup, copper look  
taza de acero inoxidable, cobre  
gobelet en acier inox, cuivre



	Ø cm	↑ cm	ltr.	Farbe / Colour	€
93334	9	19	0,5	 copper-look	22,90



**mit Deckel**  
with lid  
**ohne Strohalm**  
without straw

**Becher „PINEAPPLE“**

barrel mug  
taza  
gobelet

**Edelstahlbecher, Gold-Look**

stainless steel cup, gold look  
taza de acero inoxidable, dorada  
gobelet en acier inox, doré



	Ø cm	↑ cm	ltr.	Farbe / Colour	€
93335	9	19	0,5	 gold-look	22,90



93399

93400



**Gläserchiene**

glass rack  
rack de copas  
rack porte-verres

**aus 6 mm Draht, Metall verchromt, Wand- und Deckenmontage möglich**

6 mm chrome plated wire, can be mounted under a shelf or on the wall  
alambre cromado de 6 mm, puede instalarse bajo una estantería o en la pared  
fil chromé de 6 mm, à installer sous une étagère ou contre un mur



	cm	↑ cm	for glasses	Farbe / Colour	€
93398	29,5 x 32	6	12	 chrome	25,00
93399	29,5 x 32	6	12	 black	25,00
93400	45,0 x 32	6	20	 chrome	34,00

# SHAKERS



## Tin in tin Shaker

tin in tin shaker  
coctelera tin in tin  
shaker tin in tin

2-teiliges Set, Edelstahlbecher, mattiert

2 pieces, stainless steel cup, matt polished

set de 2, taza de acero, pulido mate

set de 2, gobelet en acier, poli mat



	Ø cm	↑ cm	ltr.	€
93203	9	27	0,7 / 0,5	16,00

Ersatztrinkbecher / spare drinking cup / vaso de recambio / gobelet de recharge

	Ø cm	↑ cm	ltr.	€
93204	8,5	13	0,5	8,00



## Boston Shaker

boston shaker  
coctelera boston  
shaker boston

2-teiliges Set: Becher, 700 ml + Glas, 400 ml

2 pcs.: beaker, 700 ml + glass, 400 ml

set de 2: vaso coctelero, 700 ml+ vaso vidrio 400 ml

set de 2: bol mélangeur, 700 ml + bol en verre 400 ml



	Ø cm	↑ cm	ltr.	Farbe / Colour	€
93140	9	30	0,7 / 0,4	stainless-steel	14,80
93350	9	30	0,7 / 0,4	stainless-antique	15,30

	Ø cm	↑ cm	ltr.	Farbe / Colour	€
93325	9	30	0,7 / 0,4	copper-antique	15,30
93201	9	30	0,7 / 0,4	copper-look	15,30

Ersatzglas / spare glass / vaso de recambio / verre de recharge

	Ø cm	↑ cm	ltr.	€
93138	8,5	14,5	0,4	9,30



## Boston Shaker

boston shaker  
coctelera boston  
shaker boston

2-teiliges Set: Becher, 700 ml, gummiert, rutschfest + Glas, 400 ml

2 pcs.: beaker, 700 ml, rubberized, anti-slip + glass, 400 ml

set de 2: vaso coctelero con goma exterior 700 ml + vaso de vidrio 400 ml

set de 2: bol mélangeur inox extérieur plastifié couleur 700 ml + bol en verre 400 ml



	Ø cm	↑ cm	ltr.	Farbe / Colour	€
93139	9	30	0,7		15,20

36010  
500 ml36011  
700 ml**Shaker „CLASSIC“**shaker  
coctelera  
shaker**3-teiliges Set: Edelstahlbecher, Siebaufsatz, Deckel, hochglanzpoliert**

3 pieces: stainless steel mug, strainer, lid, mirror polished

set de 3: taza de acero inoxidable, colador, tapa, pulido brillante

set de 3: gobelet en acier inox, tamis, couvercle, poli brillant

	Ø cm	↑ cm	ltr.	€
36010	8,5	20	0,5	15,00
36011	9,0	23	0,7	19,20

93211  
500 ml93212  
700 ml**Shaker „CLASSIC“**shaker  
coctelera  
shaker**3-teiliges Set: Edelstahlbecher, Siebaufsatz, Deckel, Kupfer-Look, hochglanzpoliert**

3 pieces: stainless steel mug, strainer, lid, copper look, mirror polished

set de 3: taza de acero inoxidable, colador, tapa, cobre, pulido brillante

set de 3: gobelet en acier inox, tamis, couvercle, cuivre, poli brillant

	Ø cm	↑ cm	ltr.	Farbe / Colour	€
93211	8,5	20	0,5	copper-look	17,30
93212	9,0	23	0,7	copper-look	22,10

93366  
700 ml93326  
700 ml**Shaker „CLASSIC“**shaker  
coctelera  
shaker**3-teiliges Set: Edelstahlbecher, Siebaufsatz, Deckel**

3 pieces: stainless steel mug, strainer, lid

set de 3: taza de acero inoxidable, colador, tapa

set de 3: gobelet en acier inox, tamis, couvercle

	Ø cm	↑ cm	ltr.	Farbe / Colour	€
93366	9,0	23	0,7	stainless-antique	21,60
93326	9,0	23	0,7	copper-antique	21,60



700 ml

**Parisian Shaker**shaker  
coctelera  
shaker**2-teiliges Set, Edelstahlbecher, mattiert**

2 pieces, stainless steel cup, matt polished

set de 2, taza de acero, pulido mate

set de 2, gobelet en acier, poli mat

	Ø cm	↑ cm	ltr.	€
93179	9,5	24	0,7	17,90



# JIGGERS



**Barmaß**  
jigger  
medidor jigger  
mesure double jigger



schnelles und genaues Abmessen von Spirituosen, mit Füllstrich  
quick and exact measuring of spirits, with fill line  
medida rápida y exacta de licores, con línea de llenado  
mesure exact et rapide des spiritueux, avec ligne de remplissage

	Ø cm	↑ cm	ltr.	Farbe / Colour		€
93351	4,5	9	2 / 4		stainless-steel-polished	7,60
93354	4,5	9	2 / 4		stainless-antique	8,70



**Barmaß**  
jigger  
medidor jigger  
mesure double jigger



schnelles und genaues Abmessen von Spirituosen, mit Füllstrich  
quick and exact measuring of spirits, with fill line  
medida rápida y exacta de licores, con línea de llenado  
mesure exact et rapide des spiritueux, avec ligne de remplissage

	Ø cm	↑ cm	ltr.	Farbe / Colour		€
93353	4,5	9	2 / 4		copper-look	10,90
93352	4,5	9	2 / 4		copper-antique	10,90



**Barmaß**  
jigger  
medidor jigger  
mesure double jigger



schnelles und genaues Abmessen von Spirituosen, mit Füllstrich  
quick and exact measuring of spirits, with fill line  
medida rápida y exacta de licores, con línea de llenado  
mesure exact et rapide des spiritueux, avec ligne de remplissage

	Ø cm	↑ cm	ltr.	Farbe / Colour		€
93164	4,5	9	1,5 / 2,5 / 3,5 / 5		stainless-steel-polished	8,70
93355	4,0	11	1,5 / 2,5 / 3,5 / 5		stainless-antique	9,80



**Barmaß**  
jigger  
medidor jigger  
mesure double jigger



schnelles und genaues Abmessen von Spirituosen, mit Füllstrich  
quick and exact measuring of spirits, with fill line  
medida rápida y exacta de licores, con línea de llenado  
mesure exact et rapide des spiritueux, avec ligne de remplissage

	Ø cm	↑ cm	ltr.	Farbe / Colour		€
93165	4,5	9	1,5 / 2,5 / 3,5 / 5		copper-look	13,10
93324	4,0	11	1,5 / 2,5 / 3,5 / 5		copper-antique	13,10



**Barmaß**

jigger  
medidor jigger  
measure double jigger



hochglanzpoliert, schnelles und genaues Abmessen von Spirituosen, mit Füllstrich  
mirror polished, quick and exact measuring of spirits, with fill line  
pulido brillante, medida rápida y exacta de licores, con línea de llenado  
poli miroir, mesure exact et rapide des spiritueux, avec ligne de remplissage

	∅ cm	↑ cm	cl.	€
93356	5	9	1 / 1,5 / 2 / 3 / 4 / 6	13,10



**Barmaß**

jigger  
medidor jigger  
measure double jigger



hochglanzpoliert, schnelles und genaues Abmessen von Spirituosen, mit Füllstrich  
mirror polished, quick and exact measuring of spirits, with fill line  
pulido brillante, medida rápida y exacta de licores, con línea de llenado  
poli miroir, mesure exact et rapide des spiritueux, avec ligne de remplissage

	∅ cm	↑ cm	cl.	€
93357	3,5	7,5	3 / 5	5,50



**Barmaß**

jigger  
medidor jigger  
measure double jigger



hochglanzpoliert, schnelles und genaues Abmessen von Spirituosen, mit Füllstrich  
mirror polished, quick and exact measuring of spirits, with fill line  
pulido brillante, medida rápida y exacta de licores, con línea de llenado  
poli miroir, mesure exact et rapide des spiritueux, avec ligne de remplissage

	∅ cm	↑ cm	cl.	€
93121	4,0 / 3,5	8,5	2 / 4	5,50
93112	4,5 / 4,0	8,5	2,5 / 5	5,90



**Barmaß**

jigger  
medidor jigger  
measure double jigger



hochglanzpoliert, schnelles und genaues Abmessen von Spirituosen, mit Füllstrich  
mirror polished, quick and exact measuring of spirits, with fill line  
pulido brillante, medida rápida y exacta de licores, con línea de llenado  
poli miroir, mesure exact et rapide des spiritueux, avec ligne de remplissage

	∅ cm	↑ cm	cl.	€
93120	4,5 / 3,5	7,0	2 / 4	5,10



**Barmaß**

jigger  
medidor jigger  
measure double jigger



hochglanzpoliert, schnelles und genaues Abmessen von Spirituosen, mit Füllstrich  
mirror polished, quick and exact measuring of spirits, with fill line  
pulido brillante, medida rápida y exacta de licores, con línea de llenado  
poli miroir, mesure exact et rapide des spiritueux, avec ligne de remplissage

	∅ cm	↑ cm	cl.	€
93116	6 / 5	6	2 / 4	4,70



# MUDDLERS



**Stößel**  
muddler  
mortero  
pilon muddler



**mit griffigem Ende, zum Auspressen von Früchten und Zerstoßen von Würfelzucker**  
with handy end, to press fruits or pound lump sugar  
con un acabado en relieve para exprimir frutas y machacar azucarillos  
avec relief grillagé pour presser les fruits ou le sucre en morceaux

	Ø cm	→ cm		Farbe / Colour	€
93358	3,5	20,5	stainless steel		7,20
93360	3,5	20,5	copper-look		9,20
93361	3,5	20,5	stainless-antique		9,20
93362	3,5	20,5	copper-antique		9,20



**Stößel**  
muddler  
mortero  
pilon muddler



**grober Stößel, zum Auspressen von Früchten und Zerstoßen von Würfelzucker**  
coarse notched, to press fruits or pound lump sugar  
mortero grueso con muescas para exprimir frutas y machacar azucarillos  
muddler grand format avec bout relief étoile pour presser les fruits ou le sucre en morceaux

	Ø cm	→ cm		Farbe / Colour	€
93181	2,5	21			4,20
93182	4	24			8,60



**Stößel**  
muddler  
mortero  
pilon muddler



**aus Buchenholz, mit griffigem Ende, zum Auspressen von Früchten und Zerstoßen von Würfelzucker**  
beech wood, with handy end, to press fruits or pound lump sugar  
madera de haya, acabado relieve para prensar frutas o azucar  
bois de hêtre, avec relief grillagé pour presser les fruits ou le sucre en morceaux

	Ø cm	→ cm		Farbe / Colour	€
93180	2,5	21			3,80

# BAR SPOONS

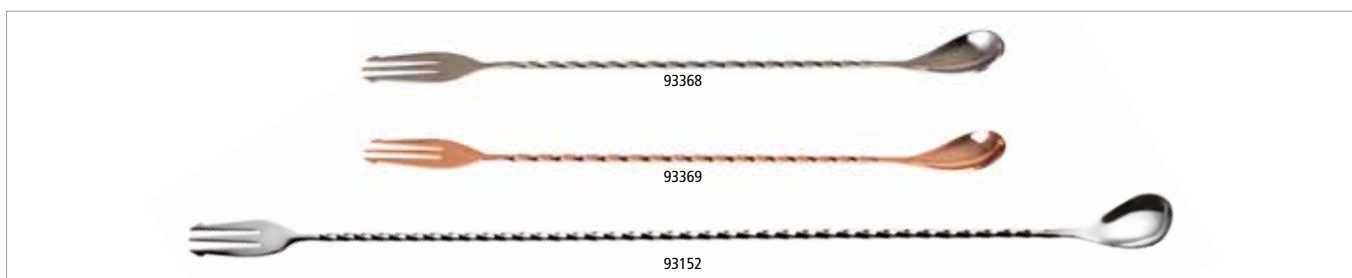

**Barlöffel / -gabel**  
bar spoon  
cucharilla de cóctel trident  
cuillère de bar trident



	→ cm	Farbe / Colour		€
93368	30		stainless steel	7,00
93369	30		copper-look	9,90
93152	50		stainless steel	8,00

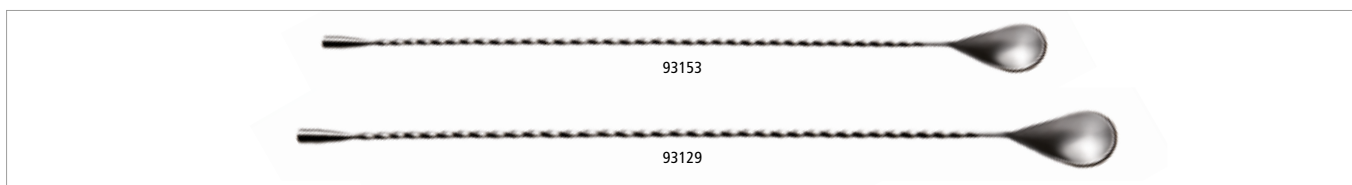

**Barlöffel**  
bar spoon  
cucharilla de cóctel  
cuillère à cocktail



	→ cm	Farbe / Colour		€
93153	40		stainless steel	6,20
93129	44		stainless steel	9,80



**Barlöffel**  
bar spoon  
cucharilla de cóctel  
cuillère à cocktail



	→ cm	Farbe / Colour		€
93134	27		stainless steel	5,90
93034	27		copper-look	8,60



# BAR STRAINERS



## Barsieb

bar strainer  
colador de cóctel  
tamis cocktail



Spiralfeder hält Eiswürfel beim Abseihen zurück, Feder kann zur Reinigung entnommen werden, passend für alle Gläser und Shaker

coil spring keeps ice cubes in shaker, spring can be taken off for cleaning, suitable for all glasses and shakers

con muelle para mantener los cubitos en la coctelera, el muelle se desmonta para limpiar, se adapta a todos los tipos de vasos y cocteleras

avec ressort pour garder les glaçons dans le shaker, ressort démontable pour lavage, s'adapte à tous types de verres mélangeurs et shakers

	Ø cm	Griff / handle cm	Farbe / Colour		€
93347	9	9		copper-antique	13,10
93348	9	9		copper-look	13,10
93349	9	9		stainless-antique	13,10
93312	9	9		stainless steel	11,40



Einhandgebrauch  
single-handed use



## Barsieb

bar strainer  
colador de cóctel  
tamis cocktail



hochglanzpoliert, Spiralfeder hält Eiswürfel beim Abseihen zurück, Feder kann zur Reinigung entnommen werden, passend für alle Gläser und Shaker

mirror polished, coil spring keeps ice cubes in shaker, spring can be taken off for cleaning, suitable for all glasses and shakers

pulido brillante, con muelle para mantener los cubitos en la coctelera, el muelle se desmonta para limpiar, se adapta a todos los tipos de vasos y cocteleras

poli brillant, avec ressort pour garder les glaçons dans le shaker, ressort démontable pour lavage, s'adapte à tous types de verres mélangeurs et shakers

	Ø cm	Griff / handle cm	€
93300	8	6	5,50



## Julep Barsieb „PRO“

julep strainer  
colador de cóctel  
tamis cocktail



hochglanzpoliert, Einhandgebrauch

mirror polished, single-handed use

pulido brillante, uso con una sola mano

poli brillant, utilisation d'une seule main



	Ø cm	Griff / handle cm	€
93313	7,5	9	9,80





**Barsieb**  
bar strainer  
colador de cóctel  
tamis cocktail



	Ø cm	↑ cm	Griff / handle cm	€
93318	8,5	5	11,5	4,50



**Schneidebrett „BAR“**  
cutting board  
table de corte  
planche à découper



**HDPE, mit Safrinne, mit Antirutschfüßchen**  
HDPE, with juice groove and non-slip feet  
HDPE, con ranura para líquidos y pies antideslizantes  
HDPE, avec rigole et pieds antidérapants

	cm	↑ cm	€
93306	30 x 20	2	26,80
93307	50 x 30	2	36,00



**Cocktailmesser „TOOLTIME“**  
bar knife  
cuchillo para cóctel  
couteau cocktail



**mit 2 Zinken zum Aufspießen von Zitrusseiben**  
with 2 prongs to pick up slices of lemon  
con 2 dientes para pinchar las rodajas de limón, etc.  
avec 2 dents pour les rondelles de citron et autres décorations

	→ cm	€
88846	21	4,80



**Dekoriermesser „TOOLTIME“**  
decorating knife „cannelé“  
cuchillo acanalador  
couteau canneléur



**gezahnte Klinge aus geschärftem Edelstahl**  
serrated sharpened blade, stainless steel  
hoja de sierra afilada, acero inoxidable  
lame inox microdentée

	→ cm	€
88843	19	5,90



**Zutatenbehälter**  
condiment holder  
dispensador de especias  
boîte à fruits et ingrédients



**500 ml Inhalt pro Fach, 6 Fächer, inklusive Deckel (gefrostet) zur Lagerung**  
6 chambers á 500 ml, including lid for storing  
6 compartimentos de 500 ml., incluye tapa para el almacenaje  
6 compartiments de 500 ml chacun, avec couvercle pour le stockage

	cm	↑ cm	€
93171	50 x 16	10	23,50

**Ersatzbehälter / replacement container / recipiente de recambio / récipient de remplacement**

	cm	↑ cm	fits to	€
93176	14 x 7,5	7,5	93171	2,00

## DRIP MATS



### Bar Caddy

bar caddy  
organizador de bar  
organisateur „bar caddy“



**Ordnungshilfe für Trinkhalme, Rührer, Servietten, Streichhölzer, etc.**  
to organize straws, stirrers, napkins, matches, etc.  
para organizar pajitas, cucharillas, servilletas, cerillas, etc.  
pour bien organiser les pailles, agitateurs, cuillers, serviettes et autres accessoires

	cm	↑ cm	€
93174	24 x 15	11	8,80



### Glasumrander

glass rimmer  
ribeteador de vasos  
bordeur à verres „rimmer“



**Schwamm für Limettensaft, 2 Fächer für Zucker und Salz**  
with sponge for lime juice, 2 cases for sugar and salt  
con esponja para zumo de lima, 2 compartimentos para azucar y sal  
avec éponge et 2 compartiments pour sucre et sel

	cm	€
93175	20 x 7,5	10,40



### Barmatte

drip mat  
tapete escurridor  
tapis de bar



**aus weichem Kunststoff, zum Abtropfen von Gläsern etc.**  
soft plastic, to store and drain glasses  
plástico blando para escurrir vasos  
plastique souple, pour l'égouttage des verres

	cm	↑ cm	Farbe / Colour	€
93168	60 x 8	1	mit Vertiefung	10,00
93166	30 x 15	1	ohne Vertiefung	7,60
93173	52 x 8	1	ohne Vertiefung	9,40
93169	60 x 8	1	ohne Vertiefung	10,00
93167	45 x 31	1	ohne Vertiefung	20,60

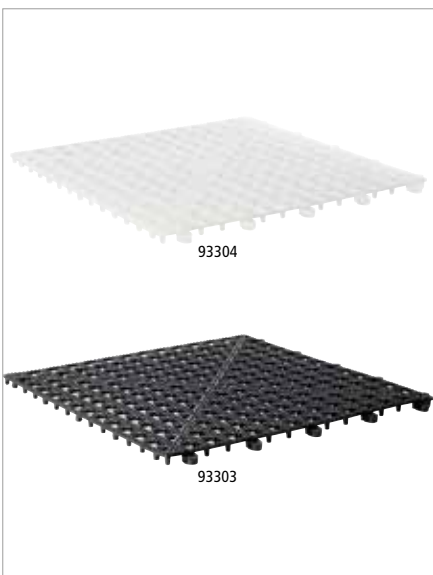

### Abtropfmatte

drip mat  
esterilla escurridora  
tapis égouttoir



**erweiterbar durch Klick-Verbindung**  
expandable  
las placas de fijan con clips  
avec clips de fixation

	cm	↑ cm	Farbe / Colour	€
93304	33 x 33	1,5	light blue	6,40
93303	33 x 33	1,5	black	6,40





# STRAWS



## Trinkhalme 11er Set

straws, 11 pcs. set  
pajas, set de 11 pz.  
pailles, set de 11 pc.



11-teiliges Set: 10 Trinkhalme aus Edelstahl + Reinigungsbürste

11 pcs. set: 10 drinking straws made of stainless steel + cleaning brush

set de 11: 10 pajas de acero inoxidable + cepillo de limpieza

set de 11: 10 pailles en acier inox + brosse de nettoyage

	Ø mm	→ cm	Farbe / Colour	€ / set
93391	8	15,0		copper-look 11,40
93392	8	15,0		gunmetal-look 11,40
93393	8	15,0		rainbow-look 11,40
93380	6	21,5		copper-look 12,40
93381	6	21,5		gunmetal-look 12,40
93382	6	21,5		rainbow-look 12,40
93383	8	21,5		copper-look 13,20
93384	8	21,5		gunmetal-look 13,20
93385	8	21,5		rainbow-look 13,20

Ersatzbürste / replacement brush / cepillo de recambio / brosse de rechange

	Ø mm	→ cm	€
93395	8	15	1,30
93386	8	20	2,60



## Trinkhalme 7er Set

straws, 7 pcs. set  
pajas, set de 7 pz.  
pailles, set de 7 pc.



	Ø mm	→ cm	pcs.	€ / set
93394	10	15	7	7,00
93390	10	21	7	8,00



## ICE BUCKETS



**Eisbox**  
icebox  
cubitera  
seau à glaçons



**Innenbehälter dient als Tropfeinsatz, hält die Eiswürfel bis zu 5 Stunden in ihrer Form**  
inner container serves as drainer, ice bucket keeps the ice cubes in shape for up to 5 hours  
contenedor interior sirve como inserto de goteo, mantiene los cubitos de hielo en forma hasta 5 horas  
réceptif intérieur sert d'égouttoir, maintient les glaçons dans leur forme jusqu'à 5 heures

	cm	↑ cm	ltr.		€
93220	27 x 27	15	5	max. 300 ice cubes	49,00



**Eisbox**  
icebox  
cubitera  
seau à glaçons



**Innenbehälter dient als Tropfeinsatz, hält die Eiswürfel bis zu 5 Stunden in ihrer Form**  
inner container serves as drainer, ice bucket keeps the ice cubes in shape for up to 5 hours  
contenedor interior sirve como inserto de goteo, mantiene los cubitos de hielo en forma hasta 5 horas  
réceptif intérieur sert d'égouttoir, maintient les glaçons dans leur forme jusqu'à 5 heures

	cm	↑ cm	ltr.		€
93200	20 x 20	17	3,4	max. 150 ice cubes	33,00



**Eisbox**  
icebox  
cubitera  
seau à glaçons



**Innenbehälter dient als Tropfeinsatz, hält bis zu 5 Stunden die Eiswürfel in ihrer Form**  
inner container serves as drainer, keeps the ice cubes in shape for up to 5 hours  
contenedor interior sirve como inserto de goteo, mantiene los cubitos de hielo en forma hasta 5 horas  
réceptif intérieur sert d'égouttoir, maintient les glaçons dans leur forme jusqu'à 5 heures

	Ø cm	↑ cm	ltr.		€
36033	18,5	20	3	max. 150 ice cubes	43,80
36037	27	20	6	max. 300 ice cubes	57,00



**Eiseimer-Set mit Eiszange**  
ice bucket set with tongs  
cubitera clásica con pinza  
seau à glaçons classique avec pince



**für max. 45 Eiswürfel, hält die Eiswürfel bis zu 5 Stunden in ihrer Form**  
max. 45 ice cubes, keeps the ice cubes in shape for up to 5 hours  
para un máximo de 45 cubitos de hielo, mantiene los cubitos de hielo en forma hasta 5 horas  
pour max. 45 glaçons, maintient les glaçons dans leur forme jusqu'à 5 heures

	Ø cm	↑ cm	ltr.		€
36013	12	14	1		32,00



**3-teiliges Set**  
3 pcs.



36016 1,3 ltr.



36015 1,3 ltr.

**Eiseimer-Set mit Eiszange**

ice bucket set with tongs  
cubitera clásica con pinza  
seau à glaçons classique avec pince



mit Abtropfgitter, isolierter Kunststoffeinsatz, Zange lässt sich im Deckel verstauen,  
für max. 50 Eiswürfel, hält die Eiswürfel bis zu 5 Stunden in ihrer Form

with drainer, insulated plastic insert, tongs can be stored in the lid,  
for max. 50 ice cubes, keeps the ice cubes in shape for up to 5 hours

con escurridor, inserto de plástico aislado, la pinza se puede guardar en la tapa, para un máxi-  
mo de 50 cubitos de hielo, mantiene los cubitos de hielo en forma hasta 5 horas

avec égouttoir, insert en plastique isolé, la pince peut être rangée dans le couvercle, pour max.  
50 glaçons, maintient les glaçons dans leur forme jusqu'à 5 heures

	Ø cm	↑ cm	ltr.	Farbe / Colour	€
36016 <small>NEW</small>	14	22	1,3		30,00
36015	14	22	1,3		30,00



**Eiszerkleinerer**

Ice crusher  
picadora de hielo  
broyeur à glaçons



glasklar, mit Edelstahl-Messer

clear, stainless steel cutters  
cuchillas de acero inoxidable  
couteaux inox



	cm	↑ cm	€
36017	12 x 12	24	18,10

**Eisschaufel**

ice scoop  
pala de hielo  
pelle à glaçons



	cm	→ cm	ltr.	€
93192	10 x 6	29	0,7	8,90

**Eisschaufel**

ice scoop  
pala de hielo  
pelle à glaçons



gelocht, ideal zum Befüllen von schlanken Gläsern

perforated, ideal to fill narrow glasses

perforada, ideal para llenar vasos estrechos

perforée, idéale pour verser les glaçons dans des verres étroits

	Ø cm	→ cm	€
93191	5	19,5	7,50

# ICE CUBE MAKERS



**Eiswürfel | ice cube**  
4 x 4 x 4 cm

## Eiswürfelform mit Deckel, 2er Set

ice cube maker with lid, 2 pcs.  
molde para cubitos de hielo con tapa, set de 2  
moule à glaçons avec couvercle, set de 2

**2 Eiswürfelformen für je 9 Eiswürfel**

2 ice cube moulds for 9 ice cubes each

2 moldes de cubitos de hielo para 9 cubitos cada uno

2 moules à glaçons pour 9 glaçons chacun



	cm	↑ cm	ice cubes	pcs.	€/ set
36102	15,5 x 15,5	5,5	4 x 4 x 4	2	17,00



Die Eiswürfel lassen sich leicht auslösen  
the ice cubes are easy to release

**Eiswürfel | ice cube**  
4 x 2,5 x 3 cm

## Eiswürfelform mit Deckel, 2er Set

ice cube maker with lid, 2 pcs.  
molde para cubitos de hielo con tapa, set de 2  
moule à glaçons avec couvercle, set de 2

**2 Eiswürfelformen für je 21 Eiswürfel**

2 ice cube moulds for 21 ice cubes each

2 moldes de cubitos de hielo para 21 cubitos cada uno

2 moules à glaçons pour 21 glaçons chacun



	cm	↑ cm	ice cubes	pcs.	€/ set
36103	25 x 15	4	4 x 2,5 x 3	2	12,00



**Eiskugel | ice ball**  
Ø 6 cm

## Eiskugelformer

ice ball former  
molde de cubitos de hielo esféricos  
moule à glaçons en boules

**2-teilig, 3 Kugeln à 100 ml, einfach mit Wasser füllen und gefrieren lassen**

3 bowls à 100 ml, simply fill with water and allow to freeze

3 bolas de 100 ml, simplemente llenar con agua y dejar congelar

3 boules à 100 ml, simplement remplir avec de l'eau et mettre à congeler



	cm	↑ cm	ice balls	€
12990	23,5 x 8,5	6,5	Ø 6	11,00



**Eiszange**

ice tongs  
pinzas para hielo  
pince de la glace

**hochglanzpoliert, mit Befestigungsclip**

mirror polished, with fastening clip  
pulido brillante, con clip de fijación  
poli brillant, avec clip de fixation



	→ cm	Farbe / Colour	€
75853	20	stainless steel	4,60
75854	20	copper-look	5,00
75855	20	gunmetal-look	5,00



Zange kann an einer Schale befestigt werden  
tongs can be attached to a bowl

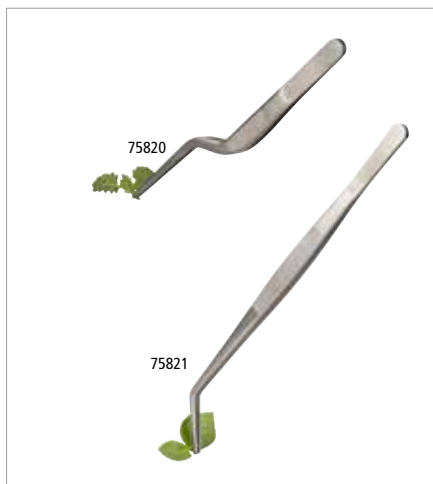

**Pinzettenzange**

fine tongs / tweezer  
pinza de emplatar  
pince à dresser

**hochglanzpoliert, geriffelte Grifffläche, schwere Qualität**

mirror polished, ribbed handle, heavy gauge  
pulido brillante, mango cómodo ranurado, alta calidad  
poli brillant, manche rainuré antiglisse, qualité extra



	→ cm	€
75820	16	6,60
75821	30	9,90



**Eiszange**

ice cube tongs  
pinza para cubitos de hielo  
pince à glaçons

**hochglanzpoliert, fugenlos**

mirror polished, seamless  
pulido brillante, de una sola pieza  
poli brillant, d'une seule pièce



	cm	→ cm	€
75805	5 x 2	17,5	2,40



**Eiszange**

ice tongs  
pinza para cubitos de hielo  
pince à glaçons

**matt poliert, mit griffigem Ende, ideal für Eiswürfel und Obstscheiben**

matt polished, with handy end, ideal for ice cubes and fruit slices  
pulido mate, forma ergonómica ideal para cubitos de hielo y láminas de fruta  
poli mat, forme ergonomique idéale pour glaçons et fruits tranchés



	cm	→ cm	€
93190	2 x 1,5	20	6,20

## POURERS



### Bitterflasche / Spritzflasche

bitter bottle / spray bottle  
botella / pulverizador licores  
bouteille/pisette p. liqueurs

**Ausgießer aus Kork, Edelstahl, ideal für Bitterliköre**

cork pouring spout, stainless steel, ideal for bitter liqueurs

pico de corcho, acero inox, ideal para licores amargos

bec verseur liège, acier inox, idéal pour les liqueurs amères



	cm	↑ cm	ltr.	€
93359	5 x 5	13	0,1	6,40



### Rührglas mit Lippe

mixing glass with lip  
vaso mezclador vertedor con pico  
verre mélangeur avec bec verseur

**schwere Qualität**

heavy quality

alta calidad

qualité renforcée



	Ø cm	↑ cm	ltr.	€
93141	9	16	0,5	11,40
93101	11,5	19	1,0	11,40



### Dosier- & Vorratsflasche

pouring container  
botella „store & pour“  
bouteille „store & pour“



**4-teilig: Behälter + Flaschenhals + Schraubdeckel + Ausgießer Ø 11 mm mit Luftzufuhr für gezieltes Ausgießen, zum Dosieren und Aufbewahren**

4 pcs. set: for storage, mixing and serving drinks, nozzle Ø 11 mm

set de 4 piezas: para almacenar y servir mezclas y bebidas, agujero de Ø 11 mm

se compose de 4 pièces: idéal pour servir et pour conserver les boissons, embout Ø 11 mm

	Ø cm	↑ cm	ltr.	Farbe / Colour	€
93144	9	33	0,85		5,90
93145	9	33	0,85		5,90
93146	9	33	0,85		5,90
93147	9	33	0,85		5,90
93148	9	33	0,85		5,90



abnehmbarer Boden dient als Deckel  
removable bottom serves as a lid





**Permanent-Ausgießer, 6er Set**  
 free flow pourer, 6 pcs.  
 vertedor continuos set 6 piezas  
 set de 6 bouchons verseurs continus



	↑ cm	pcs.	€ / set
93110	11	6	14,00



**Permanent-Ausgießer, 6er Set**  
 free flow pourer, 6 pcs.  
 vertedor continuos set 6 piezas  
 set de 6 bouchons verseurs continus



	↑ cm	pcs.	€ / set
93114	8	6	13,40



**Sekt-Verschluss, 2er Set**  
 stopper, 2 pcs.  
 set de 2 taponos  
 set de 2 bouchons



**matt poliert, innen Gummi Arabicum**  
 matt polished, inside rubber arabicum, with inscription  
 pulido mate, interior goma arábica con inscripción  
 poli maté, intérieur gomme arabique

	Ø cm	↑ cm	pcs.	€ / set
93160	4	5,5	2	8,90



**Permanent-Ausgießer, 6er Set**  
 free flow pourer, 6 pcs.  
 vertedor continuos set 6 piezas  
 set de 6 bouchons verseurs continus



**à 2 Stück: blau, rot, gelb**  
 2 pcs of each colour: blue, red, yellow  
 2 piezas de cada color: azul, rojo, amarillo  
 2 par couleur: bleu, rouge, jaune

	Ø cm	↑ cm	pcs.	€ / set
93111	3	7,5	6	5,60



**Reinigungsbürste für Ausgießer**  
 pourer cleaning brush  
 cepillo de limpieza para picos vertedores  
 brosse lave-bouchons doseurs



	→ cm	€
93102	16,5	2,80



**Staubkappen, 2er Set**  
 dust & fly cap, 2 pcs.  
 tapón antipolvo  
 bouchon anti-poussières et anti-insectes  
 schützt vor Staub und Insekten  
 protects for dust and insects  
 para proteger de la suciedad e insectos  
 pour protéger de la poussière et des insectes



	Ø cm	↑ cm	Farbe / Colour	pcs.	€ / set
93161	4	8	■	2	4,90



**Kellnermesser „PROFI“**

waiter's corkscrew  
sacacorchos de camarero  
tire-bouchons



leichtgängige Teflon-Spirale, mehrstufige Klapphebelfunktion, am Fuß angebrachtes Messer  
easy moving teflon coil, 2-stage opening system, knife at the bottom end  
mecha de teflón, sistema de apertura en 2 golpes, con cuchillo en la parte superior  
mèche téflon, ouverture en 2 étapes, couteau dans la partie supérieure

	→ cm	€
93302	11,5	10,80



**Kellnermesser**

waiter's corkscrew  
sacacorchos de camarero  
tire-bouchons



leichtgängige Teflon-Spirale, mehrstufige Klapphebelfunktion, am Kopf angebrachtes Messer  
easy moving teflon coil, 2-stage opening system, knife at the top end  
mecha de teflón, sistema de apertura en 2 golpes, con cuchilla en la parte superior  
mèche téflon, ouverture en 2 étapes, couteau dans la partie supérieure

	→ cm	€
93301	12	5,20



**Kellner-Flaschenöffner**

waiter's barblade  
abridor camarero  
décapsuleur



magnetisch, schwarz / magnetic, black / magnético, negro / magnétique, noir

	→ cm	Farbe / Colour	€
93377	18	■	4,20



**Kellner-Flaschenöffner**

waiter's barblade  
abridor camarero  
décapsuleur



magnetisch, matt poliert / magnetic, matt polished / magnético, pulido mate / magnétique, poli mat

	→ cm	Farbe / Colour	€
93122	18	■	3,70

matt poliert / matt polished / pulido mate / poli mat

	→ cm	Farbe / Colour	€
00617	13,5	■	6,10



**Kellner-Flaschenöffner**

waiter's barblade  
abridor camarero  
décapsuleur



magnetisch, mit Gummierung

magnetic, with rubber coating

magnético, con revestimiento de goma

magnétique, avec revêtement en caoutchouc

	→ cm	€
93125	11	4,30



**Kronkorkenöffner**

bottle cap opener  
abridor de chapas de pared  
décapsuleur mural



für die Wandmontage, aus massivem Metall, inklusive 2 Schrauben  
for wall fastening, massive metal, including 2 screws  
para fijación en la pared, metal macizo, incluye 2 tornillos  
massif, à fixer au mur, y compris 2 vis

	cm	↑ cm	€
93124	7 x 8	3	10,40

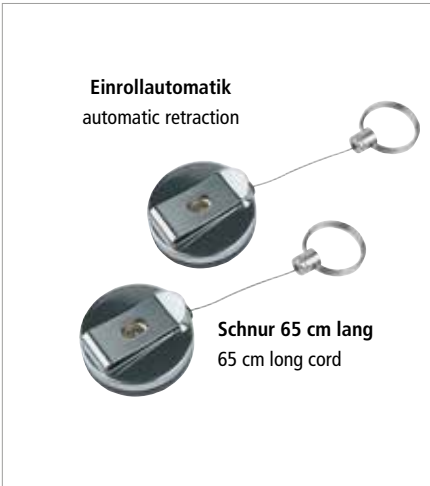

Einrollautomatik  
automatic retraction

**Schlüsselschnur, 2er Set**

key cord, 2 pcs.  
llavero enrollable  
porte-clés avec câble à enroulement



Befestigung mit Klammer am Gürtel, starke Rückzugfeder  
to fix at waistbelt, strong pull-back spring  
se fija en el cinturón, cable retrocede automáticamente  
à fixer à la ceinture, enroulage automatique

	Ø cm	↑ cm	€
93170	4	2	7,60



00621

**Flaschenkühler „CONFERENCE“**

conference bottle cooler  
enfriador múltiple  
rafraîchisseur



inkl. Kühllakku, Flaschenöffner, Kronkorkenschale,  
mit 6 Öffnungen Ø 6,7 cm für 0,25 - 0,5 Liter-Flaschen  
incl. bottle cooler, bottle opener, small cap bowl,  
with 6 holes Ø 6,7 cm for 0,25 to 0,5 liter bottle  
con acumulador de frío, abridor, recuperador de chapas,  
6 plazas Ø 6,7 cm, para botellas de 25 a 50 cl  
avec accumulateur de froid, décapsuleur, bol récupérateur  
de capsules, 6 places Ø 6,7 cm, pour bouteilles de 25 à 50 cl

	Ø cm	↑ cm	Farbe / Colour	€
00620	23	15	White	54,00
00621	23	15	Black	54,00

**Kühllakku / cooler / acumulador de frío / accumulateur de froid**

	Ø cm	↑ cm	Farbe / Colour	€
00615	7,5	11,5	Black	10,50

**Kronkorkenschale / cap bowl / cuenco para chapas / bol récupérateur de capsules**

	Ø cm	↑ cm	Farbe / Colour	€
00618	6,5	3	White	2,50
00619	6,5	3	Black	2,50

**Flaschenöffner / bottle opener / abridor / décapsuleur**

	Ø cm	→ cm	€
00617	1	13,5	6,10



# LIME AND LEMON SQUEEZERS



**Limetten- / Zitronenpresse**  
lime- / lemon squeezer  
exprimidor de limón / lima  
presse citron



**2 Pressringe für Zitrone und Limette**  
2 squeezing rings for lemon and lime  
2 anillos exprimidores para limón y lima  
2 anneaux à presser pour le citron et le lime

	cm	↑ cm	€
93214	21 x 7	5	14,60



**Limettenpresse**  
lime squeezer  
prensa de limón  
presse citron



	cm	↑ cm	€
93189	21 x 7	5	11,40



**Zitruspresse**  
citrus squeezer  
exprimidor cítricos  
presse-citron



**hochglanzpoliert, 2-teilig / mirror polished, 2 pcs. / pulido brillante, 2 piezas / poli brillant, 2 pièces**

	Ø cm	↑ cm	ltr.	€
71431	12 / 17	10,5	0,35	13,80

NEW **SAMOWAR**

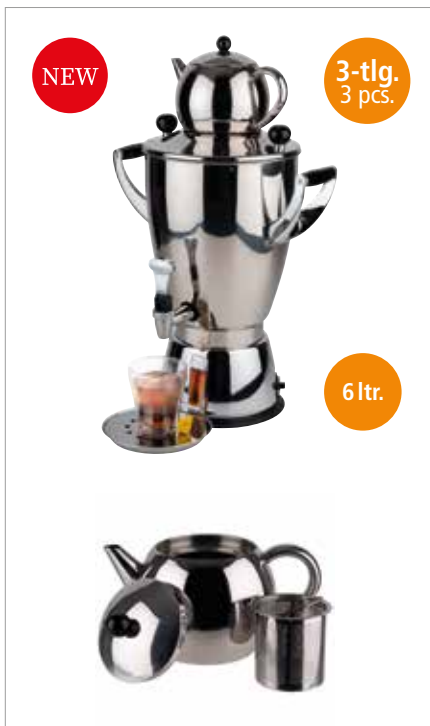

NEW

3-tlg.  
3 pcs.

6 ltr.

**Samovar**samovar  
samovar  
samovar**3-teiliges Set:**

- 1 Samovar, 230V, 50/60Hz, 1.800W (6 Liter)
- 1 Teekanne (1,1 Liter)
- 1 Tropfenschale

**3 pcs. set:**

- 1 samovar, 230V, 50/60Hz, 1.800W (6 ltr.)
- 1 teapot (1,1 ltr.)
- 1 drip tray

**set de 3:**

- 1 samovar, 230V, 50/60Hz, 1.800W (6 L.)
- 1 tetera (1,1 L.)
- 1 bandeja recogegotas

**set de 3:**

- 1 samovar, 230V, 50/60Hz, 1.800W (6 L.)
- 1 théière (1,1 L.)
- 1 bac ramasse-gouttes



	cm	↑ cm	ltr.	€
12315	35 x 21	58	6	540,00



NEW

3-tlg.  
3 pcs.

12 ltr.

**Samovar**samovar  
samovar  
samovar**3-teiliges Set:**

- 1 Samovar, 230V, 50/60Hz, 1.800W (12 Liter)
- 1 Teekanne (1,3 Liter)
- 1 Tropfenschale

**3 pcs. set:**

- 1 samovar, 230V, 50/60Hz, 1.800W (12 ltr.)
- 1 teapot (1,3 ltr.)
- 1 drip tray

**set de 3:**

- 1 samovar, 230V, 50/60Hz, 1.800W (12 L.)
- 1 tetera (1,3 L.)
- 1 bandeja recogegotas

**set de 3:**

- 1 samovar, 230V, 50/60Hz, 1.800W (12 L.)
- 1 théière (1,3 L.)
- 1 bac ramasse-gouttes



	cm	↑ cm	ltr.	€
12316	42 x 26	75	12	890,00

# TEAPOTS



## Teekanne „ASIA“

teapot  
tetera  
théière



aus Gusseisen, innen emailliert, abnehmbarer Deckel, mit Teesieb aus Edelstahl

made of cast iron, enamelled inside, removable lid, with tea strainer made of stainless steel  
hierro fundido, interior esmaltado, tapa extraíble, con colador de té de acero inoxidable  
en fonte, émaillé à l'intérieur, couvercle amovible, avec une passoire à thé en acier inox

	cm	↑ cm	ltr.	Farbe / Colour	€
10995	17 x 14	17	0,8		26,00
10996	17 x 14	17	0,8		26,00



## Teekanne „ASIA“

teapot  
tetera  
théière



aus Gusseisen, innen emailliert, abnehmbarer Deckel, mit Teesieb aus Edelstahl

made of cast iron, enamelled inside, removable lid, with tea strainer made of stainless steel  
hierro fundido, interior esmaltado, tapa extraíble, con colador de té de acero inoxidable  
en fonte, émaillé à l'intérieur, couvercle amovible, avec une passoire à thé en acier inox

	cm	↑ cm	ltr.	Farbe / Colour	€
10991	19,5 x 18	15	0,8		26,00
10992	19,5 x 18	15	0,8		26,00



## Teekanne „ASIA“

teapot  
tetera  
théière



aus Gusseisen, innen emailliert, mit abnehmbarem Deckel, ohne Teesieb aus Edelstahl  
made of cast iron, enamelled inside, with removable lid, without tea strainer made of stainless steel

hierro fundido, interior esmaltado, con tapa extraíble, sin colador de té de acero inoxidable  
en fonte, émaillé à l'intérieur, avec couvercle amovible, sans une passoire à thé en acier inox

	cm	↑ cm	ltr.	Farbe / Colour	€
10990	12,5 x 11	12,5	0,3		21,00

**Stövchen „ASIA“**

teapot warmer  
calentador de tetera  
chauffe-théière



**1-flammiges Stövchen aus Gusseisen mit abnehmbarem Deckel (Lieferung ohne Teelicht).**

1-flame cast iron warmer with removable lid (delivery without tealight).

calentador de tetera de hierro fundido con 1 quemador con tapa extraíble (se entrega sin vela).

chauffe-théière en fonte à 1 brûleur avec couvercle amovible (livraison sans bougie).

	∅ cm	↑ cm	Farbe / Colour	€
10994	13	7,5	■	16,40

**Untersetzer aus Gusseisen mit Antirutschfüßchen / cast iron coaster with non-slip feet**

	∅ cm	↑ cm	Farbe / Colour	€
10993	13,5	1,5	■	5,50

**Teebox**

tea-box  
caja para té  
boîte à thés et infusions



**Box aus Rubberwood mit Sichtfenster, mit Aufschrift „Tee“, 4 Kammern können mit je 30 kuvertierten Teebeuteln bestückt werden**

rubber wood box with clear transparent window, with inscription „Tee“, 4 chambers for approx. 30 tea bags each

caja de madera de goma clara con ventana transparente, con inscripción „Tee“, 4 compartimentos, y cada uno para aproximadamente 30 bolsitas de té

en bois d'hévéa clair avec fenêtre, avec inscription „Tee“, 4 compartiments, pour environ 30 sachets chacun

	cm	↑ cm	Farbe / Colour	€
11575	33,5 x 20	9	■	21,00
11574	33,5 x 20	9	■	21,00

	cm	↑ cm	Farbe / Colour	€
11576	33,5 x 20	9	■ ohne Aufschrift / without inscription sin inscripción / sans inscription	21,00

**Teebox**

tea-box  
caja para té  
boîte à thés et infusions



**Box aus Rubberwood mit Sichtfenster, mit Aufschrift „Tee“, 12 Kammern können mit je 12 kuvertierten Teebeuteln bestückt werden**

rubber wood box with clear transparent window, with inscription „Tee“, 12 chambers for approx. 12 tea bags each

caja de madera de goma clara con ventana transparente, con inscripción „Tee“, 12 compartimentos, y cada uno para aproximadamente 12 bolsitas de té

en bois d'hévéa clair avec fenêtre, avec inscription „Tee“, 12 compartiments, pour environ 12 sachets chacun

	cm	↑ cm	Farbe / Colour	€
11775	31 x 28	9	■	28,00
11776	31 x 28	9	■	28,00

**Teebox / Multibox**

tea caddy  
caja para té  
boîte à thés et infusions



**3 Fächer für kuvertierte Teebeutel, 1 Fach für Zucker, Kekse, etc., Deckel aufklappbar**

3 compartments for tea bags, 1 compartment for sugar, biscuits, etc., hinged lid

3 compartimentos para bolsitas de té, 1 compartimento para azúcar, galletas, etc. tapa abatible

3 compartiments pour sachets de thé, 1 compartiment pour sucre, biscuits, etc., couvercle abatible

	cm	↑ cm	€
11563	22 x 17	9	21,00

# BARISTA

*Life begins after coffee*



### Milch-/Universalkanne

non stick jug  
jarra antiadherente  
pichet antiadhésif

Antihafbeschichtet, perfekt für die Herstellung von Milchschaum

coated, for baristas frothing hot milk  
revestimiento, ideal para espume de leche  
revêtement, idéal pour faire mousser le lait



	Ø cm	↑ cm	ltr.	€
10334	8,0	10,0	0,35	15,00
10335	9,0	11,5	0,60	18,20
10336	10,5	13,0	0,80	24,20



### Milch- / Universalkanne

milk / water jug  
jarra leche / agua  
pichet à eau / lait

außen hochglanzpoliert, innen matt poliert, mit Maßskalierung innen

outside mirror polished, inside matt polished, with dimension scaling inside  
exterior pulido brillante, interior pulido mate, con escala de dimensiones en el interior  
extérieur poli brillant, intérieur poli mat, avec une échelle de dimension à l'intérieur



	Ø cm	↑ cm	ltr.	€
10328	8,0	10,0	0,35	7,80
10329	9,0	11,5	0,6	11,20
10330	10,5	13,0	0,8	15,00
10331	12,0	16,5	1,3	22,00
10332	13,5	18,0	2,0	26,40



### Milch- / Universalkanne „VEGAN“

milk / water jug  
jarra leche / agua  
pichet à eau / lait

außen hochglanzpoliert, innen matt poliert, mit Gravur „VEGAN“

outside mirror polished, inside matt polished, with engraving „VEGAN“  
exterior pulido brillante, interior pulido mate, con grabado „VEGAN“  
extérieur poli brillant, intérieur poli mat, avec gravure „VEGAN“



	Ø cm	↑ cm	ltr.	€
10350	9,0	11,5	0,6	14,90
10351	10,5	13,0	0,8	18,90





10361

### Milch- / Universalkanne

milk / water jug  
jarra leche / agua  
pichet à eau / lait



**außen weiß pulverbeschichtet, innen matt poliert**

outside white powder coated, inside matt polished  
exterior recubrimiento de polvo blanco, interior pulido mate  
extérieur revêtement en poudre blanc, intérieure poli mat

	Ø cm	↑ cm	ltr.	€
10360	8,0	10,0	0,35	15,60
10361	9,0	10,0	0,50	19,50
10362	9,5	11,5	0,75	21,40



**mit Gravur am Boden**  
with engraving on the bottom



10323

### Kaffeekanne

coffee pot  
cafetera  
pichet à café



**hochglanzpoliert, mit Klappdeckel**

mirror polished, with hinged cover  
pulido brillante, tapa con bisagra  
poli brillant, couvercle à charnière

	Ø cm	↑ cm	ltr.	€
10323	8,0	11,5	0,35	9,60
10322	9,0	14,0	0,6	13,00
10325	10,5	15,5	0,9	18,00
10326	12,0	18,5	1,5	24,40
10327	13,5	20,0	2,0	30,00

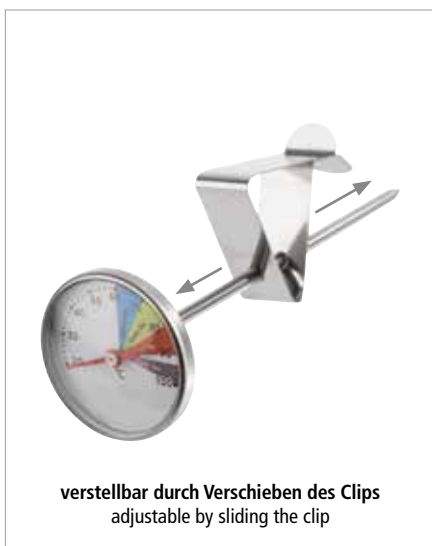

**verstellbar durch Verschieben des Clips**  
adjustable by sliding the clip

### Thermometer für Milchkännchen

thermometer for milk / water jug  
termómetro para jarra leche / agua  
thermomètre pour pichet à eau / lait



**mit Clip, höhenverstellbar, Temperaturbereich 20°C bis 100°C, Graduierung 2°C**

with clip, height adjustable, temperature range 20°C to 100°C, graduation 2°C  
con clip, regulable en altura, rango de temperatura de 20°C a 100°C, graduación 2°C  
avec clip, réglable en hauteur, plage de température 20°C à 100°C, graduation 2°C

	Ø cm	↑ cm	€
10355	4,0	13,5	5,80



**Anwendungsbeispiel**  
application example



### Mini-Milchkanne „SNACKHOLDER“ 4er Set

mini milk can, 4 pcs.  
lechera en formato mini, set de 4  
pot à lait mini, set de 4



	Ø cm	↑ cm	ltr.	pcs.	€ / set
40640	4,5	5	0,08	4	16,40



**Milchkännchen / Sahnegießer, 4er Set**

milk/cream jugs, 4 pcs.  
pack de 4 jarritas para leche o crema  
pack de 4 crémiers

hochglanzpoliert, für Kaffeesahne, mit Griff, Inhalt à 25 ml  
mirror polished, for coffee-cream, with handle, capacity à 25 ml  
pulido brillante, para crema de café, con asa, capacidad 25 ml  
poli brillant, avec anse, 25 ml



	Ø cm	↑ cm	ltr.	pcs.	€ / set
10321	3,5	3,5	0,025	4	15,00



**Milchkännchen / Sahnegießer**

milk / cream jug  
jarra de leche/ crema  
pichet à eau ou lait



	Ø cm	↑ cm	ltr.	€
10318	4	4	0,05	2,40
10319	5	5	0,09	3,00
10320	6	6	0,15	3,60



**Allzweckgießer**

pourer  
bote vertedor universal  
pot verseur universel  
für Honig, Kaffeesahne, etc., Schraubdeckel  
for honey, cream, etc., screw cap  
para miel, crema, etc., tapa de rosca  
pour le miel, le lait, la crème, etc., bouchon à vis



	Ø cm	↑ cm	ltr.	€
00765	8,5	13,5	0,3	9,00

Ersatzglasbehälter / spare glas-container / contenedor de repuesto / récipient verre de rechange

00768				1,80
-------	--	--	--	------



**Allzweckgießer**

pourer  
dosificador  
doseur  
für Honig, Kaffeesahne, etc., Schraubdeckel  
for honey, cream, etc., screw cap  
para miel, crema, etc., tapa de rosca  
pour le miel, le lait, la crème, etc., bouchon à vis



	Ø cm	↑ cm	ltr.	€
40488	8	12,5	0,25	6,80



**Zuckerdosierer**

sugar dispenser  
azucarero  
sucrier



Schraubdeckel, mit Dosierrohr / screw cap, with dosing tube / tapa de rosca y tubo dosificador / bouchon à vis et tube doseur

	Ø cm	↑ cm	ltr.	€
40509	6	14,5	0,2	12,00
40508	6,5	14,5	0,2	11,50



**Zuckerdosierer**

sugar dispenser  
azucarero  
sucrier



Schraubdeckel, mit Dosierrohr / screw cap, with dosing tube / tapa de rosca y tubo dosificador / bouchon à vis et tube doseur

	Ø cm	↑ cm	ltr.	€
00766	8,5	15	0,3	5,50

Ersatzglasbehälter / spare glas-container / contenedor de repuesto / récipient verre de rechange

	€
00768	1,80



**Zuckerdosierer**

sugar dispenser  
azucarero  
sucrier



Schraubdeckel, mit Dosierrohr / screw cap, with dosing tube / tapa de rosca y tubo dosificador / bouchon à vis et tube doseur

	Ø cm	↑ cm	ltr.	€
40506	7,5	17,0	0,32	5,40



**Zuckerdosierer**

sugar dispenser  
azucarero  
sucrier



Schraubdeckel, mit Dosierrohr / screw cap, with dosing tube / tapa de rosca y tubo dosificador / bouchon à vis et tube doseur

	Ø cm	↑ cm	ltr.	€
40486	8	15	0,25	3,90



**Zuckerdosierer**

sugar dispenser  
azucarero  
sucrier



Schraubdeckel, mit Dosierrohr / screw cap, with dosing tube / tapa de rosca y tubo dosificador / bouchon à vis et tube doseur

	Ø cm	↑ cm	ltr.	€
40490	8,5	12	0,15	3,90
40494	8,0	15	0,25	3,90

Ersatzglasbehälter / spare glas-container / contenedor de repuesto / récipient verre de rechange

	fits to	€
40498	40490	1,80
40499	40494	1,80



**Zuckerdosierer**

sugar dispenser  
azucarero  
sucrier



Schraubdeckel mit Klappe, mit Dosierklappe / screw cap, with dosing flap / tapa de rosca, con tubo dosificador / bouchon à vis, avec couvercle doseuse

	Ø cm	↑ cm	ltr.	€
40487	7,5	13,5	0,32	4,80

**Zuckerdosierer „OLD FASHIONED“** / sugar dispenser / azucarero / sucrier

	Ø cm	↑ cm	ltr.	€
40510	7,5	14	0,35	4,40



**Zuckerkugel**

sugar pot  
azucarero  
sucrier



hochglanzpoliert, mit Rolldeckel  
mirror polished, rolltop cover  
pulido brillante, tapa abatible  
poli brillant, couvercle abattant

	Ø cm	↑ cm	€
00033	13,5	15	14,40



**Milch- und Zucker-Set**

milk and sugar set  
set de crema y azúcar  
set lait et sucre



5-teilig: Tablett, Milchkanne, Zuckerdose mit Deckel, Löffel, Akazienholz, Edelstahl beschichtet, schwarz

5 pcs.: tray, milk jug, sugar bowl with lid, spoon, acacia wood, stainless inox coated, black  
set de 5: bandeja, jarra de leche, azucarero con tapa, cuchara, madera de acacia, acero inoxidable revestimiento, negro

set de 5: plateau, pichet à lait, sucrier avec couvercle, cuillère, bois d'acacia, acier inox revêtement, noir

	cm	↑ cm	€ / set
00634	19 x 10	10,5	26,00



**Teebrühsieb**

snap mesh tea ball  
infusor de té, pinza con malla  
boule à thé avec pince



matt poliert, mit feinem Sieb, aufklappbar / matt polished, with fine mesh, hinged / pulido mate, con malla fina, con bisagra / poli mat, maille fine, avec charnière

	Ø cm	→ cm	€
74750	4,5	15,5	2,60



**Zitronenschnitzpresse**

lemon slice squeezer  
pinza exprimelimon  
pince presse citron

hochglanzpoliert, zum Auspressen von Zitronenscheiben / mirror polished, to press lemon slices / pulido brillante, para rodajas de limón / poli brillant, pour citrons en rondelle



	cm	€
71430	8 x 7	1,40

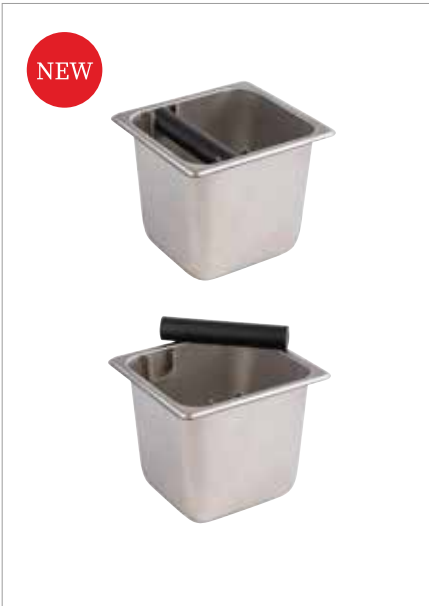

NEW

**GN 1/6 Abklopfbehälter**

GN 1/6 tapping container  
GN 1/6 contenedor knock-out  
GN 1/6 bac knock-out

mit Abklopfstange aus Silikon, rutschfester Boden

with silicone tapping rod, non-slip bottom  
con varilla de silicona, base antideslizante  
avec tige en silicone, fond antidérapant



	cm	↑ cm	ltr.	€
81611	17,6 x 16,2	15	2,4	19,00



rutschfester Boden  
non-slip bottom

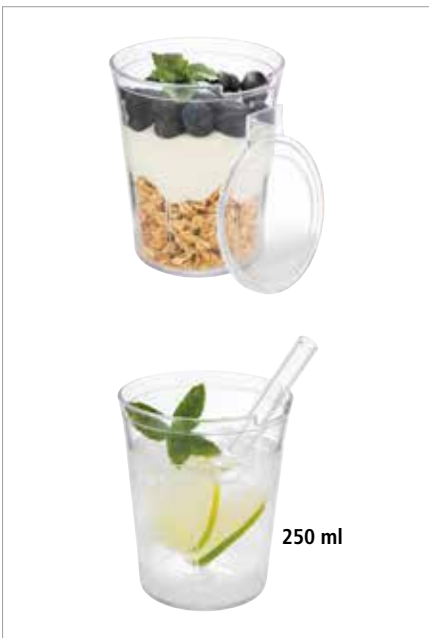

250 ml

**Becher Set „SUPER CUP“, 8er Set**

barrel mug set, 8 pcs.  
vasos, set de 8  
gobelets, set de 8

Set bestehend aus 8 Bechern + 8 Deckeln

set consists of 8 barrel mugs + 8 lids  
set compuesto por 8 vasos + 8 tapas  
set composé de 8 gobelets + 8 couvercles



IDEAL  
FÜR  
„TAKE AWAY“

	Ø cm	↑ cm	ltr.	pcs.	€ / set
10506	8	10	0,25	8	19,00



mit Stapelnocke  
with stacking cam



rutschfester Deckel  
non-slip lid



Servierbeispiel Deckel  
presentation example cover



**NEW** SNUG



**Espressotasse „SNUG“**

espresso cup  
taza de espresso  
tasse à espresso



Porzellan, Griff: 2 cm / porcelain, handle: 2 cm / porcelana, asa: 2 cm / porcelaine, poignée: 2 cm

	Ø cm	↑ cm	ltr.	Farbe / Colour	VE / unit	€/ pc.
16000	6	5,5	0,08		6	2,90
16001	6	5,5	0,08		6	2,90
16002	6	5,5	0,08		6	2,90



**Espressountertasse „SNUG“**

espresso saucer  
platillo de espresso  
soucoupe à espresso



Porzellan / porcelain / porcelana / porcelaine

	Ø cm	↑ cm	Farbe / Colour	VE / unit	€/ pc.
16009	11,5	2		6	2,80
16010	11,5	2		6	2,80
16011	11,5	2		6	2,80





**Kaffeetasse „SNUG“**

coffee cup  
taza de café  
tasse à café



Porzellan, Griff: 2 cm / porcelain, handle: 2 cm / porcelana, asa: 2 cm / porcelaine, poignée: 2 cm

	Ø cm	↑ cm	ltr.	Farbe / Colour	VE / unit	€ / pc.
16003	9,5	6	0,2		6	4,10
16004	9,5	6	0,2		6	4,10
16005	9,5	6	0,2		6	4,10



**Kaffeuntertasse „SNUG“**

coffee saucer  
platillo de café  
soucoupe à café



Porzellan / porcelain / porcelana / porcelaine

	Ø cm	↑ cm		Farbe / Colour	VE / unit	€ / pc.
16012	14,5	2,5			6	3,40
16013	14,5	2,5			6	3,40
16014	14,5	2,5			6	3,40



**Cappuccinotasse „SNUG“**

cappuccino cup  
taza de cappuccino  
tasse à cappuccino



Porzellan, Griff: 3 cm / porcelain, handle: 3 cm / porcelana, asa: 3 cm / porcelaine, poignée: 3 cm

	Ø cm	↑ cm	ltr.	Farbe / Colour	VE / unit	€ / pc.
16006	10,5	6,5	0,3		6	5,60
16007	10,5	6,5	0,3		6	5,60
16008	10,5	6,5	0,3		6	5,60



**Cappuccinountertasse „SNUG“**

cappuccino saucer  
platillo de cappuccino  
soucoupe cappuccino



Porzellan / porcelain / porcelana / porcelaine

	Ø cm	↑ cm		Farbe / Colour	VE / unit	€ / pc.
16015	15,5	2,5			6	3,80
16016	15,5	2,5			6	3,80
16017	15,5	2,5			6	3,80



TWINZ



„espresso size“

**Gläser, 2er Set „TWINZ“**

glasses, 2 pcs. set  
vasos, set de 2  
verres, set de 2

**doppelwandig, ideal für Espresso**

glass, double-walled, ideal for espresso  
vidrio, doble pared, ideal para espresso  
verre, à double paroi, idéal pour l'espresso



	Ø cm	↑ cm	ltr.	pcs.	€/ set
10370	6	6,5	0,08	2	8,00



„coffee and tea size“

**Gläser, 2er Set „TWINZ“**

glasses, 2 pcs. set  
vasos, set de 2  
verres, set de 2

**doppelwandig, ideal für Kaffee oder Tee**

glass, double-walled, ideal für coffee or tea  
vidrio, doble pared, ideal para café o té  
verre, à double paroi, idéal pour le café ou le thé



	Ø cm	↑ cm	ltr.	pcs.	€/ set
10371	8,5	8,5	0,23	2	10,00



„latte macchiato size“

**Gläser, 2er Set „TWINZ“**

glasses, 2 pcs. set  
vasos, set de 2  
verres, set de 2

**doppelwandig, ideal für Latte Macchiato**

glass, double-walled, ideal for Latte Macchiato  
vidrio, doble pared, ideal para latte macchiato  
verre, à double paroi, idéal pour le latte macchiato



	Ø cm	↑ cm	ltr.	pcs.	€/ set
10372	8,5	14	0,38	2	12,00



# Der nachhaltige Mehrwegbecher – made in Germany



eco-friendly



Das Ribbendesign isoliert die Hitze – kein „Verbrennen“ der Finger möglich

The rib design insulates the heat - no „burning“ of the fingers possible

- ✓ aufsteckbarer Deckel mit Trinköffnung
- ✓ 100% recyclebar
- ✓ spülmaschinengeeignet
- ✓ stapelbar mit und ohne Deckel
- ✓ schwappsicher

Mehrwegbecher individuell mit Ihrem Logo/Namen herstellbar ab 500 Stck. – sprechen Sie uns an!

Reusable cups can be individually produced with your logo/name. From 500 pieces - please contact us!

clip-on lid with drinking opening

100% recyclable

dishwasher safe

stackable with and without lid

slosh-/leak-proof



## To Go Mehrwegbecher

To Go reusable cup  
vaso reutilizable To Go  
tasse réutilisable To Go

**Becher (ohne Deckel)**

cup (without cover)

vaso (sin tapa)

tasse (sans couvercle)



	Ø cm	↑ cm	ltr.	Farbe / Colour	VE / unit	€/ pc.
66910	8,5	13,5	0,4		48	2,20
66911	8,5	13,5	0,4		48	2,20
66912	8,5	13,5	0,4		48	2,20
66913	8,5	13,5	0,4		48	2,20

**Deckel / cover / tapa / couvercle**

	Ø cm	↑ cm	Farbe / Colour	VE / unit	€/ pc.
66914	8,5	2,5		48	1,10
66915	8,5	2,5		48	1,10
66916	8,5	2,5		48	1,10
66917	8,5	2,5		48	1,10

# DRINKING BOTTLES



**Trinkflasche**  
drinking bottle  
cantimplora  
gourde

EDELSTAHL  
STAINLESS  
INOX  
18/8

HOLZ  
WOOD

die doppelwandige Vakuumflasche aus Edelstahl hält Heißes 12 Stunden heiß und Kaltes 24 Stunden kalt, 100% auslaufsicher

the double-walled stainless steel vaccum bottle keeps hot drinks hot for 12 hours and cold drinks cold for 24 hours, 100% leak proof

la cantimplora al vacío de acero inoxidable de doble pared mantiene las bebidas calientes durante 12 horas y las frías durante 24 horas, 100% transporte sin salpicaduras

la gourde à vide en acier inoxydable à double paroi permet de conserver les boissons chaudes pendant 12 heures et les boissons froides pendant 24 heures, 100% transport sans éclaboussures

	Ø cm	↑ cm	ltr.	€
66905	7,5	24,5	0,5	11,00



**Trinkflasche**  
drinking bottle  
cantimplora  
gourde

EDELSTAHL  
STAINLESS  
INOX  
18/8

HOLZ  
WOOD

die doppelwandige Vakuumflasche aus Edelstahl hält Heißes 12 Stunden heiß und Kaltes 24 Stunden kalt, 100% auslaufsicher

the double-walled stainless steel vaccum bottle keeps hot drinks hot for 12 hours and cold drinks cold for 24 hours, 100% leak proof

la cantimplora al vacío de acero inoxidable de doble pared mantiene las bebidas calientes durante 12 horas y las frías durante 24 horas, 100% transporte sin salpicaduras

la gourde à vide en acier inoxydable à double paroi permet de conserver les boissons chaudes pendant 12 heures et les boissons froides pendant 24 heures, 100% transport sans éclaboussures

	Ø cm	↑ cm	ltr.	€
66906	7,5	29,5	0,75	13,60



...immer dabei



mit Schraubverschluss  
with screw cap

inkl. Ersatzdichtung  
incl. spare gasket

500 ml

750 ml

NEW

# DRINKING BOTTLES



NEW



66907 0,55 ltr



66908 0,75 ltr



66909 1 ltr

**Trinkflasche**  
drinking bottle  
botella para beber  
gourde

Glas mit Schraubverschluss aus 18/8 Edelstahl  
screw cap made of 18/8 stainless steel  
tapón de rosca de 18/8 acero inoxidable  
bouchon à vis en 18/8 acier inox

GLAS  
GLASS

EDELSTAHL  
STAINLESS  
INOX  
18/8

PP  
POLYPROP.

SILIKON  
SILICON



	Ø cm	↑ cm	ltr.	€
66907	6,5	23,5	0,55	4,60
66908	7	26,5	0,75	5,60
66909	7,5	28,5	1	6,60



66907

66908

66909



mit Schraubverschluss  
with screw cap



66907

0,55 ltr

66908

0,75 ltr

66909

1 ltr



**Tablett**

tray  
bandeja  
plateaux



Melamin, schwarz, mit Antirutsch-Füßchen, passendes Schneidebrett Nr. 762, 763

melamine, black, with non-slip feet, suitable cutting board art. 762, 763

melamina, negro, con pies antideslizantes, tabla de cortar adecuada art. 762, 763

mélamine, noir, avec pieds antidérapants, planche à découper appropriées art. 762, 763

	cm	↑ cm		€
85225	67 x 38	4		75,00



**Tablett „VINTAGE“**

tray  
bandeja  
plateau



Antik-Edelstahl-Look

stainless steel antique look

acero estilo antiguo

acier style antique

	cm	↑ cm		€
30130	26,0 x 13,5	1,5	rectangular	8,00
30131	34,0 x 18,0	1,5	rectangular	13,20
30132	38,0 x 26,5	1,5	rectangular	21,00
30133	25,5 x 16,0	3,0	rectangular	16,00
30140	20,0 x 14,5	1,0	oval	5,00
30141	26,5 x 19,5	1,0	oval	7,60
30142	29,0 x 22,0	1,0	oval	9,80

passende Schälchen / fitting bowls / cuencos adecuados / bols appropriés



	Ø cm	↑ cm	ltr.	€
40655	7,5	5,5	0,17	3,20
40656	7,5	10	0,35	4,00



Wachspapier „SNACKHOLDER“ / greaseproof paper squares

papel alimenticio para cucurucho / papier alimentaire pour cornet



	cm	pcs.	Motiv: Zeitung	€ / set
40670	42 x 25	500	Motiv: Zeitung	59,00



Servierbeispiel  
presentation example

**Serviertablett „KAFFEEHAUS“**

tray  
bandeja  
plateau

**matt poliert, Rand eingerollt**

matt polished, rolled edge

acabado pulido efecto pulido mate, borde redondeado

effet poli mat, bord rond



	cm	↑ cm	€
30119	23 x 23	1,5	10,90
30118	21,5 x 13	1,5	7,90

**Serviertablett „KAFFEEHAUS“**

tray  
bandeja  
plateau

**matt poliert, oval, Rand eingerollt**

matt polished, oval, rolled edge

pulido mate, oval, borde redondeado

poli mat, ovale, bord rond

**für Zucker und Sahne / for sugar and cream / para azúcar y crema / pour le sucre et la crème**

	cm	↑ cm	€
30111	20,0 x 14,5	0,5	4,70

**für eine Tasse / for one cup / para una taza / pour une tasse**

	cm	↑ cm	€
30112	26,5 x 19,5	0,5	7,00

**für zwei Tassen / for two cups / para dos tazas / pour deux tasses**

	cm	↑ cm	€
30113	29,0 x 22,0	0,5	7,50

**Serviertablett „KAFFEEHAUS“**

tray  
bandeja  
plateau

**hochglanzpoliert, oval, Rand eingerollt**

mirror polished, oval, rolled edge

pulido brillante, ovalado, borde redondeado

poli brillant, ovale, bord rond

**für Zucker und Sahne / for sugar and cream / para azúcar y crema / pour le sucre et la crème**

	cm	↑ cm	€
30115	20,0 x 14,5	0,5	4,70

**für eine Tasse / for one cup / para una taza / pour une tasse**

	cm	↑ cm	€
30116	26,5 x 19,5	0,5	7,00

**für zwei Tassen / for two cups / para dos tazas / pour deux tasses**

	cm	↑ cm	€
30117	29,0 x 22,0	0,5	7,50



# TRAYS



30148



30149

## Serviertablett „KAFFEEHAUS“

tray  
bandeja  
plateau

hochglanzpoliert, stabiler Rand eingerollt  
mirror polished, stable edge rolled in  
pulido brillante, borde estable enrollado  
poli brillant, bord stable enroulé



	cm	↑ cm	€
30148	Ø 27	1,5	6,00
30149	30 x 15,5	1,5	6,80

passende Hauben / cover / campana / cloche



	cm	↑ cm	suitable for	€
11055	Ø 23	12,0	30148	5,70
11056	26 x 12	10,0	30149	7,90



11055

30148



11056

30149

Servierbeispiel  
presentation example



## Serviertablett „KAFFEEHAUS“

tray  
bandeja  
plateau

Innenfläche ziseliert, Rand eingerollt  
chiselled inner surface, rolled edge  
superficie interior cincelada, borde redondeado  
surface intérieure ciselée bord rond



	cm	VE / unit	€ / pc.
30114	30 x 22	48	3,00



84251

## Serviertablett „KAFFEEHAUS“

tray  
bandeja  
plateau



	cm	↑ cm	Farbe / Colour	€
84251	26,0 x 20,0	1,5	■	4,80
84253	28,5 x 21,5	1,5	■	5,40

**Tablett „BISTRO“**tray  
bandeja  
plateau**rutschfest, mit 2 Griffmulden und Stapelrand**

non-slip, two open handles, stackable edge

anti-deslizante, 2 asas

antidérapant, 2 anses



	Ø cm	↑ cm	Farbe / Colour	€
84045	35,5	4,5	■	26,00



00510

**Serviertablett „HAPPY HOUR“**tray  
bandeja  
plateau**rutschfeste Oberfläche / non-slip surface / superficie anti-deslizante / surface antidérapante**

	Ø cm	↑ cm	Farbe / Colour	€
00510	32	1,5	■	23,00
00511	38	1,5	■	28,00
00515	43	1,5	■	32,00



00500

**Bierglasträger „NON-SLIP“**beer rack  
bandeja para cerveza  
porte verre à bière**rutschfeste Oberfläche / non-slip surface / superficie anti-deslizante / surface antidérapante**

	Ø cm	↑ cm	Farbe / Colour	€
00500	36	3,5	■	21,00

	cm	↑ cm	Farbe / Colour	€
00506	28 x 20	1,5	■	9,60



00548

**Tablett „GASTRO“**tray  
bandeja  
plateau**rutschfeste Oberfläche / non-slip surface / superficie anti-deslizante / surface antidérapante**

	Ø cm	↑ cm	Farbe / Colour	€
00547	27,5	2	■	7,60
00548	35,5	2	■	9,60
00549	40,5	2	■	11,40



00502

**Serviertablett „NON-SLIP“**tray non-slip  
bandeja antideslizante  
plateau antiglisse**rutschfeste Oberfläche**

non-slip surface

superficie antideslizante

surface antidérapante



	cm	↑ cm	GN	Farbe / Colour	€
00502	53 x 32,5	1,5	1/1	■	25,00
00508	46 x 36,0	2		■	22,90



# FAST FOOD TRAYS



## Fast Food-Tablett

snack tray

bandeja autoservicio y snacks

plateau self-service et snacks



	cm	↑ cm	GN	Farbe / Colour	€
00530	35 x 27,0	2			3,50
00535	41 x 30,5	2			4,70
00540	45 x 35,5	2			5,90
00552	53 x 32,5	2	1/1		7,20

	cm	↑ cm	GN	Farbe / Colour	€
00531	35 x 27,0	2			3,50
00536	41 x 30,5	2			4,70
00541	45 x 35,5	2			5,90
00553	53 x 32,5	2	1/1		7,20

	cm	↑ cm	GN	Farbe / Colour	€
00532	35 x 27,0	2			3,50
00537	41 x 30,5	2			4,70
00542	45 x 35,5	2			5,90
00554	53 x 32,5	2	1/1		7,20

	cm	↑ cm	GN	Farbe / Colour	€
00533	35 x 27,0	2			3,50
00538	41 x 30,5	2			4,70
00543	45 x 35,5	2			5,90
00555	53 x 32,5	2	1/1		7,20

	cm	↑ cm	GN	Farbe / Colour	€
00534	35 x 27,0	2			3,50

	cm	↑ cm	GN	Farbe / Colour	€
00539	35 x 27,0	2			3,50



stapelbar  
stackable





**Rechnungstablett**  
bill presenter  
porta cuenta  
porte-addition  
**mit Klemme für Rechnung**  
with clip for bill  
con clip para la nota  
avec clip pour la note



	cm	↑ cm	€
30108	20 x 12	1,5	2,40



**Rechnungstablett**  
bill presenter  
porta cuenta  
porte-addition  
**mit Klemme für Rechnung**  
with clip for bill  
con clip para la nota  
avec clip pour la note



	cm	↑ cm	€
30110	17 x 11	1	6,30



**Tischkrümelentferner**  
crumber  
recogemigas  
ramasse-miettes



**geschliffene Edelstahlkante, matt poliert, einfache Handhabung**  
flat grinded stainless steel edge, matt polished, easy to handle  
geschliffene Edelstahlkante, pulido mate, fácil de usar, mango hueco  
geschliffene Edelstahlkante, poli mat, manche creux, simple à utiliser

	Ø cm	↑ cm	€
00581	19,5 x 4,5	1	8,00



71400

**Rezeptionsglocke**  
ring bell  
timbre  
sonnette



	Ø cm	↑ cm	Farbe / Colour	€
71400	8,5	6,0	■	6,20
71433	10,0	6,5	■	8,20



# ASHTRAYS



00582 **black**

00583 **yellow**

00584 **turquoise**

00585 **white**

## Windaschenbecher

ashtray  
cenicero  
cendrier



**Metall verchromt, Glas gefrostet, mit Bajonettverschluss**

metal chrome plated, glass frosted, bayonet lock

metal cromado, opaco mate, cierre de bayoneta

métal chromé, mat, verrouillage par baïonnette

	Ø cm	↑ cm	Farbe / Colour	€
00582	9,5	8		9,40
00583	9,5	8		9,40
00584	9,5	8		9,40
00585	9,5	8		9,40



00560 **white**

00561 **berry**

00562 **green**

00563 **blue**

00564 **black**

## Windaschenbecher

ashtray  
cenicero  
cendrier



**Metall verchromt, Glas gefrostet, mit Bajonettverschluss**

metal chrome plated, glass frosted, bayonet lock

metal cromado, opaco mate, cierre de bayoneta

métal chromé, mat, verrouillage par baïonnette

	Ø cm	↑ cm	Farbe / Colour	€
00560	9,5	8		9,40
00561	9,5	8		9,40
00562	9,5	8		9,40
00563	9,5	8		9,40
00564	9,5	8		9,40



**Windaschenbecher**ashtray  
cenicero  
cendrier**Metall matt-schwarz, Glas gefrostet, mit Bajonettverschluss**

metal matt black, glass frosted, with bayonet lock

metal negro mate, opaco mates, con cierre de bayoneta

métal noir mat, givré, verrouillage par baïonnette

	Ø cm	↑ cm	Farbe / Colour	€
00558	9,5	8	■	9,40

**Drehaschenbecher „PUSH“**ashtray  
cenicero  
cendrier**Deckel mit Drehmechanismus, mit Bajonettverschluss**

with rotary button, bayonet lock

con botón giratorio, cierre de bayoneta

tourne par pression sur le bouton, verrouillage par baïonnette

	Ø cm	↑ cm	€
00568	9,5	11	11,00

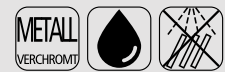
**Drehmechanismus**  
rotary button**Drehaschenbecher „KLASSIKER“**ashtray  
cenicero  
cendrier giratoire**Deckel mit Drehmechanismus**

with rotary button

con botón giratorio

tourne par pression sur le bouton

	Ø cm	↑ cm	Farbe / Colour	€
00054	13,0	10,5	■	9,40
00056	10,5	11	■	8,40

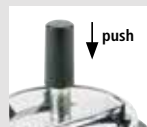
**Drehmechanismus**  
rotary button**Windaschenbecher „ELEMENT“**ashtray  
cenicero  
cendrier**möbelschonende Unterseite**

non-scratching undersurface

base anti rayaduras

avec revêtement antirayures

	Ø cm	↑ cm	Farbe / Colour	€
00570	10,5	5,0	■	8,40
00559 <span style="color:red">NEW</span>	10,5	5,0	■	7,80



**Windaschenbecher**

ashtray  
cenicero  
cendrier



**Deckel hochglanzpoliert, Behälter matt poliert, mit Windschutzdeckel**  
lid mirror polished, container matt polished, with windcover  
con tapa antiviento pulida brillante y contenedor pulido efecto pulido mate  
couvercle anti-vent brillant, corps poli mat poli maté

	Ø cm	↑ cm	€
00052	12	5,5	9,80



**Klappmechanismus**  
rotary button



**Windaschenbecher**

ashtray  
cenicero  
cendrier



**matt poliert, mit Windschutzdeckel**  
matt polished, with windcover  
pulido mate apilable, tapa para el viento  
poli mat, empilable, couvercle anti-vent

	Ø cm	↑ cm	€
00090	10	4,5	8,00
00091	12	4,5	8,80



**stapelbar**  
stackable



**Windaschenbecher**

ashtray  
cenicero  
cendrier



	Ø cm	↑ cm	Farbe / Colour	€
83488	11,5	5	White	6,20
83489	11,5	5	Black	6,00



**Windaschenbecher**

ashtray  
cenicero  
cendrier



	Ø cm	↑ cm	Farbe / Colour	€
83610	10	4,0	White	5,00
83612	12	4,5	White	5,40
83611	10	4,0	Black	5,00
83613	12	4,5	Black	5,40



**Aschenbecher**

ashtray  
cenicero  
cendrier



	Ø cm	↑ cm	Farbe / Colour	€
83616	9,5	4,5	Black	2,80



Windaschenbecher „SMOKY“

ashtray  
cenicero  
cendrier

mit abnehmbarem Deckel  
with removable lid  
con tapa extraible  
avec couvercle amovible



	Ø cm	↑ cm	Farbe / Colour	€
00586	8,5	11,5	schwarz / black	5,00
00578	8,5	11,5	verzinkt / galvanised	6,00



Aschenbecher, 3er Set

ashtray, 3 pcs.  
set de 3 cenicero  
set de 3 cendriers



	Ø cm	↑ cm	Farbe / Colour	pcs.	€ / set
00576	8	3		3	3,00



Aschenbecher

ashtray  
cenicero  
cendrier

matt poliert, hochwertige schwere Ausführung

matt polished, high quality, heavy gauge  
pulido pulido mate, alta calidad, apilable  
poli mat, empilable, belle qualité



	Ø cm	↑ cm	€
00048	8	3	8,40
00050	10	3	10,00



Standascher „DIABOLO“

standing ashtray  
cenicero de pie  
cendrier sur pied

für den Innen- und Außenbereich, inklusive 1,5 kg Sand, eine Ascheschale für die Sand-  
befüllung und ein Metallsieb

for in,- outdoor use, included a bag of sand and a metal sieve

uso en interior o exterior, incluye una bolsa de arena y embudo de metal

usage en intérieur ou extérieur, livré avec un sac de sable et entonnoir métal



	Ø cm	↑ cm	€
00574	40	60	76,00



vielseitig nutzbar  
versatile

zerlegbar und stapelbar  
dismountable and stackable



Trittmechanismus  
step on bin



2 Lenkrollen  
mit Feststellern  
2 wheels with brakes



Gummilippe 55 cm breit, Abstand zwischen Gummilippe und Bodenblech 82 cm

**Tretbeutelhalter**

pedal bin  
soporte a pedal  
poubelle à pédale

geeignet für Müllbeutel bis 120 ltr., 110 x 70 cm

suitable for bags up to 120 ltr., 110 x 70 cm

apto para bolsas hasta 120 l., medidas sin bolsa 110 x 70 cm

apte pour sacs de 120 l., dim. sans sac 110 x 70 cm



	cm	↑ cm	€
00580	59 x 43	96	142,00



leichte Bedienung, Trittmechanismus  
easy handling, step on bin

# Lunchbox



## Lunchbox „M“

lunchbox  
fiambrella  
boîte à lunch



**Edelstahlbox mit Silikondichtung inkl. Trennsteg, auslaufsicher**

stainless steel box with silicone seal incl. divider, leak-proof

caja de acero inoxidable con junta de silicona y divisor extraíble, transporte sin salpicaduras

boîte en acier inox avec joint en silicone et diviseur amovible, transport sans éclaboussures

	cm	↑ cm	litr.	€
66900	18,5 x 13,5	6,5	0,8	14,50



## Lunchbox „L“

lunchbox  
fiambrella  
boîte à lunch



**Edelstahlbox mit Silikondichtung inkl. Trennsteg, auslaufsicher**

stainless steel box with silicone seal incl. divider, leak-proof

caja de acero inoxidable con junta de silicona y divisor extraíble, transporte sin salpicaduras

boîte en acier inox avec joint en silicone et diviseur amovible, transport sans éclaboussures

	cm	↑ cm	litr.	€
66901	20,5 x 14,5	6,5	1,1	17,00



## Lunchbox „XL“

lunchbox  
fiambrella  
boîte à lunch



**Edelstahlbox mit Silikondichtung inkl. Trennsteg, auslaufsicher**

stainless steel box with silicone seal incl. divider, leak-proof

caja de acero inoxidable con junta de silicona y divisor extraíble, transporte sin salpicaduras

boîte en acier inox avec joint en silicone et diviseur amovible, transport sans éclaboussures

	cm	↑ cm	litr.	€
66902	22,5 x 16,5	6,5	1,4	19,50



mit zwei Verschlüssen  
with 2 clasps

66900

0,8 ltr.



66901

1,1 ltr.



66902

1,4 ltr.



herausnehmbarer Trennsteg  
removable divider

auslaufsicher | leak-proof









# Kitchen & Servingtools

BANQUET .....	514
PROFI .....	516
CLASSIC .....	517
STOP TOOLS .....	518
POLYAMIDE KITCHENTOOLS .....	520
TONGS .....	522
TWEEZERS .....	529
TOOLTIME .....	530
CUTTERS   WHISKS .....	537
STRAINERS .....	538
MEASURING CUPS.....	542
MOUSSE RINGS .....	543
CAKE SETTING RINGS   DISPLAY TRAY .....	544
FUNNELS .....	546
SCOOPS .....	547
SQUEEZE BOTTLES .....	548
DISPENSERS   EGG BOXES .....	550
SQUEEZERS .....	551
PIZZA .....	552
SPOONS   WOOD .....	556

# BANQUET



Die Vorlegeserie BANQUET ist die passende Ergänzung zum Servieren am Buffet. Durch die mattierte Oberfläche und das gebogene Griffende wird BANQUET praktischen und optischen Ansprüchen gerecht.

The series BANQUET is the perfect addition for serving at the buffet. Due to the matt surface and the curved handle, BANQUET meets practical and optical requirements.

La serie BANQUET es la adición perfecta para servir en el buffet. Debido a la superficie mate y al mango curvado, BANQUET cumple con requisitos prácticos y ópticos.

La série BANQUET est l'ajout parfait pour servir au buffet. Grâce à la surface mate et la poignée incurvée, BANQUET répond aux exigences pratiques et optiques.



## Salat- / Servierlöffel „BANQUET“ salad spoon / serving spoon cuchara para ensalada / cuchara de servicio cuillère à salade / cuillère de service



	cm	Griff / handle cm	€
00588	6 x 5	17	5,60
00590	7,5 x 6	21	8,00



## Salatgabel „BANQUET“ salad fork tenedor de servicio para ensalada fourchette de service pour la salade



	cm	Griff / handle cm	€
00589	6 x 5	17	5,60
00591	7,5 x 6	21	8,00



## Schöpflöffel „BANQUET“ ladle cucharón louche



	cm	Griff / handle cm	€
00595	8,5 x 7,5	24	16,00



**Chafing Dish Löffel „BANQUET“**

serving spoon  
cuchara para servir  
cuillère de service



	cm	Griff / handle cm		€
00592	11 x 6,5	24		9,40
00593	11 x 6,5	24	geschlitzt / slotted	9,00



00593



**Dressinglöffel „BANQUET“**

dressing spoon  
cuchara de aliño  
cuillère à vinaigrette



	cm	Griff / handle cm		€
00594	6 x 4	30		11,50



**Pfannenwender „BANQUET“**

turner  
espátula  
spatule



	cm	Griff / handle cm		€
00587	10 x 7,5	21		9,00



**Fleischgabel „BANQUET“**

meat fork  
tenedor de carne  
fourchette à viande



	cm	Griff / handle cm		€
00596	8 x 2,5	13		4,90



**Serviergabel „BANQUET“**

fork  
tenedor de servicio  
fourchette de service



	cm	Griff / handle cm		€
00597	9 x 4	21		8,40



**Tortenheber „BANQUET“**

cake lifter  
pala de tartas  
pelle à gâteau  
eine Kante gezahnt  
one edge serrated  
un borde serrado  
denté sur un côté



	cm	Griff / handle cm		€
00598	14 x 6	13		7,00



Schöpföffel „PROFI“

ladle  
cacillo  
louche



	Ø cm	Griff / handle cm	ltr.	€
00711	6	28	0,050	12,20
00712	7	30	0,080	12,60
00713	8	32	0,125	13,60
00714	9	33	0,150	15,60
00715	10	35	0,250	16,30
00716	11	36	0,300	16,90



Schaumlöffel „PROFI“

skimmer  
espumadera  
écumoire



	Ø cm	Griff / handle cm	€
00721	10	34	13,20
00722	12	37	14,10
00723	14	40	15,40



Wender „PROFI“

turner  
espátula  
spatule



	cm	Griff / handle cm	€
00730	10 x 11,5	38	15,40



Servierlöffel „PROFI“

serving spoon  
cuchara de servicio  
cuillère de service



	cm	Griff / handle cm		€
00671	11 x 7	29	geschlitzt / slotted	9,20
00672	11 x 7	29		9,20



Spaghettilöffel „PROFI“

spaghetti spoon  
cuchara de espaguetis  
cuillère à spaghettis



	cm	Griff / handle cm	€
00673	10 x 7	29	9,90



**Servierlöffel „CLASSIC“**

servicing spoon  
cuchara de servicio  
cuillère de service



hochglanzpoliert, perforiert, Löcher Ø 4 mm, ergonomisch profilierter Hohl-Griff  
mirror polished, perforated, holes Ø 4 mm, ergonomic designed handle  
pulido brillante agujeros de Ø 4 mm, asa ergonómica  
brillant, trous Ø 4 mm, manche ergonomique

	cm	Griff / handle cm	€
75903	9,5 x 7	23,5	9,30



**Salatlöffel „CLASSIC“**

salad spoon  
cuchara para ensalada  
cuillère à salade



hochglanzpoliert, ergonomisch profilierter Hohl-Griff  
mirror polished, ergonomic designed handle  
pulido brillante, asa ergonómica  
poli brillant, manche ergonomique

	cm	Griff / handle cm	€
75902	8 x 6	21,5	9,30
75904	9,5 x 7	23,5	9,30



**Suppenkelle „CLASSIC“**

soup ladle  
cucharón de sopa  
louche de service



hochglanzpoliert, ergonomisch profilierter Hohl-Griff  
mirror polished, ergonomic designed handle  
pulido brillante, asa ergonómica  
poli brillant, manche ergonomique

	Ø cm	Griff / handle cm	litr.	€
75907	7	23	0,06	10,00
75908	9	24	0,1	11,00



**Saucengießlöffel „CLASSIC“**

sauce / gravy ladle  
cucharón de salsa  
cuillère à sauce



hochglanzpoliert, ergonomisch profilierter Hohl-Griff, fugenlos  
mirror polished, ergonomic designed handle, seamless  
pulido brillante, asa ergonómica, sin soldadura  
poli brillant, manche ergonomique, monobloc (sans soudure)

	cm	Griff / handle cm	litr.	€
75906	7 x 5,5	22	0,02	8,70

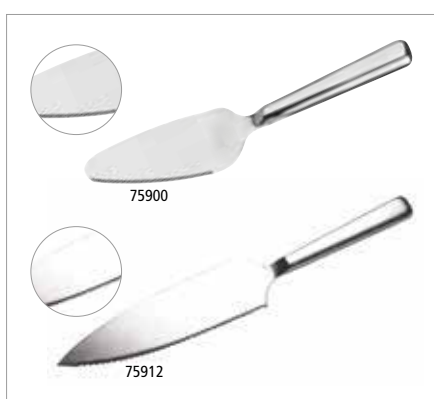

**Tortenheber „CLASSIC“**

cake lifter  
pala de tartas  
pelle à gâteau



hochglanzpoliert, mit einer gezahnten Kante, ergonomisch profilierter Hohl-Griff  
mirror polished, one edge serrated, ergonomic designed handle  
pulido brillante, canto dentado, mango ergonómico  
poli brillant, bord microdenté, manche ergonomique

	cm	Griff / handle cm	€
75900	8 x 5	10,5	8,60
75912	5 x 1	12	10,30

# STOP-TOOLS

Die STOP-Funktion verhindert, dass Gabel oder Löffel in das Gefäß rutschen.

The smart STOP-function prevent forks and spoon not to slip into the vessel.

La función STOP evita que los cubiertos se caigan dentro del recipiente.

La fonction STOP empêche les couverts de glisser dans le récipient.



**Servierlöffel**  
serving spoon  
cuchara para servir  
cuillère à servir



**Materialdicke 2,5 mm, ergonomischer, rutschfester Griff**  
material thickness: 2,5 mm, ergonomic antislip handle  
grosor: 2,5 mm, mango ergonómico antideslizante  
épaisseur : 2,5 mm, poignée ergonomique antidérapante

	cm	Griff / handle cm	€
00834	10 x 7,5	17	11,50



**Servierlöffel geschlitzt**  
slotted spoon  
cuchara para servir ranurada  
cuillère à servir rainurée



**Materialdicke 2,5 mm, ergonomischer, rutschfester Griff**  
material thickness: 2,5 mm, ergonomic antislip handle  
grosor: 2,5 mm, mango ergonómico antideslizante  
épaisseur : 2,5 mm, poignée ergonomique antidérapante

	cm	Griff / handle cm	€
00833	10 x 7,5	17	11,50



**Schöpflöffel**  
ladle  
cucharón  
louche



**Materialdicke 2,5 mm, ergonomischer, rutschfester Griff**  
material thickness: 2,5 mm, ergonomic antislip handle  
grosor: 2,5 mm, mango ergonómico antideslizante  
épaisseur : 2,5 mm, poignée ergonomique antidérapante

	Ø cm	Griff / handle cm	€
00832	9	17	12,50



**Fleischgabel**  
meat fork  
tenedor de carne  
fourchette à viande



**Materialdicke 2,5 mm, ergonomischer, rutschfester Griff**  
material thickness: 2,5 mm, ergonomic antislip handle  
grosor: 2,5 mm, mango ergonómico antideslizante  
épaisseur : 2,5 mm, poignée ergonomique antidérapante

	cm	Griff / handle cm	€
00831	10,5 x 4	17	11,50

**Servierlöffel geschlitzt**

slotted spoon

cuchara para servir ranurada

cuillère à servir rainurée

**ergonomischer, rutschfester Griff**

ergonomic antislip handle

mango ergonómico antideslizante

poignée ergonomique antidérapante



	cm	Griff / handle cm	€
00664	11 x 7	25	6,80

**Servierlöffel**

serving spoon

cuchara para servir

cuillère à servir

**ergonomischer, rutschfester Griff**

ergonomic antislip handle

mango ergonómico antideslizante

poignée ergonomique antidérapante



	cm	Griff / handle cm	€
00662	11 x 7	25	6,80

**Schöpföffel**

ladle

cucharón

louche

**ergonomischer, rutschfester Griff**

ergonomic antislip handle

mango ergonómico antideslizante

poignée ergonomique antidérapante



	cm	Griff / handle cm	ltr.	€
00670	9 x 8	25	0,10	7,50

**Wender**

turner

espátula

spatule

**ergonomischer, rutschfester Griff**

ergonomic antislip handle

mango ergonómico antideslizante

poignée ergonomique antidérapante



	cm	Griff / handle cm	€
00668	10 x 8	25	7,50

**Fleischgabel**

meat fork

tenedor de carne

fourchette à viande

**ergonomischer, rutschfester Griff**

ergonomic antislip handle

mango ergonómico antideslizante

poignée ergonomique antidérapante



	cm	Griff / handle cm	€
00666	10 x 3,5	25	6,80

# POLYAMIDE KITCHENTOOLS

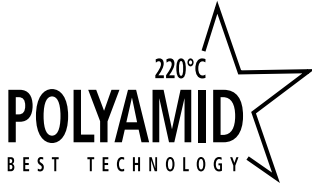

Das Profimaterial Polyamid besteht aus Nylon und Fiberglas. Hitzebeständig bis 220°C, extra hochwertige Profi-Qualität, gut geeignet für antihafbeschichtete Pfannen, ergonomischer Griff.

Polyamide is made of nylon and fiberglass. Heat-resistant up to 220°C, extra high quality, perfect for non-stick-coated pots and pans, ergonomic handle.

Poliamide de nylon y fibra de vidrio. Brevemente al calor hasta 220°, calta calidad profesional, ideal para sartenes antiadherentes, mango ergonómico.

Polyamide de nylon et fibre de verre, haute résistance brièvement à la chaleur jusque 220°C, qualité professionnelle, idéal pour les poêles antiadhérentes, manche ergonomique.



**Bratenwender**  
turner  
espátula  
spatule



	cm	Griff / handle cm	€
00603	11 x 9,5	23	6,70



**Pfannenwender**  
turner  
espátula  
spatule



	cm	Griff / handle cm	€
00600	11,5 x 9,5	23	6,60



**Pfannenwender**  
turner  
espátula  
spatule



	cm	Griff / handle cm	€
00604	15 x 7,5	15	4,70



**Pfannenwender**  
turner  
espátula  
spatule



	cm	Griff / handle cm	€
88642	13,5 x 9	18	4,80



**Pfannenwender**  
turner  
espátula  
spatule



	cm	Griff / handle cm	€
88640	13 x 6,5	15	4,70





**Servierlöffel**  
 serving spoon  
 cuchara de servicio  
 cuillère de service



	cm	Griff / handle cm		€
88608	12 x 7	23		6,60
00607	12 x 7	23	perforiert	6,20



**Schaumlöffel**  
 skimmer  
 espumadera  
 écumoire



	Ø cm	Griff / handle cm		€
00602	11,5	23		6,70



**Schöpflöffel**  
 ladle  
 cucharón  
 louche



	Ø cm	Griff / handle cm	ltr.	€
00606	9	23	0,1	6,90



**Spaghettizange**  
 spaghetti tongs  
 pinzas para espaguetis  
 pince à spaghettis



	cm	Griff / handle cm		€
88637	9 x 9	15		6,70



**Toastzange**  
 sandwich tongs  
 pinzas para sandwich  
 pince à toasts



	cm	Griff / handle cm		€
00601	11 x 8	18		8,50



**Salatzange**  
 salad tongs  
 pinzas para ensalada  
 pince à salade



	cm	Griff / handle cm		€
00629 <small>new</small>	8 x 5,5	17,5		6,50
00605	10 x 6	23		6,90



**Universalzange**  
all-purpose tongs  
pinzas multiusos  
pince multi-usages



Griff matt beschichtet / matt coated handle / mango recubierto de mate / poignée revêtue de mat

	→ cm	Farbe / Colour	€
75860	24	gelb	4,60
75861	24	rot	4,60
75862	24	grün	4,60
75863	24	blau	4,60
75864	24	schwarz	4,60

HACCP Farbkennzeichnung Konzept  
HACCP color coding concept



matte Antirutschummatellung  
matt anti-slip coating



**Universalzange**  
all-purpose tongs  
pinzas multiusos  
pince multi-usages



Griff matt beschichtet / matt coated handle / mango recubierto de mate / poignée revêtue de mat

	→ cm	Farbe / Colour	€
75865	30	gelb	5,40
75866	30	rot	5,40
75867	30	grün	5,40
75868	30	blau	5,40
75869	30	schwarz	5,40

HACCP Farbkennzeichnung Konzept  
HACCP color coding concept



matte Antirutschummatellung  
matt anti-slip coating



**Universalzange**  
all-purpose tongs  
pinza universal  
pince universelle



	cm	→ cm	Farbe / Colour	€
75825	7 x 5	22,5	vintage-look	10,90
75830	7 x 5	25	mirror polished	10,80
75831	7 x 5	25	gold-look	13,10
75832	7 x 5	25	copper-look	13,10



**Universalzange**  
all-purpose tongs  
pinza universal  
pince universelle



hochglanzpoliert, mit Befestigungsclip  
mirror polished, with fastening clip  
pulido brillante, con clip de fijación  
poli brillant, avec clip de fixation

	→ cm	Farbe / Colour	€
75850	19,5	mirror polished	4,20
75851	19,5	copper-look	4,60
75852	19,5	gunmetal-look	4,60



Zange kann an einer Schale befestigt werden  
tongs can be attached to a bowl



**Eiszange**  
ice tongs  
pinzas para hielo  
pince de la glace



hochglanzpoliert, mit Befestigungsclip  
mirror polished, with fastening clip  
pulido brillante, con clip de fijación  
poli brillant, avec clip de fixation

	→ cm	Farbe / Colour	€
75853	20	mirror polished	4,60
75854	20	copper-look	5,00
75855	20	gunmetal-look	5,00



Zange kann an einer Schale befestigt werden  
tongs can be attached to a bowl



**Universalzange**

all-purpose tongs  
pinza universal  
pinces universelle

**Edelstahl, Antik-Edelstahl-Look / Vintage-Look**

stainless steel, stainless antique look  
acero inoxidable, acero estilo antiguo  
acier inox, acier style antique



	cm	→ cm	Farbe / Colour	€
75823	5,5 x 5,0	20,0		8,00
75824	7,0 x 5,0	22,5		9,00



**Vorspeisenzange „BANQUET“**

appetizer tongs  
pinza para aperitivos  
pinces à apéritif

**Vorderteil poliert, Stiel mattiert**

front part: high-shiny, handle: matt-finish  
parte delantera pulida, asa mate  
partie avant polie, poignée matte



	cm	→ cm	€
75822	4,5 x 3,5	20	8,90



ideal für Vorspeisen  
ideal for starters



**Salatzange**

salad tongs  
pinza ensalada  
pinces à salade

**hochglanzpoliert, beidseitig geschlitzt / mirror polished, slotted on both side**  
pulido brillante, agujereada en 2 lados / poli brillant, perforéedes 2 côtés



	cm	→ cm	€
75801	5 x 2	24	6,30



**Spaghettizange**

spaghetti tongs  
pinza espaguetis  
pinces à spaghettis

**hochglanzpoliert, fugenlos**

mirror polished, seamless  
pulido brillante, sin soldaduras  
poli brillant, monobloc



	cm	→ cm	€
75810	6 x 3	19	4,80



**Gebäckzange**

pastry tongs  
pinza para pasteles  
pinçe à gâteaux

**hochglanzpoliert, fugenlos, extra schwere Qualität**

mirror polished, seamless, extra heavy gauge  
pulido brillante, sin soldadura, alta calidad, resistente  
poli brillant, monobloc, qualité extra, robuste



	cm	→ cm	€
75807	8,5 x 4	27,5	9,70



**Universalzange**

all - purpose tongs  
pinza universal  
pinçe universelle

**hochglanzpoliert, einseitig geschlitzt**

mirror polished, slotted on one side  
pulido brillante, agujereada en un lado  
poli brillant, perforée d'un seul côté



	cm	→ cm	€
75800	5 x 2	24	5,00



**Allzweckzange**

multipurpose tongs  
pinza multi-usos  
pinçe universelle multi-usages

**hochglänzend, mit Feder und Verschlusschieber, dekorative Greiferform**

mirror polished, with spring and retaining clip, decorative gripper form  
pulido brillante, con muelle y cierre deslizante, gancho con forma decorativa  
poli brillant, avec mécanisme de verrouillage, forme de pinçe décorative



	cm	→ cm	€
88643	4 x 3	24	3,70
88644	4 x 3	30	4,50
88645	4 x 3	40	4,90



**Aufschnitt- / Allzweckzange**

sausage tongs  
pinza salchichas  
pinçe à saucisses

**hochglanzpoliert, fugenlos**

mirror polished, seamless  
pulido brillante, sin soldadura  
poli brillant, monobloc



	cm	→ cm	€
75806	3 x 2,5	16	4,00



**Salatzange „TIDLOS“**

salad tongs  
pinza ensalada  
pince à salade

hochglanzpoliert, einseitig geschlitzt  
mirror polished, slotted on one side  
pulido brillante, agujereada en un lado  
poli brillant, perforée d'un seul côté



	cm	→ cm	€
75842	5 x 2	22	6,20



**Pastazange „TIDLOS“**

pasta tongs  
pinza espaguetis  
pince à spaghettis

hochglanzpoliert, beidseitig geschlitzt  
mirror polished, slotted on both side  
pulido brillante, agujereada en 2 lados  
poli brillant, perforéedes 2 côtés



	cm	→ cm	€
75843	8 x 5,5	22,5	6,20



**Spargelzange „TIDLOS“**

asparagus tongs  
pinzas para espárragos  
pince à asperges

hochglanzpoliert / mirror polished / pulido brillante / poli brillant



	cm	→ cm	€
75844	7 x 11	24,5	6,90



**Gebäckzange „TIDLOS“**

pastry tongs  
pinza para pasteles  
pince à gâteaux

hochglanzpoliert / mirror polished / pulido brillante / poli brillant



	cm	→ cm	€
75840	6,5 x 4,5	21	4,40



**Servierzange „TIDLOS“**

serving tongs  
pinza universal  
pince universelle

hochglanzpoliert / mirror polished / pulido brillante / poli brillant



	cm	→ cm	€
75841	7 x 4,5	21	5,20



**Salatzange**

salad serving tongs  
pinza de ensalada  
pinçe à servir la salade

**hochglanzpoliert, einfache Handhabung**

mirror polished, convenient handling  
pulido brillante, manejo cómodo  
poli brillant, manipulation aisée



	cm	→ cm	€
00685	7,0 x 4,5	25	16,40



**Universalzange**

all - purpose tongs  
pinzas multiusos  
pinçe multi-usages

**hochglanzpoliert, einfache Handhabung**

mirror polished, convenient handling  
pulido brillante, manejo cómodo  
poli brillant, manipulation aisée



	cm	→ cm	€
00688	7,0 x 4,5	25	16,40



**Brot- und Gebäckzange**

bread and pastry tongs  
pinza para pan y bollería  
pinçe à pain ou viennoiseries

**hochglanzpoliert, einfache Handhabung**

mirror polished, convenient handling  
pulido brillante, manejo cómodo  
poli brillant, manipulation aisée



	cm	→ cm	€
00686	7,0 x 4,5	25	16,40



**Brot- und Gebäckzange**

bread and pastry tongs  
pinza para pan y bollería  
pinçe à pain ou viennoiseries

**hochglanzpoliert, einfache Handhabung**

mirror polished, convenient handling  
pulido brillante, manejo cómodo  
poli brillant, manipulation aisée



	cm	→ cm	€
00687	7,0 x 4,5	25	16,40



**Gebäckzange**

pastry tongs  
pinza para pasteles  
pinçe à gâteaux

hochglanzpoliert, perforiert  
mirror polished, perforated  
pulido brillante, perforado  
poli brillant, perforée



	cm	→ cm	€
75804	6,5 x 3	19,5	8,40



**Gebäck- / Tortenzange**

pastry tongs  
pinza para pasteles  
pinçe à gâteaux

hochglanzpoliert, fugenlos  
mirror polished, seamless  
pulido brillante, sin soldadura  
poli brillant, monobloc



	cm	→ cm	€
75803	7 x 3,5	17,5	5,40



**Eisportionierer**

ice cream scoop  
cuchara para helado  
cuillère à glace

hochglanzpoliert, mit Edelstahlfeder (physikalisch bedingt nicht korrosionsbeständig)  
mirror polished, spring steel, spring is not stainless  
pulido brillante, muelle de acero especial, no resistente al óxido  
poli brillant, ressort acier spécial, non résistant à l'oxydation



	Ø cm	→ cm	ltr.	€
71006	6,5	23,5	1/12	11,60
71005	6,0	22,5	1/16	11,60
71004	5,5	22,0	1/20	11,60
71003	5,0	22,0	1/24	11,60
71002	5,0	21,5	1/30	11,60
71001	4,5	21,0	1/36	11,60

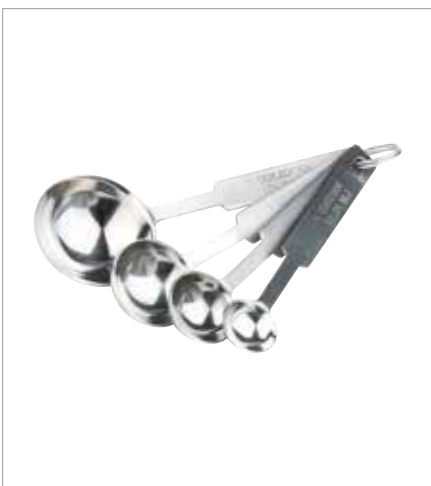

**Messlöffelsatz**

set measuring spoon  
juego de cucharas medidoras  
jeu de cuillère à mesure

Löffel hochglanzpoliert, Stiele matt poliert, Skalierung:  
1 Esslöffel, 1 Teelöffel, 1/2 Teelöffel, 1/4 Teelöffel

bowl mirror polished, handles matt polished, measures:  
table spoon, tea spoon, 1/2 tea spoon, 1/4 tea spoon

bol medidor brillante, mango mate medidas:

1 cuchara de sopa, 1 cuchara de té, 1/2 cuchara de té, 1/4 cuchara de té

corps brillant, manche mat, mesures:

1 cuillerée à soupe, 1 cuillerée à thé, 1/2 cuillère à thé, 1/4 de cuillère à thé



	cm	€
75600	14 x 4,5	6,70





**Pinzettenzange**

fine tongs / tweezer  
pinza de emplatar  
pince à dresser

**hochglanzpoliert, geriffelte Grifffläche, schwere Qualität**

mirror polished, ribbed handle, heavy gauge  
pulido brillante, mango cómodo ranurado, alta calidad  
poli brillant, manche rainuré antiglisse, qualité extra



	→ cm	€
75820	16	6,60



**Pinzettenzange**

fine tongs / tweezer  
pinza de emplatar  
pince à dresser

**hochglanzpoliert, geriffelte Grifffläche, schwere Qualität**

mirror polished, ribbed handle, heavy gauge  
pulido brillante, mango cómodo ranurado, alta calidad  
poli brillant, manche rainuré antiglisse, qualité extra



	→ cm	€
75821	30	9,90



**Pinzettenzange**

fine tongs / tweezer  
pinza de emplatar  
pince à dresser

**hochglanzpoliert, geriffelte Grifffläche, schwere Qualität**

mirror polished, ribbed handle, heavy gauge  
pulido brillante, mango cómodo ranurado, alta calidad  
poli brillant, manche rainuré antiglisse, qualité extra



	→ cm	€
75809	30	8,40



**Pinzettenzange**

fine tongs / tweezer  
pinza de emplatar  
pince à dresser

**hochglanzpoliert, geriffelte Grifffläche, abgerundete Spitzen vorne, schwere Qualität**

mirror polished, ribbed handle, rounded on the tops, heavy gauge  
pulido brillante, mango cómodo ranurado, alta calidad, puntas redondeadas  
poli brillant, manche rainuré antiglisse, qualité extra, pointes arrondies



	→ cm	€
75808	14,5	5,50

# TOOLTIME



## Kugelausstecher - doppelt „TOOLTIME“

melon baller - double  
vaciador doble de bola  
moule à boule double



zum Formen von Kugeln aus Obst, Gemüse oder Butter, Edelstahl mit geschärften Rändern  
to form balls out of fruits, vegetables, butter, etc., stainless steel with sharpened edge  
para hacer bolas con frutas, verduras, mantequilla, etc. acero inoxidable con borde afilado  
pour faire des boules de fruits, légumes, beurre, etc. inox, bord affûté

	∅ cm	→ cm	€
88810	2,2 + 2,5	16,5	7,50
88811	2,2 + 3,0	17	7,60



## Fadenschneider / Zester „TOOLTIME“

decorator / zester  
cuchillo de decoración cincelador  
couteau zesteur



zum Abziehen von feinsten Schalenstreifen, ideal zum Dekorieren von Torten und Desserts  
to peel off very fine stripes of paring, these stripes are ideal to decorate desserts, cakes, etc.  
para pelar tiras muy finas, ideal para decorar postres, tartas, etc.  
pour couper en lanières fines, idéal pour la décoration de gâteaux et desserts, etc.

	∅ cm	→ cm	€
88823	0,2 + 0,5	14,5	4,20



**Ziseliermesser „TOOLTIME“**

canele / decorating knife  
cuchillo de decoración cincelador acanalado  
couteau zesteur cannelé



zum Einritzen von Linien und Mustern in hartschaliges Obst und Gemüse, Edelstahl mit geschärften Rändern

to score lines or design in hard fruits and vegetables, stainless steel with sharpened edge  
para dibujar líneas en frutas o verduras de piel dura, acero inoxidable con borde afilado  
pour découper des lignes et motifs sur fruits et légumes à peau dure ou pour peler les zestes des citrons ou oranges, inox, bord affûté

	→ cm	€
88826	15	4,20



**Sparschäler „TOOLTIME“**

peeler  
pelador  
peleur



für Links- und Rechtshänder geeignet, mit zwei starren Klingen aus extra geschärftem + gehärtetem Edelstahl

useable left- and right handed, with 2 inflexible blades made out off sharpened, extra hardened stainless steel

para diestros y zurdos, con 2 cuchillas rígidas inox afiladas y muy resistentes  
pour gauchers ou droitiers, 2 lames rigides affûtés en inox extra-résistant

	→ cm	€
88827	17	2,80



**Pendelschäler „TOOLTIME“**

swivel peeler  
pelador reversible  
éplucheur droitier/gaucher



für Links- und Rechtshänder, ideal für das Schälen von Tomaten, mit 2 beweglichen Klingen

suitable for right and left handed, ideal to peel tomatoes, with 2 flexibles blades

apto para diestros y zurdos, ideal para pelar tomates, con 2 hojas flexibles

pour gauchers ou droitiers, idéal pour peler les tomates, 2 lames flexibles

	→ cm	€
88850	16,5	4,60



**Cocktailmesser „TOOLTIME“**

bar knife  
cuchillo para cóctel  
couteau cocktail



mit 2 Zinken zum Aufspießen von Zitrusseiben

with 2 prongs to pick up slices of lemon

con 2 dientes para pinchar las rodajas de limón, etc.

avec 2 dents pour les rondelles de citron et autres décorations

	→ cm	€
88846	21	4,80



**Pizzateigschneider „TOOLTIME“**

pizza cutter  
cortador de pizza  
roulette à pizza

zum einfachen Zerteilen von Pizza  
to cut pizza easily  
para cortar pizza fácilmente  
pour une coupe facile de la pizza



	Ø cm	→ cm	€
88829	6	18,5	4,80



**Pendelschäler „TOOLTIME“**

swivel peeler  
pelador lama pivotante  
peleur lame pivotante

zum schnellen und sparsamen Schälen von Obst und Gemüse, mit beweglicher Klinge  
to peel fruits and vegetables with flexible blade  
para pelar frutas y verduras con hoja flexible  
pour couper des fruits et légumes avec lame flexible



	→ cm	€
88834	17	5,20



**Apfelentkerner „TOOLTIME“**

apple corer  
descorazonador de manzana  
vide-pomme

durch leichtes Drehen kann das Kerngehäuse von Äpfeln, Birnen und anderen Früchten sorgsam herausgeholt werden, Edelstahl mit geschärften Rändern  
with a light turn cores of apples, pears and other fruits can be cut off easily, stainless steel with sharpened edge  
para descorazonar muy fácilmente manzanas, peras y otras frutas  
pour évider facilement les pommes, poires ou autres fruits



	Ø cm	→ cm	€
88836	2,2	21	3,30



**Austernöffner „TOOLTIME“**

oyster knife  
abre ostras  
couteau à huîtres

zum einfachen Aufbrechen von Austern, mit Fingerschutz, Edelstahl mit geschärften Rändern  
to open oysters easily, with guard, stainless steel with sharpened edge  
para abrir ostras fácilmente con protección para los dedos, acero inoxidable con punta afilada  
pour ouvrir facilement les huîtres avec protection pour les doigts, inox, pointe affûtée



	→ cm	€
88839	14,5	7,10

**Austernmesser „TOOLTIME“**

oyster knife  
 abre ostras  
 couteau à huîtres

**Edelstahl Klinge zum Einstechen in die Schale, mit Fingerschutz**

to open oysters easily, with guard

para abrir ostras fácilmente con protección para los dedos

pour ouvrir facilement les huîtres avec protection pour les doigts



→ cm

€

88840

15

4,10

**Dekoriermesser „TOOLTIME“**

decorating knife „cannelé“  
 cuchillo acanalador  
 couteau cannelé

**gezahnte Klinge aus geschärftem Edelstahl**

serrated sharpened blade, stainless steel

hoja de sierra afilada, acero inoxidable

lame inox microdentée



→ cm

€

88843

19

5,90

**Käsehobel „TOOLTIME“**

cheese slicer  
 rebanador de queso  
 couteau tranche-fromage

**zum Schneiden von dünnen Käsescheiben**

to cut thin slices of cheese

para cortar lonchas finas de queso

pour couper de fines tranches de fromage



→ cm

€

88853

21,5

5,90



**Streichpalette „TOOLTIME“**

spatula  
espátula  
spatule

**flexible Edelstahlklinge, rutschfester Griff, hitzebeständig**

flexible blade stainless steel, non-slip handle, heat-resistant

hoja flexible acero inoxidable mango polipropileno termoresistente anti-deslizante

lame inox flexible, manche antiglisse en polypropilène thermorésistant



	cm	→ cm	€
88920	35 x 5	48,5	9,70
88921	30,5 x 4,5	43,5	8,50
88922	25 x 4	38,0	7,80
88923	20 x 3	33,5	6,50



**Winkelpalette „TOOLTIME“**

spatula  
espátula  
spatule

**flexible Edelstahlklinge**

flexible blade stainless steel

hoja flexible acero inoxidable

lame inox flexible



	cm	→ cm	€
88928	17 x 5	30	6,80



**Gebäckpalette „TOOLTIME“**

pastry spatuala  
paleta pastelera  
spatule pâtissière

**flexible Edelstahlklinge**

flexible blade stainless steel

hoja flexible acero inoxidable

lame inox flexible



	cm	→ cm	€
88932	17 x 7,5	29,5	7,60



**Wender „TOOLTIME“**

turner  
espátula  
spatule

**flexible Edelstahlklinge**

flexible blade stainless steel

hoja flexible acero inoxidable

lame inox flexible



	cm	→ cm	€
88933	15 x 6	27,5	6,10



**Winkelpalette „TOOLTIME“**

turner  
espátula  
spatule

**flexible Edelstahlklinge**  
flexible blade stainless steel  
hoja flexible acero inoxidable  
lame inox flexible



	cm	→ cm	€
88935	34 x 5	47,5	9,90
88937	24 x 4	36	7,10
88938	18,5 x 3	32	6,40



**Wender „TOOLTIME“**

turner  
espátula  
spatule

**flexible Edelstahlklinge**  
flexible blade stainless steel  
hoja flexible acero inoxidable  
lame inox flexible



	cm	→ cm	€
88939	24 x 7,5	37,5	9,10



**Wender „TOOLTIME“**

turner  
espátula  
spatule

**perforiert, flexible Edelstahlklinge**  
perforated, flexible blade stainless steel  
hoja flexible inox agujereada  
lame ajourée inox flexible



	cm	→ cm	€
88940	24,5 x 7,5	37,5	9,40



**Wender „TOOLTIME“**

turner  
espátula para plancha  
spatule

**flexible Edelstahlklinge**  
flexible blade stainless steel  
hoja flexible acero inoxidable  
lame inox flexible



	cm	→ cm	€
88941	20 x 7,5	33	8,00
88942	15 x 9	28	7,90



**Spachtel / Schaber „TOOLTIME“**

scraper  
 espátula plancha  
 spatule coudée spéciale grill  
**starre Edelstahl Klinge**  
 rigid blade stainless steel  
 hoja rígida acero inoxidable  
 lame inox rigide



	cm	→ cm	€
88929	11 x 10	25	7,60



**Spachtel / Fettabstecher „TOOLTIME“**

scraper  
 espátula plancha  
 spatule coudée spéciale grill  
**starre Edelstahl Klinge**  
 rigid blade stainless steel  
 hoja rígida de acero inoxidable  
 lame rigide inox



	cm	→ cm	€
88946	17 x 10	30	9,10
88947	15 x 7,5	28	7,60



**Aufstrichmesser „TOOLTIME“**

sandwich knife  
 cuchillo para untar  
 couteau à tartiner  
**flexible Edelstahl Klinge**  
 flexible blade stainless steel  
 hoja flexible acero inoxidable  
 lame inox flexible



	cm	→ cm	€
88948	8,5 x 3	18,5	2,80



**Teigschaber / Abstecher „TOOLTIME“**

dough scraper  
 corta pasta  
 coupe-pâte  
**starre Edelstahl Klinge**  
 rigid blade stainless steel  
 hoja rígida de acero inoxidable  
 lame rigide inox



	cm	€
88930	15,5 x 8	5,20





**Pizzaschneider „TOOLTIME“**

pizza cutter  
cortador de pizza  
coupe-pizza

ergonomischer Griff  
ergonomic handle  
mango ergonómico  
manche ergonomique



	∅ cm	→ cm	€
88949	10	20	6,70



**Eierschneider**

egg cutter  
corta huevos  
coupe-oeufs

zum Längs- und Querteilen von hart gekochten Eiern  
to cut hard-boiled eggs  
corta a rodajas un huevo duro  
en rondelles



	cm	↑ cm	€
88099	14,5 x 8	2,5	2,50



**Hummerbrecher**

lobster cracker  
pinza bogavante  
pince à homard



	cm	€
74201	14 x 5,5	8,80



**Schneebeesen**

whisk  
batidor  
fouet



	Drähte / wires	→ cm	€
00744	8	28	6,60
00745	8	33	6,80
00746	8	38	8,40
00747	8	43	9,50
00740	8	48	10,00



## STRAINERS



### Passiersieb

strainer  
colador  
passoire



feines Siebgewebe mit ca. 6 Löchern pro 1 cm<sup>2</sup>

fine mesh with 6 holes per 1 cm<sup>2</sup>

malla fina con 6 agujeros por 1 cm<sup>2</sup>

toile fine avec 6 trous pour 1 cm<sup>2</sup>

	Ø cm	→ cm	€
88618	30,0	60,0	48,00
88639	33,5	62,5	51,00



### Passiersieb

strainer  
colador  
passoire



feines Siebgewebe mit ca. 6 Löchern pro 1 cm<sup>2</sup>

fine mesh with 6 holes per 1 cm<sup>2</sup>

malla fina con 6 agujeros por 1 cm<sup>2</sup>

toile fine avec 6 trous pour 1 cm<sup>2</sup>

	Ø cm	→ cm	€
74700	14	30	7,60
74701	16	32	9,60
74702	18	34	12,40
74703	20	36	13,80
74705	24	41	15,80
74706	26	43	18,20



### Passiersieb, 3er Set

strainer, 3 pcs.  
colador, set de 3  
passoire, set de 3



3-teiliges Set bestehend aus 3 Sieben:

Ø 8,5 cm, L: 22,5 cm / Ø 14,5 cm, L: 32 cm / Ø 19,5 cm, L: 38,5 cm

set of 3 consisting of 3 sieves:

Ø 8,5 cm, L: 22,5 cm / Ø 14,5 cm, L: 32 cm / Ø 19,5 cm, L: 38,5 cm

set de 3 que consta de 3 tamices:

Ø 8,5 cm, L: 22,5 cm / Ø 14,5 cm, L: 32 cm / Ø 19,5 cm, L: 38,5 cm

set de 3 composé de 3 tamis :

Ø 8,5 cm, L: 22,5 cm / Ø 14,5 cm, L: 32 cm / Ø 19,5 cm, L: 38,5 cm

	Ø cm	→ cm	€ / set
74707	8,5/14,5/19,5	22,5/32/38,5	15,20

**Passiersieb**

strainer  
colador  
passoire



mit Doppelnetz, Netz außen: ca. 2 Löcher pro 1 cm, Netz innen: ca. 5 Löcher pro 1 cm  
with double mesh, outer mesh about 2 holes per cm, inner mesh about 5 holes per cm  
con malla doble, malla exterior aprox. 2 agujeros /cm, interior aprox. 5 agujeros /cm  
avec double étamine, extérieure env. 2 trous/cm, intérieure environ 5 trous/cm

	Ø cm	→ cm	€
74721	19,5	41,0	12,20
74722	24,5	56,5	19,00

**Barsieb**

bar strainer  
colador de cóctel  
tamis cocktail



	Ø cm	↑ cm	Griff / handle cm	€
93318	8,5	5	11,5	4,50

**Gazespitzsieb**

conical strainer with wire gauze  
colador chino de malla  
chinois renforcé avec maille fine



hochglanzpoliert, mit rundem Hohlgriff, ca. 9 Löcher pro 1 cm<sup>2</sup>  
mirror polished, 9 holes per 1 cm<sup>2</sup>  
pulido brillante, mango hueco, 9 agujeros por 1 cm<sup>2</sup>  
poli brillant, manche creux, 9 trous pour 1 cm<sup>2</sup>

	Ø cm	↑ cm	Griff / handle cm	€
88717	25	19	24	44,00

**Spitzsieb**

conical strainer  
colador cónico  
chinois



mit Lochung Ø 1,5 mm, auch in der Kegelspitze, mit Flachstiel, mit Stützstiel zum Einhängen in den Topfrand

with Ø 1,5 mm holes (including the tip), with flat handle, with supporting hook  
con agujeros finos de Ø 1,5 mm (incluida la punta), con mango plano y gancho  
perforations fines 1,5 y compris à la pointe, manche plat et crochet

	Ø cm	↑ cm	Griff / handle cm	€
00771	23	18	16,5	26,00

**Back- / Frittierlöffel**

skimmer / spider  
espumadera para fritos  
écumoire à friture



elektropoliert, sehr stabile Ausführung  
electro polished, heavy gauge  
electro pulido, alta calidad  
poli électrolythique, qualité extra

	Ø cm	→ cm	€
74402	16	48	19,40
74404	20	54	24,00

## STRAINERS



### Seiher strainer colador passoire

2 Griffe: je 2 cm / 2 handles: each 2 cm / 2 asa: 2 cm cada una / 2 poignées: 2 cm chacune



	Ø cm	↑ cm	Farbe / Colour	€
00786	27,5	12		8,00
00787	27,5	12		8,00



### Seiher strainer colador passoire

mit 2 Muschelgriffen / with 2 shell shaped grips / con dos asas / à 2 anses moulées



	Ø cm	↑ cm	€
00780	36	19	12,50



### Pommes-Frites-Seiher

fry dripping tray  
escurridor de fritos  
égouttoir à friture

herausnehmbarer Locheinsatz, mit Handgriff

removable drainer, with handle

fondo de colador desmontable, con asa

fond démontable, avec poignée



	Ø cm	↑ cm	€
00785	39	19	34,00



### Salzstreuer

salt shaker  
salero  
salière

Pommes-Frites Streuer mit Schraubkappe

for french fries, cover to screw

para patatas fritas, tapa de rosca

pour les frites, couvercle à visser



	Ø cm	↑ cm		€
00772	8	17	stainless steel	15,00
00779	8	17	aluminium	9,90



**Wasserbadschüssel**  
bain marie bailing bowl  
cazo para baño maría  
réceptier bain-marie



hochglanzpoliert, mit Drahtgriff Ø 5 mm  
mirror polished, with wire handle Ø 5 mm  
pulido brillante, mango varilla Ø 5 mm  
poli brillant, manche fil épaisseur Ø 5 mm

	Ø cm	↑ cm	Griff / handle cm	ltr.	€
74731	18	9	15	1,5	14,70



Anwendungsbeispiel, Topf ≥ 20 cm  
Application Example, pot ≥ 20 cm



**Saucen- und Fondanttrichter**  
sauce and confectionary funnel  
embudo para salsa y confitería  
entonnoir à sauce et confiserie



ergonomischer Griff, Maßskalierung innen, mit 3 Düsen Ø 4, 5, 6 mm, inklusive Ständer und Auffangschale

ergonomic handle, scaling inside, with 3 different nozzles Ø 4, 5, 6 mm, including wire rack a. dripping dash  
mango ergonómico, escalado interior, con 3 boquillas, Ø 4, 5, 6 mm, incl. pie de alambre y bandeja recoge gotas  
manche ergonomique, mise à l'échelle à l'intérieur, 3 douilles de Ø 4, 5 et 6 mm, inclut pied avec ramasse-gouttes

	Ø cm	↑ cm	ltr.	€
77338	21	31,5	1,5	98,00



Anwendungsbeispiel  
application example



Maßskalierung innen  
scaling inside



**Gemüsehobel, Mandoline**  
mandolin  
mandolina  
mandoline



mit 7 verschiedenen Klingen (Breite 10 cm), Anti-Rutsch-Gestell, Schutzabdeckung  
with 7 interchangeable blades (width 10 cm), non-slip folding stand, safety guard  
con 7 cuchillas intercambiables (corte 10 cm), pie plegable anti-deslizante, carro de seguridad  
7 peignes interchangeables (largeur 10 cm), pied repliable anti-glisse, chariot

	cm	↑ cm	€
88688	40,5 x 12	5 / 25	77,70



**A** 7 verschiedene Klingen  
7 interchangeable blades  
**B** Praktische Transportbox  
Practical transport box

## MEASURING CUPS

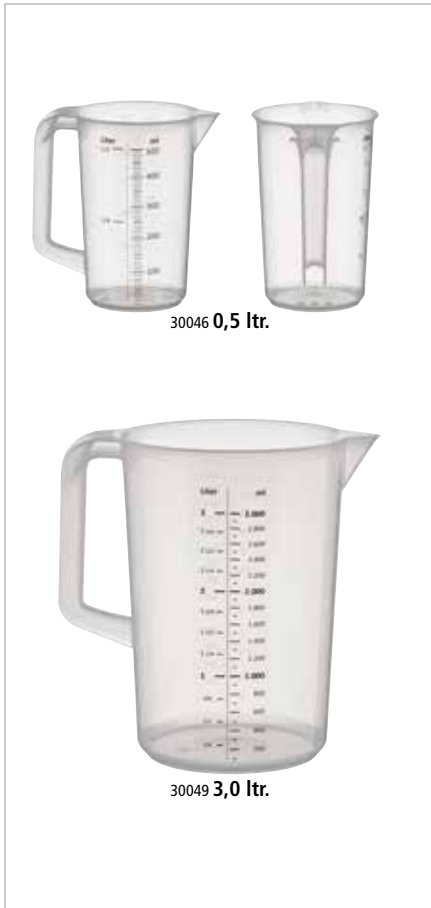

### Messbecher „PRO“

measuring cup  
jarra graduada  
pichet gradué



mit geschlossenem Griff, mit geprägter Maßskalierung außen, l- und ml-Liter-Einteilung  
with closed handle, with stamped printed liter and ml scale  
con asa cerrada, con escala estampada de litros y ml  
avec poignée fermée, avec échelle en litres et ml imprimée et tamponnée

	Ø cm	↑ cm	ltr.	€
30046	9	14	0,5	3,40
30047	12	16,5	1,0	4,50
30048	15	20,5	2,0	7,80
30049	17	23,5	3,0	10,00
30057	20	25,5	5,0	12,60



einfaches Eingießen  
easy pouring



### Messbecher „STACKABLE“

measuring cup  
jarra graduada  
pichet gradué



mit offenem Griff und geprägter Maßskalierung außen, platzsparend stapelbar  
with open handle and embossed dimension scaling on the outside, space-saving stackable  
con asa abierta y escala de dimensiones en relieve en el exterior, apilable para ahorrar espacio  
avec une poignée ouverte et une échelle de dimensions en relief à l'extérieur, empilable et peu encombrante

	Ø cm	↑ cm	ltr.	€
30059	7	12	0,25	2,50
30061	9	14	0,5	3,10
30062	12	16,5	1,0	4,10
30063	15	20,5	2,0	7,20



offener Griff  
open handle



einfaches Eingießen  
easy pouring



stapelbar  
stackable



30072 1 ltr.



30058 1 ltr.

inkl. Spritzschutz / incl. splash guard

**Rührbecher mit Deckel**  
 stirring cup with lid  
 vaso agitador con tapa  
 tasse à remuer avec couvercle



**inklusive Spritzschutz und geprägter Maßskalierung außen, platzsparend stapelbar**  
 included splash guard with open handle and embossed dimension scaling on the outside, space-saving stackable  
 protección contra salpicaduras incluida con asa abierta y escala de dimensiones en relieve en el exterior, apilable para ahorrar espacio  
 protection contre les éclaboussures incluse avec une poignée ouverte et une échelle de dimensions en relief à l'extérieur, empilable et peu encombrante

	Ø cm	↑ cm	ltr.	Farbe / Colour	€
30072 <small>new</small>	12,5	16	1,0		7,40
30058	12,5	16	1,0		7,40



Griff mit Daumenmulde  
 handle with thumb recess



mit Silikonring  
 with silicone ring



inklusive Spritzschutz  
 incl. splash guard



1 ltr.



**Messbecher**  
 graduated jug  
 jarra graduada  
 pichet gradué

**außen hochglanzpoliert, innen matt poliert, mit Maßskalierung außen**  
 outside mirror polished, inside matt polished, with stamped liter scale  
 exterior pulido brillante, interior pulido mate con escalado en litros  
 extérieur poli brillant, intérieur poli mat, graduation en litres

	Ø cm	↑ cm	ltr.	€
30045	10	14	1	13,40



30075 10,5 ltr.



30078 17 ltr.

**Profi-Eimer**  
 bucket  
 cubo  
 seau



**mit Ausgießer und geprägter Maßskalierung innen**  
 with spout and embossed dimension scaling inside  
 con pico y escala de medición en relieve en el interior  
 avec bec verseur et échelle de mesure en relief à l'intérieur

	Ø cm	↑ cm	ltr.	Farbe / Colour	€
30075	28,5	28,5	10,5		12,90
30076	33,0	32,0	17,0		16,50
30077	28,5	28,5	10,5		12,90
30078	33,0	32,0	17,0		16,50



mit Griff  
 with handle



Maßskalierung innen  
 dimension scaling inside



Auslaufnase für sicheres Handling  
 discharge nose for safe handling

## CAKE SETTING RINGS



### Backform

baking pan  
marco pastelero  
forme à gateaux

**stufenlos verstellbar, aus flexiblem Edelstahl**

adjustable, made of flexible stainless steel  
ajustable, de acero inoxidable flexible  
ajustable, en acier inox flexible



	cm	↑ cm	€
00042	19 x 28 - 34 x 54	5	17,90



Anwendungsbeispiel  
application example



### Tortenring

cake setting ring  
aro de tarta  
cercle à gâteaux

**stufenlos verstellbar, ohne Griff**

adjustable, without handle  
ajustables, sin asa  
ajustables, sans poignée



	Ø cm	↑ cm	€
00040	16,5 - 32	7	8,70



Anwendungsbeispiel  
application example



### Schaumpeisering

mousse ring  
aro redondo para semifríos  
cercle à mousse rond

**matt poliert, fugenlos**

matt polished, seamless  
pulido mate, sin soldadura  
poli mat, sans soudure



	Ø cm	↑ cm	€
00098	6	4,5	3,20
00099	7	4,5	3,70
00092	8	4,5	3,80
00093	10	4,5	5,30
00094	12	4,5	7,00



### Schaumpeiseringe, 5er Set

mousse ring, 5 pcs.  
juego aros para emplatar o para semifríos  
jeu de cercles à mousse inox, ronds

**5-teilig: 4 Formen + 1 Verdichter, matt poliert, fugenlos**

5 pcs. set: 4 shapes and 1 pusher, matt polished, seamless

juego de 5 piezas: 4 aros redondos y 1 pulsador, para dar forma, satinado sin soldadura  
jeu de 5 pièces: 4 cercles et 1 poussoir. Idéal pour dressage sur assiette ou mousse, poli mat, sans soudure



	Ø cm	↑ cm	pcs.	€ / set
00110	6	4,5	5	17,60
00113	8	4,5	5	19,00





**Dariolformen, 2er Set**

dariol moulds, 2 pcs.  
juego 2 flaneras  
jeu de 2 moules à flan



**hochglanzpoliert**  
mirror polished  
pulido brillante  
poli brillant

	Ø cm	↑ cm	ltr.	pcs.	€ / set
00106	6,5	4,5	0,1	2	5,50



**Ausstellblech / Thekenblech**

display tray  
bandeja pastelera  
plaque pâtissière



**hitzebeständig bis 230°C**  
heat-resistant up to 230°C  
resistente al calor hasta 230 °C  
résistant à la chaleur jusqu'à 230°C

	cm	↑ cm	€
13377	40 x 25	2	12,40
13378	48 x 32	2	14,50
13379	60 x 40	2	18,80



**Teigspatel / Stielschaber**

dough spatula / handle scraper  
espátula masa / rascador  
spatule à pâte / raclette



**Aufhängeloch**  
with hanging hole  
con agujero para colgar  
avec trou de suspension

	→ cm	Farbe / Colour	€
88950	25,5	White	10,00
88951	35,5	White	12,00



Trichter „PROFI“  
 funnel  
 embudo  
 entonnoir  
 mit Öse  
 with eyelet  
 con ojal  
 avec œillet



	Ø cm	Ø mm Durchlass		€
30065	6	8		1,10
30066	8	11		1,30
30067	10	12		1,50
30068	12	12		2,20
30069	14	15		4,40
30070	17	17	mit Sieb / with strainer	6,20
30071	21	20	mit Sieb / with strainer	7,60



erleichtert das Einfüllen  
 facilitates filling



Anwendungsmöglichkeit  
 applicability



mit einsetzbarem Sieb  
 with insertable strainer



mit einsetzbarem Sieb  
 with insertable strainer



**Mehlschaufel „PRO“**

scoop  
pala  
pelle à farine

**stehende Schaufel, auch für Flüssigkeiten geeignet**

standing scoop, also applicable for liquids

pala, ápto también para líquidos

adaptée pour poudres et liquides



	cm	↑ cm	ltr.	Farbe / Colour	€
00610	25 x 9	4,5	0,25		2,90
00611	31 x 12	5,5	0,5		3,50
00612	35 x 13	6	0,7		5,10



**Schaufel „ECO“**

scoop  
pala  
pelle

**stabil und bruchsicher**

stable and unbreakable

estable e irrompible

stable et incassable



	→ cm	ltr.	€
00694	18	0,110	1,40
00695	24	0,230	1,70
00696	31	0,470	2,10
00697	33	0,725	3,30



**Zum schnellen und zielgerichteten Abfüllen von Lebensmitteln**

for fast and targeted filling of foodstuffs

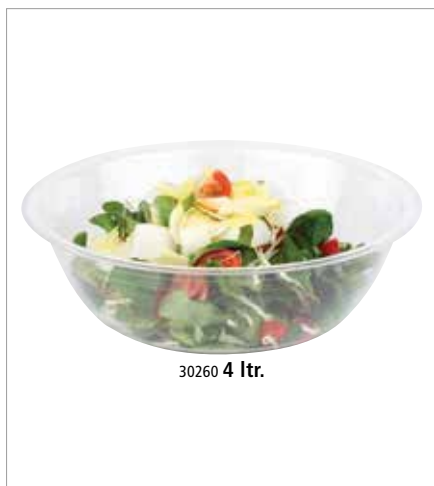

**Schüssel**

bowl  
ensaladera  
saladier

**glasklar**

crystal clear

cristalina

transparent

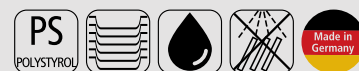

	Ø cm	↑ cm	ltr.	Farbe / Colour	€
30260	32,5	10	4		5,10
30263	40	12	8		10,40



# SQUEEZE BOTTLES



## Quetschflasche

squeeze bottle  
bote dosificador flexible  
bouteille verseuse souple

mit Schraubdeckel und Verschlusskappe, ideal für Dressing und Saucen

with tight-screw and cap, ideal for dressing and sauce

con tapa de rosca y tapón, ideal para aliño y salsas

avec couvercle à visser et bouchon de fermeture, idéal pour vinaigrette et sauces



	Ø cm	↑ cm	ltr.	Farbe / Colour	€
93259	8	26,5	1,025		2,30
93260	8	26,5	1,025		2,30
93261	8	26,5	1,025		2,30



große Öffnung  
big mouth opening



## Quetschflasche

squeeze bottle  
bote dosificador flexible  
bouteille verseuse souple

mit Schraubdeckel und Verschlusskappe, ideal für Dressing und Saucen

with tight-screw and cap, ideal for dressing and sauce

con tapa de rosca y tapón, ideal para aliño y salsas

avec couvercle à visser et bouchon de fermeture, idéal pour vinaigrette et sauces



	Ø cm	↑ cm	ltr.	Farbe / Colour	€
93155	6,5	24	0,65		1,90
93156	6,5	24	0,65		1,90
93157	6,5	24	0,65		1,90



## Quetschflasche „MINI“, 4er Set

squeeze bottle, 4 pcs.  
bote dosificador flexible, 4 pz.  
bouteille verseuse souple, 4 pc.

mit Schraubdeckel und Verschlusskappe, ideal für Dressing und Saucen

with tight-screw and cap, ideal for dressing and sauce

con tapa de rosca y tapón, ideal para aliño y salsas

avec couvercle à visser et bouchon de fermeture, idéal pour vinaigrette et sauces



	Ø cm	↑ cm	ltr.	pcs.	€ / set
93225	3,0	8,5	0,03	4	5,50
93226	3,5	9,5	0,05	4	5,90



**Quetschflasche, 6er Set**

squeeze bottle, 6 pcs.  
bote dosificador flexible, set de 6  
bouteille verseuse souple, set de 6



**mit Schraubdeckel und Verschlusskappe, ideal für Dressing und Saucen**

with tight-screw and cap, ideal for dressing and sauce  
con tapa de rosca y tapón, ideal para aliño y salsas  
avec couvercle à visser et bouchon de fermeture, idéal pour vinaigrette et sauces

	Ø cm	↑ cm	ltr.	Farbe / Colour	pcs.	€/ set
93250	5	18,0	0,26		6	7,40
93251	5	18,0	0,26		6	7,40
93252	5	18,0	0,26		6	7,40
93253	7	20,0	0,49		6	10,20
93254	7	20,0	0,49		6	10,20
93255	7	20,0	0,49		6	10,20
93256	7	26,5	0,76		6	11,60
93257	7	26,5	0,76		6	11,60
93258	7	26,5	0,76		6	11,60



mit Verschlusskappe  
with cap



große „Öffnung“  
big „mouth opening“



**Quetschflasche „NON DRIP“**

squeeze bottle  
bote dosificador flexible  
bouteille verseuse souple



**mit Schraubdeckel, ideal für Dressing und Saucen**

with tight-screw, ideal for dressing and sauce  
con tapa de rosca, ideal para aliño y salsas  
avec couvercle à visser, idéal pour vinaigrette et sauces

	Ø cm	↑ cm	ltr.	Farbe / Colour	€
93270	5,5	21,0	0,35		3,90
93271	5,5	21,0	0,35		3,90
93272	5,5	21,0	0,35		3,90
93273	7,0	25,5	0,75		4,90
93274	7,0	25,5	0,75		4,90
93275	7,0	25,5	0,75		4,90



mit Skalierung  
with scalling



tropffrei  
non drip



**Quetschflasche**

squeeze bottle  
bote dosificador flexible  
bouteille verseuse souple



**ideale Größe, um Speiseteller mit Saucen zu verzieren, mit Verschlusskappe**

ideal size to garnish plates with sauces, with cap  
tamaño ideal para decorar platos con salsas, con tapón  
taille idéale pour décorer assiettes avec des sauces, avec bouchon

	Ø cm	↑ cm	ltr.	€
93154	5	16	0,2	1,50
93163	6	21	0,35	2,40



**Dosierspender**  
dispenser  
dispensador de salsa  
doseur à sauce



	cm	↑ cm	ltr.	GN	€
93280	17,6 x 16,2	27	2,6	1/6	26,00

**Dosierpumpe, Hubvolumen 30 ml**  
dosing pump / riser tube, swept volume 30 ml  
bomba de salsa, sola, cada dosis 30 ml  
pompe à sauce, 30 ml par dose



	cm	↑ cm	ltr.		€
93281	12,5 x 4,5	26	0,30	fits to 93280	18,00



**Dosierpumpe**  
dosing pump / riser tube  
bomba de salsa, sola  
pompe à sauce



Hubvolumen 30 ml / swept volume 30 ml / cada dosis 30 ml / 30 ml par dose

	Ø cm	↑ cm		€
88271	4,5	40		11,10



**Eier-Box**  
eggs box  
caja para huevos  
boîte à oeufs



mit luftdichtem Deckel, für 4 Lagen à 30 Eier, Lieferung inkl. 8 Lagen, Größe Lage: 28 x 28 cm  
with airtight cover, capacity: 4 trays of 30 eggs, delivery with 8 trays, size of tray: 28 x 28 cm  
capacidad para 4 bandejas de 30 huevos, tapa hermética, se entrega con 8 bandejas, formato bandejas 28 x 28 cm, apto para lavavajillas  
pour 4 plateaux de 30 oeufs chacun, apte pour 4 plateaux plats, couvercle hermétique, livré avec 8 plateaux, dimension plateau 28x28 cm, lavable en lave-vaisselle

	cm	↑ cm	GN	€
82419	35,4 x 32,5	20	2/3	39,90

10 Lagen / 10 trays / 10 bandejas / 10 plateaux

				€
82420				26,00



**Aufsteller „ACHTUNG RUTSCHGEFAHR“**  
stand  
letrero  
panneau



	cm	↑ cm		€
71421	30 x 63	63		8,90



**Limetten- / Zitronenpresse**

lime- / lemonpress  
 exprimidor de limón / lima  
 presse citron

2 Pressringe für Zitrone und Limette

2 squeezing rings for lemon and lime

2 anillos exprimidores para limón y lima

2 anneaux à presser pour le citron et le lime



	cm	↑ cm	€
93214	21 x 7	5	14,60



**Limettenpresse**

lime press  
 prensa de limón  
 presse citron



	cm	↑ cm	€
93189	21 x 7	5	11,40



**Zitruspresse**

citrus squeezer  
 exprimidor cítricos  
 presse-citron

hochglanzpoliert, 2-teilig

mirror polished, 2 pcs.

pulido brillante, 2 piezas

poli brillant, 2 pièces



	Ø cm	↑ cm	ltr.	€
71431	12 / 17	10,5	0,35	13,80

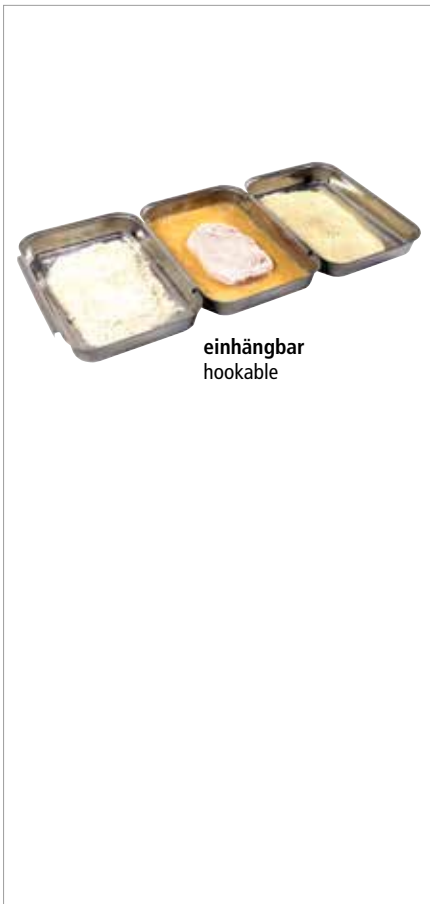

**Panierstation, 3-teilig**

breeding set, 3 pcs. set  
 estación de empanado, set de 3  
 station de panure, set de 3

zum Panieren von Fleisch, Gemüse, Käse etc.

for breading meat, vegetables, cheese etc.

para empanar carne, verduras, queso, etc.

pour paner la viande, les légumes, le fromage etc.



	cm	↑ cm	€/ set
66904	45,5 x 18	2,5	14,00



# PIZZA PANS



9 sizes



**Pizzaform**  
pizza pan  
molde de pizza  
moule à pizza



**Blaublech, nicht beschichtet, lange Lebensdauer, hitzebeständig bis 360 °C**  
blue steel, without coating, long endurance, heat resistant up to 360 °C  
chapa azul, sin revestimiento, larga vida útil, resistente al calor hasta 360 °C  
métal, sans revêtement, longue durée de vie, à la chaleur jusqu'à 360 °C

	∅ cm	↑ cm	€
73502	16 - 18	2,5	4,00
73505	22 - 24	2,5	6,70
73506	24 - 26	2,5	7,20
73507	26 - 28	2,5	7,50
73508	28 - 30	2,5	7,90
73509	30 - 32	2,5	8,40
73510	34 - 36	2,5	8,60
73511	38 - 40	2,5	10,40
73513	48 - 50	3,0	15,50



stapelbar  
stackable



**Pizzaform**  
pizza pan  
molde de pizza  
moule à pizza



**Blaublech, rechteckig, Rand umgelegt, hitzebeständig bis 360 °C**  
blue steel baking sheet, rectangular, heat resistant up to 360 °C  
chapa azul rectangular, borde plgado, resistente al calor hasta 360 °C  
métal, rectangulaire, bord plié, à la chaleur jusqu'à 360 °C

	cm	↑ cm	€
88256	60 x 40	2,5	26,00





**Gestell für Pizzaformen**

rack for pizza pans  
rejilla para pizzas  
support pour moules à pizza



**Edelstahlgestell zusammenklappbar für Pizzaformen Ø 28 cm, Abstand zwischen den Ebenen 5,5 cm**

foldable stainless steel rack for pizza dishes ø 28 cm, distance between the levels 5.5 cm  
rejilla plegable de acero inoxidable para moldes de pizza de Ø 28 cm, distancia entre los niveles 5,5 cm  
support en acier inox pliable pour les moules à pizza de Ø 28 cm, distance entre les niveaux 5,5 cm

	cm	↑ cm	€
73515	26 x 25	26	7,60



Backofen geeignet  
suitable for oven



Pizzaform für Ø 28 cm  
pizza dish for Ø 28 cm

**Pizzaform**  
pizza pan  
molde de pizza  
moule à pizza



	Ø cm	↑ cm	mm	€
73507	26 / 28	2,5	1	7,50



**Pizzaschaufel**

pizza peel  
pala de pizza  
pelle à pizza



	cm	→ cm	€
88080	35 x 30,5	90	39,20
88081	35 x 30,5	130	47,30

## PIZZA



### Pizzaschneider „TOOLTIME“

pizza cutter  
cortador de pizza  
coupe-pizza

ergonomischer Griff  
ergonomic handle  
mango ergonómico  
manche ergonomique



	∅ cm	→ cm	€
88949	10	20	6,70



### Korkuntersetzer

cork mat  
salvamanteles  
dessous-de-plat liège

ideal für Servier- und Eisenpfannen  
ideal for iron pan  
ideal para servir en sartenes de chapa  
idéal pour présenter les poêles forgées sur table



	∅ cm	↑ cm	€
73750	24	2	14,20



### Backhandschuhe

baking mittens  
manoplas de panadero  
gants de boulanger

Leder, gefüttert, Einheitsgröße, mit Stulpen, extrem hitzebeständig bis 250°C  
leather, inner lining, one size, with cuffs, extremely heat resistant up to 250°C  
cuero interior forrado, talla única, resiste a temperaturas hasta 250°C  
cuir intérieur doublé, taille unique, résiste à maxi 250°C

	→ cm	€
88090	45	28,00



### Teig- und Pizzaballenbehälter

dough and pizza ball container  
recipiente para masa y bolas de pizza  
récipient à pâte et boules à pizza

Innenmaß 56,5 x 36,5 cm, H: 6,5 cm  
inner dimension 56,5 x 36,5 cm, H: 6,5 cm  
medida interior 56,5 x 36,5 cm, H: 6,5 cm  
dimension intérieure 56,5 x 36,5 cm, H: 6,5 cm



	cm	↑ cm	ltr.	€
82440	60 x 40	7	13	12,00



stapelbar  
stackable

passender Deckel / fitting lid / tapa adecuada / couvercle approprié

	cm	↑ cm	€
82441	60 x 40	1	10,00



**Feinkost- / Olivenlöffel, 6er Set**  
 delicatessen / olives spoon, 6 pcs.  
 cuchara gourmet / para aceitunas, set de 6  
 cuillère gourmet / à olives, set de 6



**gelocht**  
 perforated  
 perforadas  
 perforées

	cm	→ cm	pcs.	Farbe / Colour	€ / set
88598	6 x 9	27	6	■	12,00



**Feinkostlöffel, 6er Set**  
 delicatessen spoon, 6 pcs.  
 cuchara gourmet, set de 6  
 cuillère gourmet, set de 6



**aus Kunststoff**  
 plastic  
 plástico  
 plastique

	Ø cm	→ cm	pcs.	Farbe / Colour	€ / set
88627	6	23	6	■	10,00
88628	6	23	6	■	10,00

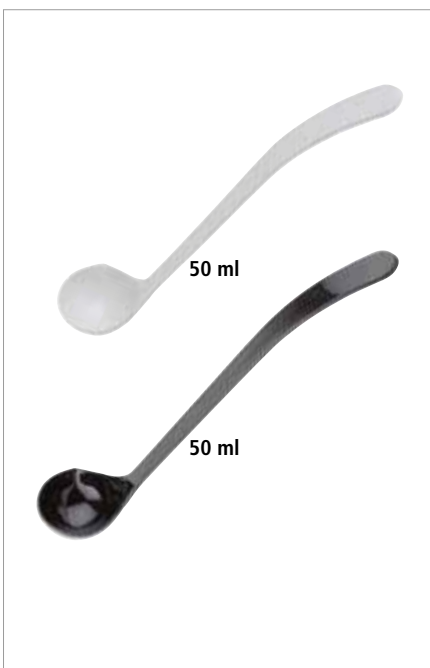

**Dressinglöffel**  
 dressing spoon  
 cuchara de aliño  
 cuillère à sauce



**aus Kunststoff**  
 plastic  
 plástico  
 plastique

	Ø cm	→ cm	ltr.	Farbe / Colour	€
88636	6	34	0,05	■	3,90
88609	6	34	0,05	■	3,90



**Salatbesteck „OLIVE“, 2er Set**

spoon, 2 pcs.  
cuchara, set de 2  
cuillère, set de 2

aus Olivenholz

olive wood  
madera de olivo  
en bois d'olivier



	cm	→ cm	€ / set
00841	9,5 x 8,5	17,0	17,30
00842	7,5 x 6,0	22,5	11,00



Anwendungsbeispiel  
application example



Anwendungsbeispiel  
application example



**Löffel „OLIVE“**

spoon  
cuchara  
cuillère

aus Olivenholz, ideal für Reis, Gemüse...

olive wood, ideal for rice, vegetables...  
madera de olivo, ideal para arroz, verduras...  
en bois d'olivier, idéal pour le riz, les légumes...



	cm	→ cm	€
00840	9,5 x 8,5	17,0	16,00



**Schaufel „OLIVE“**

scoop  
pala  
pelle

aus Olivenholz, ideal für Gewürze, Körner etc.

olive wood, ideal for spices, grains etc.  
madera de olivo, ideal para especias, granos etc.  
en bois d'olivier, idéal pour les épices, céréales, etc.



	→ cm	€
01020	13,5	7,40





**Löffel „OLIVE“, 2er Set**

spoon, 2 pcs.  
cuchara, set de 2  
cuillère, set de 2

aus Olivenholz, ideal für Gewürze  
olive wood, ideal for spices  
madera de olivo, ideal para especias  
en bois d'olivier, idéal pour les épices



	→ cm	pcs.	€ / set
01018	14	2	6,60



**Honiglöffel „OLIVE“**

honey spoon  
cuchara de miel  
cuillère à miel

aus Olivenholz  
olive wood  
madera de olivo  
en bois d'olivier



	→ cm	€
01019	15	4,90



**Löffel „ACACIA“**

spoon  
cuchara  
cuillère

aus Akazienholz, ideal für Reis, Gemüse...  
acacia wood, ideal for rice, vegetables...  
madera de acacia, ideal para arroz, verduras...  
bois d'acacia, idéal pour le riz, les légumes...



	cm	→ cm	€
00599	9 x 6,5	23,5	5,50



**Schaufel**

scoop  
pala  
pelle

aus geöltem Eichenholz, mit Kunstlederband, ideal für Gewürze, Körner etc.  
made of oiled oak wood, with leatherette strap, ideal for spices, grains etc.  
de madera de roble aceitada, con correa de polipiel, ideal para especias, granos etc.  
en bois de chêne huilé, avec bracelet en simili-cuir, idéal pour les épices, céréales, etc.



	cm	↑ cm	€
01026	25,5 x 6	4,5	14,00



Anwendungsbeispiel  
application example



**Bonspieß**

bill spike  
pinchanotas  
pique-bons



**Spieße aus flexiblem Kunststoff, mit stumpfen Enden zur Unfallverhütung**

spikes made of flexible plastic, with blunt ends to prevent accidents  
pinchos de plástico flexible  
piques en plastique flexible

	cm	↑ cm	€
88855	9 x 5,5	10,5	3,80



**Bonleiste**

bill rail  
portafichas  
barre porte-bons



**matt poliert, mit Kugel-Greifsystem, zur Wandmontage geeignet, auch mit Magneten nutzbar**  
matt polished, small balls hold the bills, suited for wall fastening, can also be used with magnets

pulido mate, con sistema de bolas para colgar las notas para fijar en la pared, puede usarse con imán

poli mat, avec billes pour fixer sans effort tous types de fiches et papiers, peut se fixer sur plaque aimantée

	cm	↑ cm	€
88900	40 x 8	2	17,00
88901	50 x 8	2	18,40
88902	60 x 8	2	20,00



**Magnet-Messerhalter**

magnetic knife rack  
barra magnética para cuchillos  
barre aimantée pour couteaux



**mit 2 Magnetschienen und Haken, aus massivem Kunststoff, zur Wandmontage geeignet, Lieferung ohne Deko**

with 2 magnet racks and hooks, strong plastic, suited for wall fastening  
con 2 rails magnéticos y ganchos, plástico macizo, fijación en pared  
avec 2 rails aimantés et crochets, plastique robuste, fixation murale

	→ cm	€
88911	45	11,20
88912	60	13,60



**Folien-Abreißvorrichtung**

clingfilm tear-off-dispenser  
dispensador de film  
dérouleur de film



**mit Abreißkante / Säge-Messer, für Endlosfolie, als Tischgerät oder Wandgerät verwendbar**  
with saw, for endless rolls, can be fixed on the wall

con sierra para rollo de film continuo, se puede fijar en la pared  
avec lame dentée pour rouleau de film, peut être fixé au mur

	cm	↑ cm	€
88288	34 x 16	9	für Folienbreite 30 cm / for film width 30 cm para film ancho 30 cm / pour film largeur 30 cm 41,00
88287	49 x 16	9	für Folienbreite 45 cm / for film width 45 cm para film ancho 45 cm / pour film largeur 45 cm 46,00



**Schneidbrettständer**  
cutting board rack  
soporte para tablas  
rack pour planches à découper



für 6 Schneidbretter bis 25 mm Stärke, Lieferung ohne Deko

for 6 chopping boards up to 25 mm thickness

para 6 tablas de corte de 25 mm

pour 6 planches de 25 mm

	cm	↑ cm	€
88903	27 x 31	28	33,60



**Eiswaffel-Ständer**  
cornet stand  
soporte cucuruchos  
support à cornets



matt poliert, mit 4 Löchern, 2 x Ø 31 mm + 2 x Ø 26 mm

matt polished, with 4 holes, 2 x Ø 31 mm + 2 x Ø 26 mm

pulido mate, con 4 agujeros 2 x Ø 31 mm + 2 x Ø 26 mm

poli mat, 4 trous - 2 x Ø 31 mm + 2 x Ø 26 mm

	cm	↑ cm	€
11881	27,5 x 9,5	9	20,90



**Eisportionierer**  
ice cream scoop  
cuchara para helado  
cuillère à glace



hochglanzpoliert, mit Edelstahlfeder (physikalisch bedingt nicht korrosionsbeständig)

mirror polished, spring steel, spring is not stainless

pulido brillante, muelle de acero especial, no resistente al óxido

poli brillant, ressort acier spécial, non résistant à l'oxydation

	Ø cm	→ cm	ltr.	€
71006	6,5	23,5	1/12	11,60
71005	6,0	22,5	1/16	11,60
71004	5,5	22,0	1/20	11,60
71003	5,0	22,0	1/24	11,60
71002	5,0	21,5	1/30	11,60
71001	4,5	21,0	1/36	11,60

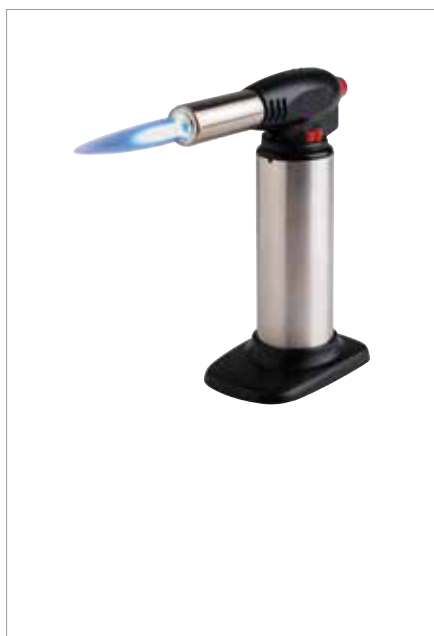

**Flambierbrenner**  
chefs blow torch  
soplete de cocina para flambear  
chalumeau de cuisine



mit handelsüblichem Feuerzeuggas auffüllbar, Flamme einstellbar bis ca. 1300° C, Brenndauer von mindestens 60 Minuten

to be filled with commercial lighter gas, flame adjustable up to approx. 1300° C, burning time of at least 60 minutes

rellenable con gas de mechero comercial, llama ajustable hasta 1300° C, tiempo de combustión de al menos 60 minutos

rempli avec gaz pour briquet commercial, flamme réglable jusqu'à 1300° C, temps de combustion d'au moins 60 minutes

	Ø cm	↑ cm	€
77315	4,5	16,5	33,00



Anwendungsbeispiel  
application example







# Covers & Accessories

GN COVERS .....	562
GN ROLLTOP COVERS .....	565
ROLLTOP COVERS .....	566
PLATE COVERS .....	567
SUPER DOME .....	568
COVERS .....	570
LIDS .....	572
COOLERS .....	575



**GN Kuppelhaube**

GN cover  
GN cúpula  
GN cloche bombée

glasklarer Kunststoff, Griff aus Zinkdruckguss

crystal clear plastic, die-cast zinc knob

plástico transparente, asa de zinc fundido a presión

plastique transparente, poignée en zinc moulé sous pression



	cm	↑ cm	GN		€
11021	33 x 28	17	1/2	geschlossen / totally closed cerrada / totement fermée	29,00
11022	33 x 28	17	1/2	mit Front-Ausschnitt / one long side cut out gran apertura frontal grande ouverture frontale	32,00
11026	54 x 33	20	1/1	geschlossen / totally closed cerrada / totement fermée	52,00
11027	54 x 33	20	1/1	mit Front-Ausschnitt / one long side cut out gran apertura frontal grande ouverture frontale	54,00
11028	54 x 33	20	1/1	mit seitlichem Ausschnitt one small side cut out pequeña apertura lateral petite ouverture latérale	54,00



**GN Kuppelhaube**

GN cover  
GN cúpula  
GN cloche bombée



**glasklarer Kunststoff, Griff aus Zinkdruckguss**

crystal clear plastic, die-cast zinc knob

plástico transparente, asa de zinc fundido a presión

plastique transparente, poignée en zinc moulé sous pression

	cm	↑ cm	GN		€
11070	54 x 33	20	1/1	geschlossen / totally closed cerrada / totalmente fermée	52,00
11071	54 x 33	20	1/1	mit Front-Ausschnitt / one long side cut out gran apertura frontal	54,00
11072	54 x 33	20	1/1	grande ouverture frontale mit seitlichem Ausschnitt one small side cut out	54,00
11073	33 x 28	17	1/2	geschlossen / totally closed cerrada / totalmente fermée	29,00
11074	33 x 28	17	1/2	mit Front-Ausschnitt / one long side cut out gran apertura frontal	32,00
				grande ouverture frontale	

**GN 1/1 Haube**

GN 1/1 cover  
GN 1/1 campana  
GN 1/1 cloche



**klappbar, passend für GN 1/1-Behälter, GN 1/1-Tablets, etc., nahezu bruchfest**

suitable for GN 1/1 chafing dish, GN 1/1 trays, GN 1/1 pans

plegable, para cubetas GN 1/1, bandejas GN 1/1 etc., muy resistente a la rotura

pliable, pour bacs GN 1/1, plateaux GN 1/1 etc., très résistant à la casse

	cm	↑ cm	GN		€
11013	53,0 x 32,5	6	1/1		29,00



**klappbar**  
adjustable

# QUALITÄTSHAUBEN

11042  
GN 1/1

11041  
GN 1/2



## GN Abdeckhaube

GN cover  
GN cubierta  
GN cloche



passend für GN Tablett, glasklarer Kunststoff, nahezu bruchfest

suitable for GN trays, clear plastic, nearly unbreakable

apto para bandejas GN, plástico transparente, muy resistente a la rotura

pour bacs et plateaux GN, plastique transparent, très résistant à la casse

	cm	↑ cm	* mm	GN	€
11043	32,5 x 17,6	10,5	3	1/3	17,00
11044	53,0 x 16,2	10,5	3	2/4	23,00

	cm	↑ cm	* mm	GN	€
11041	32,5 x 26,5	9,5	3	1/2	23,00
11042	53,0 x 32,5	9,5	3	1/1	32,00



stapelbar  
stackable



## GN 1/1 Haube „HOCHSTAPLER“

GN 1/1 cover  
GN 1/1 campana  
GN 1/1 cloche



glasklarer Kunststoff, Tablett fixiert sich auf der Haube - kein Rutschen möglich, nahezu bruchfest

clear plastic, tray fixes itself on the cover and can not slip off, nearly unbreakable

plástico transparente, la bandeja se fija a la tapa para que no se deslice, muy resistente a la rotura

en plastique transparent, le plat se fixe sur le dessous de la cloche pour ne pas glisser, très résistant à la casse

	cm	↑ cm	GN	fits to	€
11305	53 x 32,5	9	1/1	11295, 11300	30,00



**GN 1/1 Rolltophaube**

GN 1/1 rolltop cover  
GN 1/1 campana rolltop  
GN 1/1 cloche rolltop



patentiert, passend für GN-Behälter, -Tablets, etc., leichtgängig auf- und zuklappbar 90°  
patented, suitable for GN trays, solid quality, 90° opening  
patentada, para cubetas GN, bandejas GN, etc. fácil de abrir y cerrar 90°  
brevetée, pour bacs GN, plateaux GN, etc. s'ouvre et se ferme facilement à 90°

	cm	↑ cm	GN	€
11075	53,0 x 32,5	19	1/1	62,00



**GN Rolltophaube**

GN rolltop cover  
GN campana rolltop  
GN cloche rolltop



patentiert, passend für GN-Behälter, -Tablets, etc., leichtgängig auf- und zuklappbar 90°  
patented, suitable for GN trays, solid quality, 90° opening  
patentada, para bandejas GN, apertura 90°  
brevetée, pour plateaux GN, ouverture 90°

	cm	↑ cm	GN		€
11008	53,0 x 32,5	19	1/1	vergoldeter Griff / gold plated handle pomo dorado / bouton doré	62,00
11010	53,0 x 32,5	19	1/1	verchromter Griff / chrome plated handle pomo cromado / bouton chromé	62,00
12008	32,5 x 26,5	15	1/2	vergoldeter Griff / gold plated handle pomo dorado / bouton doré	59,00
12010	32,5 x 26,5	15	1/2	verchromter Griff / chrome plated handle pomo cromado / bouton chromé	59,00



**GN 1/1 Rolltophaube „SUNDAY“**

GN 1/1 rolltop cover  
GN 1/1 campana rolltop  
GN 1/1 cloche rolltop



Griff ABS verchromt, leichtgängig auf- und zuklappbar  
handle chrome plated, easy to open and close  
asa material ABS cromado, fácil de abrir y cerrar  
poignée matériel ABS chrome, ouverture et fermeture faciles

	cm	↑ cm	GN	€
11016	53,0 x 32,5	19	1/1	64,00



**GN 1/1 Rolltophaube**

GN 1/1 rolltop cover  
GN 1/1 campana abatible  
GN 1/1 cloche basculante



verchromter Zinkdruckguss-Griff / chrome plated metal handle / mango cromado de fundición a presión de zinc / poignée en zinc moulé sous pression chromé

	cm	↑ cm	GN	€
11018	53,0 x 32,5	19	1/1	64,00



**Rolltophaube „FOCUS“**

rolltop cover  
campana abatible  
cloche basculante



verchromter Griff / chrome plated handle / pomo cromado / bouton chromé

	cm	↑ cm	€
09013	44 x 33,5	17	28,00

## ROLLTOP COVERS

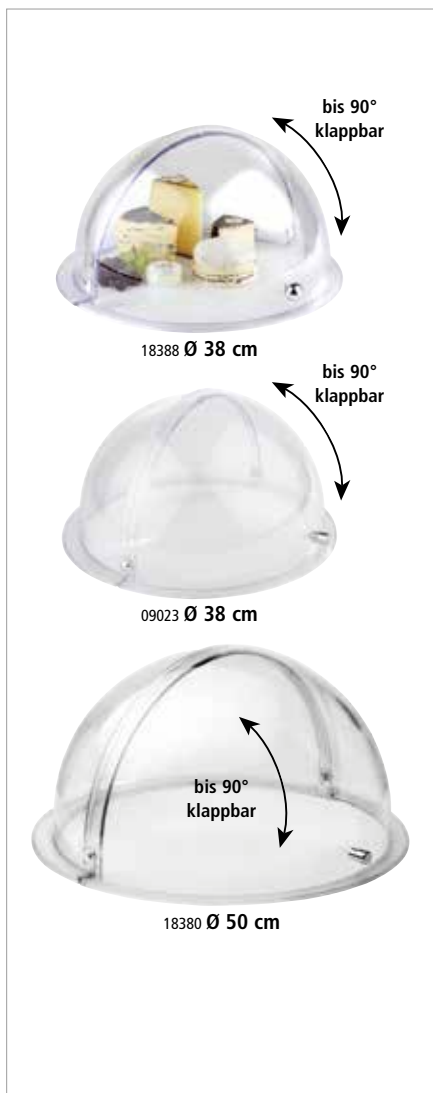

### Rolltophaube

rolltop cover  
campana abatible  
cloche basculante

glasklarer Kunststoff, leichtgängig auf- und zuklappen 90°

solid quality, to be opened 90°

plástico transparente, apertura 90°

plastique transparent résistant, ouverture 90°



	Ø cm	↑ cm		€
18388	38	20	mit verchromtem Kugelgriff / with chrome plated handle con pomo cromado / avec bouton chromé	24,00
18387	38	20	mit vergoldetem Kugelgriff / gold plated handle pomo dorado / bouton doré	24,00
09023	38	20	mit verchromtem Zylindergriff / chrome plated handle pomo cromado / bouton chromé	24,00
18380	50	26	mit verchromtem Zylindergriff / chrome plated handle pomo cromado / bouton chromé	62,00



### Frischhaltehaube

cover  
campana  
cloche bombée

glasklar, Griff aus 18/10 Edelstahl, schwere, stabile Ausführung

transparent, handle made of 18/10 stainless steel, heavy stable quality

transparente, mango de acero inoxidable 18/10, alta estabilidad

transparente, manche en acier inoxydable 18/10, anse chromée, très stable



	Ø cm	↑ cm		€
15350	16,5	10		11,00
15351	20,5	10		12,00



**Frischhaltehaube**

cover  
campana  
cloche



	Ø cm	↑ cm	fits to	€
11055	23	12	00825, 00827, 00848, 30148, 30334	6,00



Set 00827

glasklar, schwere stabile Ausführung  
clear, heavy stable quality



**Frischhaltehaube**

cover  
campana  
cloche



	cm	↑ cm	fits to	€
11056	25 x 12	10	00826, 00828, 00849, 30149, 30338, 85099	6,00



Set 00828

glasklar, schwere stabile Ausführung  
clear, heavy stable quality



06401

06701

**Frischhaltehaube**

cover  
campana  
cloche



	cm	↑ cm	€
06401	29,5 x 13,5	10	3,70
06701	21,6 x 16,2	7	2,80



18621

18121

Lieferung ohne Tablett | delivery without tray

**Frischhaltehaube**

cover  
campana  
cloche



	cm	↑ cm	€
18621	Ø 18	8,5	2,20
18121	35,5 x 27,8	7,5	6,20

# SUPER DOME

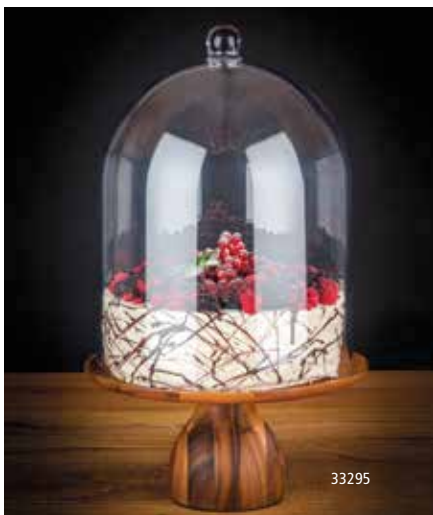





**Frischhaltehaube „SUPER DOME“**

cover  
campana  
cloche



schwere, glasklare Qualität  
stable, crystal clear quality  
muy resistente y transparencia cristalina  
haute résistance et transparence

	Ø cm	↑ cm	€
06525	30	40	74,00

passende Servier- Tortenplatten / suitable cake stands / porta pasteles compatibles /  
présentoirs à gâteaux compatibles

	Ø cm	↑ cm	fits to	Farbe / Colour	€
00468	31,0	3,5	06525		18,40
33294	33,0	8,0	06525		70,00
33295	33,0	16,0	06525		96,00



Servierbeispiel  
presentation example



Präsentationsmöglichkeiten  
presentation examples



**Frischhaltehaube**

cover  
campana  
cloche



schwere, glasklare Qualität  
stable, crystal clear quality  
calidad estable y transparencia cristalina  
qualité stable et clarté cristalline

	Ø cm	↑ cm	fits to	€
06519	21	17	33292, 33293	30,00
06520	30	22	00046, 00463, 00468, 00469, 00975, 00998, 15621, 15622, 33294, 33295, 83884, 83890, 83891, 84177, 84943, 84944	37,00
06521	36	27	00816, 33296, 33297	74,00



stapelbar  
stackable



Präsentationsmöglichkeiten  
presentation examples



# COVERS



06512

## Frischhaltehaube

cover  
campana  
cloche

glasklar, schwere stabile Ausführung, stapelbar

clear, heavy stable quality, stackable  
transparente, alta estabilidad, apilable  
transparente, très stable, empilable



	Ø cm	↑ cm		€
06512	30	11,5	mit verchromtem Griff / with chrom plated handle con botón cromado / avec bouton chromé	8,20
06517	30	12,5	mit verchromtem Griff / with chrom plated handle con botón cromado / avec bouton chromé	9,60



06515

## Frischhaltehaube

cover  
campana  
cloche

glasklar, schwere stabile Ausführung, stapelbar

clear, heavy stable quality, stackable  
transparente, alta estabilidad, apilable  
transparente, très stable, empilable



	Ø cm	↑ cm		€
06510	30	11,5		5,90
06515	33	12,5		7,50



stapelbar  
stackable



06501

## Frischhaltehaube

cover  
campana  
cloche



	Ø cm	↑ cm		€
06501	30	11		4,20
06504	30	9,5		6,40
06506	30	7		4,10



## Frischhaltehauben, 2er Set

covers, 2 pcs. set  
campanas, set de 2  
cloches, pack de 2



	Ø cm	↑ cm		€
40752	30	11		7,80



11051 Ø 22 cm



11052 Ø 24 cm



11053 Ø 28 cm



11054 Ø 28,5 cm

**Tellerabdeckhaube**  
plate cover  
cubierta para plato  
couverture pour assiette

passend für unterschiedliche Tellergrößen

suitable for different plate sizes

aptas para diferentes tamaños de platos

aptes pour différentes tailles d'assiettes



	Ø cm	↑ cm	passend für Tellergrößen / suitable for plate sizes	€
11051	22,0	7,0	Ø 21,5 cm	4,50
11052	24,0	7,5	Ø 22,5 - 23,0 cm	4,80
11053	28,0	6,5	Ø 26,0 - 26,5 cm	6,80
11054	28,5	6,5	Ø 27,0 - 27,5 cm	7,50



33209 BLACK



33220 CHROME

Servierbeispiele  
presentation example

passende Hauben  
suitable covers 11051, 11052



Deckel „FRIDA“

cover  
tapa  
couvercle



	Ø cm	↑ cm	fits to	€
84962	9	2,5	84930, 84931	3,10
84963	13	2,5	84605, 84606	3,40
84964	16	2,5	84607, 84608	3,80

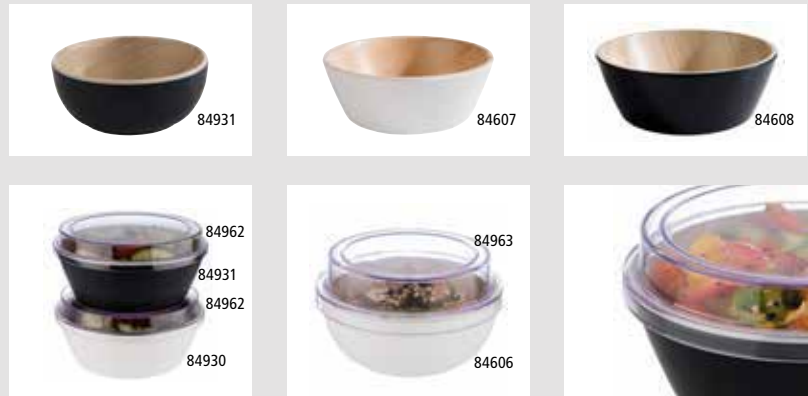

stapelbar / stackable



Deckel „FRIDA“

cover  
tapa  
couvercle



	cm	↑ cm	fits to	€
84965	13 x 13,0	2,5	84936, 84937	3,10
84966	17 x 17,0	2,5	84558, 84559	3,40
84967	18 x 16,5	2,5	84583, 84584	3,80
84968	18 x 11,0	2,5	84555, 84556	4,00

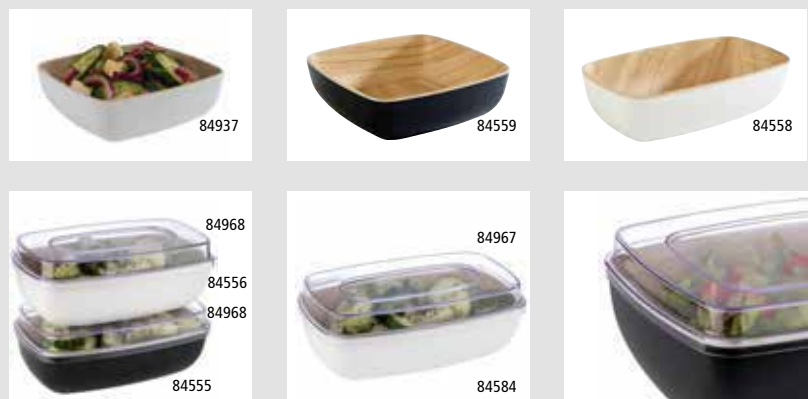

stapelbar / stackable



83921

## Deckel „FLOAT“ mit Löffelaussparung

cover, with notched for spoons  
tapa, con espacio para la cuchara  
couverture, avec encoche pour la louche



	cm	↑ cm	fits to		€
83921	19 x 19	1,3	83916, 83917	eckig	8,40
83922	25 x 25	1,3	83918, 83919	eckig	10,60



83600

83601

## Deckel „PURE“ mit Löffelaussparung

cover with notched for spoons  
tapa con espacio para la cuchara  
couverture avec encoche pour la louche



	cm	↑ cm	fits to		€
83600	19 x 19	1,5	79004, 79005, 83409, 83468, 84244, 85260, 85266		8,20
83601	25 x 25	1,5	83469, 83408, 84245, 84561, 84562, 85261, 85267		10,40



83605 Ø 8 cm

passend zu Schalen Ø 7,5 cm  
fits to bowls Ø 7,5 cm

83606 Ø 14,5 cm

passend zu Schalen Ø 14 cm  
fits to bowls Ø 14 cm

83607 Ø 20,5 cm

passend zu Schalen Ø 20 cm  
fits to bowls Ø 20 cm

## Deckel „CASUAL“, 5er Set

cover, 5 pcs. set  
tapa, set de 5  
couverture, set de 5



## Hygienischer Schutz für Ihre Speisen

- dichtschießend
  - schwappsicherer Transport
- protection for your food
- tightly closing
  - slosh-proof transport

- protección de alimentos
- con cierre hermético
  - transporte sin salpicaduras
- protection des aliments
- fermeture hermétique
  - transport sans éclaboussures

	Ø cm	↑ cm	fits to	pcs.	€ / set
83605	8,0	0,5	11866, 15400, 15416, 15461, 15462, 15467, 40655, 40656, 83881	5	3,60
83606	14,5	0,5	11865, 83700, 83701, 85104, 85105, 85107	5	6,00
83607	20,5	0,5	15404, 15420, 83704, 83705	5	7,00



83606

11865



83607

83704



stapelbar  
stackable



**Schutzdeckel mit Löffelaussparung**

cover  
tapa  
couvercle



**glasklar, klappbar, mit 10 Beschriftungsschildern**

transparent, with 10 cards for inscription  
plástico transparente, con 10 etiquetas para inscripción  
plastique transparent, avec 10 étiquettes pour inscription

	Ø cm		€
11868	14,5	mit verchromtem Griff / chrome plated handle botón cromado / bouton chromé	12,00
11878	23,5	mit verchromtem Griff / chrome plated handle botón cromado / bouton chromé	12,60

**Schilder, 10er Set / signs, 10 pcs. set / set de 10 cartelitos / set de 10 étiquettes**

	fits to	€
12879	11868	4,90
11879	11878	5,20



**Deckel klappbar mit Löffelaussparung**

cover hinged  
tapa con bisagra  
couvercle avec charnière



**glasklar, mit Designer-Griff, verchromt, ohne Beschriftungsschild**

clear, with designer handle, chrome plated, without card for inscription  
transparente, con pomo de diseño cromado, sin tarjetas para inscripción  
transparent, avec bouton chromé de design, sans étiquette pour inscription

	Ø cm	fits to	€
10889	23,5	11817, 11818, 11845, 11847, 11849	12,00



**Schale**

bowl  
cuenco  
bol



	Ø cm	↑ cm	ltr.	VE / unit	€ / pc.
11859	6,0	2,5	0,05	36	1,80
11866	7,5	3,5	0,09	36	1,90
11865	14,0	6,5	0,50	6	3,00
11875	23,0	10,5	2,50	6	7,00



**Kühlakku**  
cooler  
acumulador de frío  
accumulateur de froid



gefüllt mit Kühlflüssigkeit, nicht giftig, einfach im Gefrierfach einfrieren, unbegrenzt wiederverwendbar

freeze it in freezer, non toxic, filled with freezer-liquid, boundless reusable  
se enfría en el congelador, no tóxico, se puede reutilizar sin límite  
liquide eutectique qui accumule froid une fois dans le congélateur, non toxique, réutilisable sans limites

	∅ cm	↑ cm	Farbe / Colour	€
10777	15	2,5	White	5,40
10781	10,5	2,5	White	3,10
10661	10,5	2,0	White	3,40



**Kühlakku**  
cooler  
acumulador de frío  
accumulateur de froid



	∅ cm	→ cm	Farbe / Colour	€
00615	7,5	11,5	Black	10,50



**Kühlakku**  
cooler  
acumulador de frío  
accumulateur de froid



gefüllt mit Kühlflüssigkeit, nicht giftig, einfach im Gefrierfach einfrieren, unbegrenzt wiederverwendbar

freeze it in freezer, non toxic, filled with freezer-liquid, boundless reusable  
se enfría en el congelador, no tóxico, se puede reutilizar sin límite  
liquide eutectique qui accumule froid une fois dans le congélateur, non toxique, réutilisable sans limites

	cm	↑ cm	Farbe / Colour	€
10782	41 x 21	2,5	White	16,00
10791	25 x 19	2,5	White	7,90
11101	16 x 7,5	2,0	Blue	6,60

4er Set / 4 pieces set / set de 4 / set de 4



**Aufsteller „ACHTUNG RUTSCHGEFAHR“**  
stand  
letrero  
panneau



	cm	↑ cm	Farbe / Colour	€
71421	30 x 63	63	Yellow	8,90

*Laser-Logo  
Individual*

# Laserlogo Individual

- perfekte Lasergravuren
- perfectly Laser engravings
- grabado perfecto por láser
- marçage laser parfait

≥ 10  
pcs.



lasered by APS



DE

- unverwechselbar
- einzigartig
- imagefördernd

## Ihre individuelle Lasergravur von APS

Wir bieten Ihnen die Möglichkeit, unsere Produkte mit Ihrem individuellen Logo per Laser zu gravieren - einzigartig, unverwechselbar und bereits ab 10 Stück je Artikel. Die perfekte Beschriftung durch modernste Lasertechnologie ist spülmaschinenfest und somit dauerhaft auf allen Edelstahl- und Naturschieferprodukten, sowie auf versilberten und verchromten Metall-Artikeln umsetzbar. Machen Sie aus Ihren Gastronom-Behältern Ihre ganz persönlichen Unikate und werten Sie Ihre Servierartikel mit Ihrem eigenen Logo auf.

- geringe Mindestbestellmenge von nur 10 Stück
- kurze Lieferzeiten
- Logos bis zu einer Fläche von max. 10 x 10 cm realisierbar

ES

- único
- personalizado
- promotor de imagen

## Grabado laser por APS

Podemos grabar su logo y así personalizar los productos APS a partir de mínimo 10 unidades por referencia. Gracias a la novedosa tecnología de grabado por láser, la inscripción es perfecta y resistente al lavavajillas. Se puede aplicar a los artículos en acero inoxidable, pizarra natural, metal cromado y plateado.

- cantidad mínima de solamente 10 unidades
- realización rápida
- tamaño de logos hasta máximo 10 x 10 cm

EN

- distinct
- unique
- image enhancing

## Your individualised laser engraving by APS

We offer you the option of having your personalised logo engraved on our products - inimitable, unique, and available for delivery from only 10 pieces per product. The perfect inscription by use of the newest technology is dishwasher-safe and thus can be permanently applied to products made of stainless steel and natural slate, as well as silver-coated and chromed metal articles. Turn your gastronomic container into your individual, one of a kind article and enhance your serving items with your own logo.

- minimum order quantity of only 10 pieces
- swift delivery
- feasible logos are those with a maximum size of 10 x 10 cm

FR

- unique
- original
- porteur d'image

## Marcage laser par APS

Nous pouvons graver votre logo et ainsi personnaliser les produits APS à partir de 10 pièces par référence. Grâce à une technologie d'avant-garde de marquage par laser, l'inscription est parfaitement reproduite et résistante au lave-vaisselle. Ce type de marquage peut s'appliquer sur l'acier inoxydable, sur l'ardoise naturelle, sur le métal chromé ou argenté.

- quantité minimum de seulement 10 unités
- fabrication rapide
- taille du logo jusque 10 x 10 cm



## APS - BSCI-Mitglied

APS engagiert sich für die Verbesserung von Arbeitsbedingungen.

Wir sind Partner der europäischen Organisation BSCI. Die "Business Social Compliance Initiative" (BSCI) ist eine Initiative von Unternehmen zur Verbesserung der Arbeitsbedingungen in der globalen Versorgungskette.



## APS is a member of BSCI

APS is committed to the improvement of working conditions.

We are a partner of the European organization BSCI. The "Business Social Compliance Initiative" is an initiative of enterprises to improve working conditions in the global supply chain.

## APS - Garantierte Qualität

APS-Produkte entsprechen den Richtlinien der Europäischen Kommission. Diese enthalten Bestimmungen für Materialien, welche mit Lebensmitteln in Berührung kommen. Wir arbeiten sehr eng mit Zertifizierungsinstitutionen und Prüflaboren zusammen und können somit die Lebensmittelsicherheit (LFGB Regulation) der APS-Artikel garantieren.

## APS - Guaranteed quality



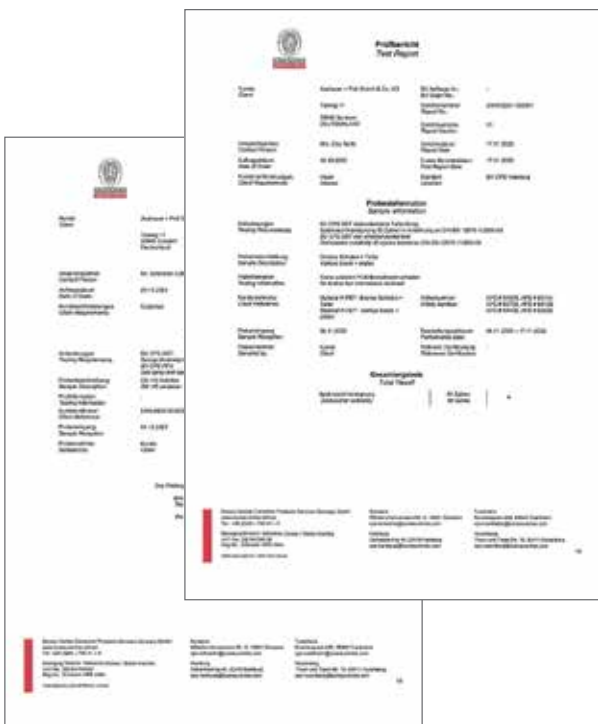

APS products comply with directives of the European Commission. This contains provisions for materials which come into contact with foodstuffs. We work very closely together with certification institutions and testing laboratories and are therefore able to guarantee the compatibility with foodstuffs (German LFGB regulation) of APS products.



## Icon-Index

 <b>neuer Artikel</b> new item	 <b>Made in Germany</b>	 <b>Made in the EU</b>	 <b>GN-Größen</b> GN norm
 <b>spülmaschinengeeignet</b> dishwasher-proof	 <b>nicht spülmaschinen-geeignet</b> not dishwasher-proof	 <b>feucht abwaschbar</b> wet washable	 <b>mikrowellengeeignet</b> microwave-proof
 <b>nicht mikrowellen-geeignet</b> not microwave-proof	 <b>nicht für Backofen</b> not for baking oven	 <b>keine direkte Hitze</b> not direct heat	 <b>max. 40°C</b>
 <b>kühlbar</b> for cooling	 <b>Antirutsch-Füßchen</b> non-slip feet	 <b>stapelbar</b> stackable	 <b>bruchsicher</b> shatter-proof
 <b>für Induktionsplatten</b> for induction use	 <b>360° drehbar</b> 360° rotatable	 <b>Eigenmontage</b> self assembly	 <b>nicht für Lebens- mittelkontakt</b> not food safe

## Material-Index

 <b>Aluminium</b> sehr leichtes Material; sehr gute elektrische und thermische Leitfähigkeit; korrosionsbeständig; Gebrauchstemperatur bis ca. +500 °C Pflege: niemals scheuernde Hilfsmittel verwenden; nur mit weichem Lappen und Spezialmitteln reinigen; keine Spülmaschinenreinigung!	<b>Aluminium</b> Very light material; very good electrical and thermal conductivity; corrosion-resistant; service temperature up to approx. +500 °C care: never use abrasive cleaners; clean only with a soft cloth and special cleaning agents; not suitable for dishwashers
 <b>Blaublech</b> Blaublech oder Blauglanzblech ist ein kaltgewalztes Feinblech mit fest haftender Eisenoxidschicht. Gebrauchstemperatur bis ca. 360 °C Pflege: nicht spülmaschinengeeignet	<b>Blue steel</b> Blue steel is a cold-rolled thin sheet with a firmly adhering layer of iron oxide. service temperature up to approx. 360 °C care: Not dishwasher-safe
 <b>Edelstahl 18/10</b> Werkstoff 1.4301; rostfrei; langlebig; gute isolierende Eigenschaften; absolut hygienisch und nicht toxisch; recyclebar; nicht resistent gegen dauerhaften Kontakt mit Chloriden und Säuren (z. B. Kochsalz und Fruchtsäuren); sterilisierbar; Oberfläche lässt sich vielfältig polieren; nicht magnetisch; Gebrauchstemperatur bis ca. 400 °C Pflege: pflegeleicht; maschinell oder per Hand mit milden Spülmitteln; möglichst keine Stahlwolle u. ä. verwenden; nach Erhitzung Schockabkühlung vermeiden	<b>Stainless steel 18/10</b> Material 1.4301; stainless; durable; good insulating properties; absolutely hygienic and non-toxic; recyclable; not resistant to permanent contact with chlorides and acids (e.g. table salt and fruit acids); sterilisable; surface can be polished in many ways; non-magnetic; service temperature up to approx. 400 °C care: easy to clean; machine or hand wash with mild detergents; if possible, do not use steel wool or similar; Avoid shock cooling after heating.
 <b>Edelstahl (unspezifisch)</b> niedrig nickelhaltige Edelstähle wie 14/4; nicht magnetisch; geringere allgemeine Resistenz als Edelstahl 18/10 Pflege: pflegeleicht; maschinell oder per Hand mit milden Spülmitteln; möglichst keine Stahlwolle u. ä. verwenden; nach Erhitzung Schockabkühlung vermeiden	<b>Stainless steel (unspecific)</b> Stainless steel with low nickel content such as 14/4; non-magnetic; lower general resistance than 18/10 stainless steel care: easy to clean; machine or hand wash with mild detergents; if possible, do not use steel wool or similar; Avoid shock cooling after heating.
 <b>Edelstahl 18/0</b> Werkstoff 1.4016; rostfrei; langlebig bei entsprechender Pflege; absolut hygienisch und nicht toxisch; gut härtbar, daher idealer Stahl für Tafelmesser, Tablett, Schneidewerkzeuge u. ä.; lässt sich hochglanzpolieren; für Nickelallergiker geeignet; magnetisch; nicht so chemikalienresistent wie Edelstahl 18/10; Gebrauchstemperatur bis ca. 400 °C Pflege: maschinell oder per Hand mit milden Spülmitteln; Ablagerungen von Kalk und Reinigerresten nach dem Spülen unbedingt entfernen; niemals mit Stahlwolle reinigen	<b>Stainless steel 18/0</b> Material 1.4016; stainless; long-lasting with appropriate care; absolutely hygienic and non-toxic; good hardening properties, therefore ideal steel for table knives, trays, cutting tools, etc.; can be polished to a high gloss; suitable for people allergic to nickel; magnetic; not as resistant to chemicals as stainless steel 18/10; service temperature up to approx. 400 °C care: by machine or by hand with mild detergents; Remove limescale and detergent residues after cleaning; never clean with steel wool



### Eisen

nicht rostfrei; charakteristische, strukturierte Oberfläche mit unterschiedlichen Schattierungen; durch wiederholten Schmiedevorgang ist das Material stark verdichtet und sehr hart; langlebig bei entsprechender Pflege

Pflege:

vor erstem Einsatz mit Öl und Kartoffelschalen „einbraten“; später nach jeder Reinigung einfetten; stets trocken lagern

### Iron

not rustproof; characteristic, structured surface with different shades; due to repeated forging process, the material is strongly compressed and very hard; long-lasting with appropriate care

care:

before first use, fry with oil and potato peelings; later grease after each cleaning; always store in a dry place



### Gusseisen

langlebig bei entsprechender Pflege; geeignet für alle Herdarten (inkl. Induktion); speichert lange Wärme und gibt sie gleichmäßig ab; absolut hygienisch bei unbeschädigter Oberfläche; relativ schweres Material; Überhitzung fast nicht möglich; nicht schlagfest; magnetisch

Pflege:

nach Gebrauch sofort mit heißem Wasser reinigen; bei Fleckenbildung mit Essig nachreinigen; niemals mit Stahlwolle reinigen; milde Spülmittel verwenden; stets trocken lagern



### Cast Iron

Long-lasting with appropriate care; suitable for all types of cookers (incl. induction); stores heat for a long time and releases it evenly; absolutely hygienic with undamaged surface; relatively heavy material; overheating is almost impossible; not impact-resistant; magnetic

care:

clean immediately with hot water after use; clean with vinegar if stains form; never clean with steel wool; use mild detergents; always store in a dry place



### Verchromter Stahl

nichtedles Metall mit hartem Chromüberzug; nicht säurefest; nach Beschädigung der Chromschicht kein Schutz gegen Umwelteinflüsse

Pflege:

niemals scheuernde Hilfsmittel verwenden; nur mit weichem Lappen

### Chrome plated steel

Metal with hard chrome coating; not acid-resistant; after damage to the chrome layer no protection against environmental influences

care:

never use abrasive cleaners; only with a soft cloth



### Versilberter Stahl

Edelmetallüberzug; nicht völlig säurefest; nicht über längere Zeit Sonnenlicht aussetzen

Pflege:

niemals scheuernde Hilfsmittel verwenden; nur mit weichem Lappen und Spezialmitteln reinigen; keine Spülmaschinenreinigung!

### Silver plated steel

Metal coating; not completely acid-resistant; do not expose to sunlight for long periods of time

care:

never use abrasive cleaners; clean only with a soft cloth and special cleaning agents; not suitable for dishwashers



### ABS – Acrylnitril-Butadien-Styrol

sehr gute Oberflächenhärte; temperaturwechselfest; Gebrauchstemperatur bis ca. +100 °C

Pflege:

spülmaschinengeeignet

### ABS - acrylonitrile butadiene styrene

very good surface hardness; resistant to temperature changes; service temperature up to approx. +100 °C

care:

dishwasher safe



### ACRYL – künstliches Harz

farblos; glasartig; durchsichtig; nicht splinternd; chemisch modifiziert als Plexiglas®; Gebrauchstemperatur ca. -40 °C bis ca. +50 °C

wichtiger Pflegehinweis:

nur handelsübliche Acrylspezialreiniger oder milde alkohol- und ammoniakfreie Reinigungsmittel verwenden; nicht spülmaschinengeeignet

### ACRYL - artificial resin

colourless; glass-like; transparent; not splintering; chemically modified as Plexiglas®; service temperature approx. -40 °C to approx. +50 °C

important care advice:

use only commercially available acrylic special cleaners or mild and ammonia-free cleaning agents; not suitable for dishwashers



### EVA - Ethylenvinylacetat

weich elastisch; glänzend; Gebrauchstemperatur bis ca. +60 °C

Pflege:

abwaschbar / wasserfest

### EVA - ethylene vinyl acetate

soft elastic; glossy; service temperature up to approx. +60 °C

care:

washable / waterproof



### GFK – Glasfaserverstärkter Kunststoff

starr; nahezu unzerbrechlich; Gebrauchstemperatur bis ca. +100 °C

Pflege:

spülmaschinengeeignet

### GFK - glass-fibre reinforced plastic

rigid; almost unbreakable; service temperature up to approx. +100 °C

care:

dishwasher-safe



### MF - Melamin

sehr hart; stoß- und kratzfest; hygienisch; Gebrauchstemp. ca. -30 °C bis +70 °C

Pflege:

säurebeständig; spülmaschinengeeignet

### MF - melamine

very hard; impact- and scratch-resistant; hygienic; service temp. approx. -30 °C to +70 °C

care:

acid-resistant; dishwasher safe



### MS - Kunststoff

farblos; glasartig; durchsichtig; Gebrauchstemperatur ca. 0 °C bis ca. +70 °C

Pflege:

nicht spülmaschinengeeignet

### MS - plastic

colourless; glass-like; transparent; service temperature approx. 0 °C to +70 °C

care:

not dishwasher-safe

**PA - Polyamid**

starr; bruch- und schlagfest; mattglänzend; Gebrauchstemperatur bis ca. +220 °C

Pflege:

spülmaschinengeeignet

**PA - polyamide**

rigid; break- and impact-resistant; matt glossy; service temperature up to approx. +220 °C

care:

dishwasher-safe

**PC - Polycarbonat**

starr; nahezu unzerbrechlich; sehr stabil; formbeständig in kochendem Wasser; mikrowellengeeignet; Gebrauchstemperatur ca. -30 °C bis ca. +100 °C

Pflege:

spülmaschinengeeignet

**PC - polycarbonate**

rigid; almost unbreakable; very stable; keeps its shape in boiling water; microwave safe; service temperature approx. -30 °C to approx. +100 °C

care:

dishwasher-safe

**PE - Polyethylen / HDPE – hochdichtes Polyethylen**

hart elastisch; unzerbrechlich; ausreichend formbeständig in heißem Wasser; glänzend; Gebrauchstemperatur ca. -30 °C bis ca. +120 °C

Pflege:

spülmaschinengeeignet

**NDPE – niederdichtes Polyethylen**

weich elastisch; unzerbrechlich; kurzzeitig formbeständig in heißem Wasser; nicht glänzend; Gebrauchstemperatur ca. -30 °C bis ca. +95 °C

Pflege:

spülmaschinengeeignet

**PE - polyethylene / HDPE - high-density polyethylene**

hard elastic; unbreakable; sufficiently dimensionally stable in hot water; shiny; service temperature approx. -30 °C to approx. +120 °C

care:

dishwasher safe

**NDPE - low density polyethylene**

soft elastic; unbreakable; briefly keeps its shape in hot water; not shiny; service temperature approx. -30 °C to approx. +95 °C

care:

dishwasher safe

**PET - Polyethylenterephthalat**

hart elastisch; ausreichend formbeständig in heißem Wasser; glänzend; Gebrauchstemperatur ca. -30 °C bis ca. +55 °C

Pflege:

spülmaschinengeeignet bis 55°C

**PET - Polyethylene terephthalate**

hard elastic; sufficiently dimensionally stable in hot water; shiny; service temperature approx. -30 °C to approx. +55 °C

care:

dishwasher safe up to 55°C

**PP - Polypropylen**

hart elastisch; unzerbrechlich; umweltschonend recycelbar; mikrowellengeeignet; Gebrauchstemperatur ca. -30 °C bis ca. +75 °C

Pflege:

spülmaschinengeeignet

**PP - polypropylene**

hard elastic; unbreakable; environmentally friendly recyclable; microwave safe; service temperature approx. -30 °C to approx. +75 °C

care:

dishwasher safe

**PS - Polystyrol**

starr; kratzfest; formbeständig in kochendem Wasser; Gebrauchstemperatur bis ca. +70 °C

Pflege:

spülmaschinengeeignet

**PS - polystyrene**

rigid; scratch-resistant; keeps its shape in boiling water; service temperature up to approx. +70 °C

care:

dishwasher safe

**PVC - Polyvinylchlorid**

säurebeständig; schwer entflammbar; Gebrauchstemperatur ca. -50 °C bis +60 °C

Pflege:

nicht spülmaschinengeeignet

**PVC - polyvinyl chloride**

acid-resistant; flame-retardant; service temperature approx. -50 °C to +60 °C

care:

not dishwasher safe

**SAN - Styrol-Acrylnitril**

gute Oberflächenhärte; temperaturwechselfest; Gebrauchstemperatur bis ca. +100 °C

Pflege:

spülmaschinengeeignet

**SAN - styrene acrylonitrile**

good surface hardness; resistant to temperature changes; service temperature up to approx. +100 °C

care:

dishwasher safe

**Silikon**

hohe thermische Beständigkeit; gute Kälteflexibilität; Gebrauchstemp. ca. -70 °C bis ca. +180 °C

Pflege:

spülmaschinengeeignet

**Silicone**

high thermal resistance; good low-temperature flexibility; service temperature approx. -70 °C to approx. +180 °C

care:

dishwasher safe

**Tetron**

Kunstfaser: 65 % Polyester, 35 % Viskose

Pflege:

maschinenwaschbar bis 30 °C

**Tetron**

Artificial fibre: 65 % polyester, 35 % viscose

care:

machine washable up to 30 °C

**Tritan®**

starr; unzerbrechlich; absolut formbeständig; sehr hohe Chemikalienbeständigkeit; Gebrauchstemperatur ca. -30 °C bis ca. +95 °C; nicht mikrowellengeeignet

Pflege:

spülmaschinengeeignet

**Tritan®**

rigid; unbreakable; keeps its shape in boiling water; very high chemical resistance; service temperature approx. -30 °C to approx. +95 °C; not microwaveable

care:

dishwasher safe



### Beton

Werkstoff Beton, coole Optik; handgefertigt

Pflege:

nicht spülmaschinengeeignet

### Concrete

Concrete material, cool look; handmade

care:

not dishwasher safe



### Porzellan

hitzebeständig bis ca. +220 °C

Pflege:

spülmaschinengeeignet

### Porcelain

heat-resistant up to approx. +220 °C

care:

dishwasher safe



### Schiefer

Naturschiefer versiegelt; lebensmittelecht;

Pflege:

nicht spülmaschinengeeignet

### Slate

Natural slate sealed; food-safe

care:

not dishwasher safe



### Holz

lebensmittelecht; nicht spülmaschinengeeignet; naturbedingte Abweichung in Form, Farbe, Maserung und Größe; Abweichungen stellen keinen Mangel dar

Pflege:

Vor dem ersten und nach jedem Gebrauch gründlich mit heißem Wasser und Spülmittel reinigen und nicht längere Zeit im Wasser liegen lassen. Anschließend gut abtrocknen und aufrecht trocknen lassen.

Ihr Holzprodukt pflegen Sie in regelmäßigem Abstand mit etwas geschmacksneutralem und handelsüblichem Speiseöl.

### Wood

food-safe; not dishwasher-safe; natural deviations in shape, color, grain in shape, color, grain and size; deviations do not constitute a defect constitute a defect

care:

Clean thoroughly with hot water and washing-up liquid before the first and after each use and do not leave in water for a long time. for a long time. Then dry well and leave to dry upright.

Care for your wooden product at regular intervals with a little tasteless and commercially available cooking oil.

## Function-Index



### RGB

Die RGB-Funktion ermöglicht anpassbare Lichtfarben durch Rot, Grün und Blau für eine personalisierte Beleuchtung.

### RGB

The RGB function allows customizable light colors through red, green, and blue, providing personalized illumination.



### CCT

Die CCT-Funktion ermöglicht die Anpassung der Farbtemperatur, was eine variable Lichtstimmung von warmweiß zu kaltweiß ermöglicht.

### CCT

The CCT function allows the colour temperature to be adjusted, enabling a variable lighting mood from warm white to cool white.



### 3-Stufen Dimmbar

Die 3-Stufen Dimmbarkeit bietet eine einfache Anpassung der Helligkeit in drei verschiedenen Stufen.

### 3-step dimmable

The 3-step dimming enables simple adjustment of the brightness in three different levels.



### Fernbedienung

Die Fernbedienung ermöglicht die gleichzeitige Steuerung mehrerer Leuchten und bequeme Anpassung von Einstellungen aus der Ferne.

### Remote control

The remote control enables simultaneous control of several lights and convenient adjustment of settings from a distance.



### IP54

Der IP54-Standard kennzeichnet die Staub- und Spritzwasserbeständigkeit, was den Einsatz der Leuchten im Freien ermöglicht.

### IP54

The IP54 standard indicates resistance to dust and splash water, allowing the lights to be used outdoors.

# Index

Artikel-Nr.	Prüfziffer	Seite															
0																	
00011	7	348	00393	4	150	00595	2	514	00746	8	537	00843	4	170, 280	00994	3	158, 289
00012	4	348	00394	1	150	00596	9	515	00747	5	537	00844	1	170, 280	00995	0	158, 289
00013	1	346	00395	8	150	00597	6	515	00750	5	162, 286	00845	8	282	00996	7	158, 289
00017	9	346	00396	5	150	00598	3	515	00751	2	162, 286	00846	5	282	00997	4	161
00018	6	351	00398	9	150	00599	0	557	00752	9	162, 286	00848	9	567	00998	1	160, 569
00019	3	352	00399	6	150	00600	3	520	00753	6	162, 286	00849	6	567	00999	8	160
00020	9	352	00401	6	320	00601	0	521	00754	3	163, 257, 270, 287	00864	9	171, 285	01000	0	149, 160
00021	6	348	00463	4	154, 569	00602	7	521	00755	0	163, 287	00867	0	166, 284	01001	7	157
00022	3	344	00468	9	153, 155, 211, 240, 568, 569	00603	4	520	00756	7	163, 287	00868	7	166, 284	01002	4	157
00023	0	348	00469	6	153, 211, 240, 569	00604	1	520	00757	4	163, 287	00869	4	166, 284	01003	1	157
00025	4	352	00500	6	151, 503	00605	8	521	00758	1	72	00870	0	167, 282	01004	8	157
00026	1	352	00502	0	151, 503	00606	5	521	00759	8	72	00871	7	167, 282	01010	9	170, 280
00027	8	354	00506	8	151, 503	00607	2	521	00760	4	73	00873	1	167, 282	01011	6	170, 280
00029	2	354	00508	2	151, 503	00610	2	547	00761	1	163, 283	00874	8	167, 282	01012	3	170, 280
00030	8	349	00510	5	151, 503	00611	9	547	00762	8	70	00875	5	167, 282	01013	0	171, 281
00031	5	355	00511	2	151, 503	00612	6	547	00763	5	70	00876	2	167, 282	01014	7	171, 281
00032	2	313	00515	0	151, 503	00615	7	128, 483, 575	00765	9	329, 490	00877	9	167, 282	01015	4	171, 281
00033	9	330, 492	00530	3	152, 504	00617	1	128, 482, 483	00766	6	330, 491	00878	6	171, 283	01016	1	169, 282
00036	0	349	00531	0	152, 504	00618	8	128, 483	00768	0	329, 330, 490, 491	00880	9	169	01017	8	169, 282
00037	7	347	00532	7	152, 504	00619	5	128, 483	00771	0	539	00881	6	169	01018	5	557
00040	7	544	00533	4	152, 504	00620	1	128, 483	00772	7	310, 540	00882	3	169	01019	2	557
00042	1	544	00534	1	152, 504	00621	8	128, 483	00775	8	310	00883	0	69	01020	8	556
00046	9	154, 569	00535	8	152, 504	00623	2	293	00776	5	310	00884	7	69	01021	5	281
00047	6	154	00536	5	152, 504	00625	6	293	00777	2	310	00885	4	69	01022	2	281
00048	3	509	00537	2	152, 504	00626	3	293	00778	9	310	00886	1	69	01023	9	170, 281
00050	6	509	00538	9	152, 504	00627	0	293	00779	6	310, 540	00887	8	166, 284	01024	6	280
00052	0	508	00539	6	152, 504	00629	4	521	00780	2	540	00889	7	165, 285	01025	3	280
00054	4	507	00540	2	152, 504	00634	8	329, 492	00785	7	540	00898	4	165, 285	01026	0	287, 557
00056	8	507	00541	9	152, 504	00636	2	78	00786	4	540	00899	1	165, 285	01050	5	96, 290
00060	5	345	00542	6	152, 504	00637	9	78	00787	1	540	00905	9	167, 281	01051	2	97, 291
00063	6	313	00543	3	152, 504	00650	8	431	00788	1	540	00906	6	167, 281	01052	9	97, 291
00064	3	147	00547	1	151, 503	00651	5	431	00790	1	164, 285	00907	3	170, 281	01053	6	96, 290
00065	0	147	00548	8	151, 503	00652	2	147	00791	8	164, 285	00908	0	170, 281	01054	3	97, 291
00067	4	147	00549	5	151, 503	00662	1	519	00792	5	164, 285	00910	3	44	01055	0	97, 291
00069	8	71, 346	00552	5	152, 504	00664	5	519	00793	2	164, 285	00911	0	44, 69	01056	7	96, 290
00070	4	347	00553	2	152, 504	00666	9	519	00794	9	98	00912	7	44	01057	4	96, 290
00071	1	345	00554	9	152, 504	00668	3	519	00795	6	98	00914	1	44	01058	1	96, 290
00074	2	349	00555	6	152, 504	00670	6	519	00796	3	98	00937	0	160, 288	01309	4	141
00076	6	348	00558	7	507	00671	3	516	00805	2	74	00941	7	158, 289	01310	0	141
00077	6	348	00559	4	507	00672	0	516	00806	9	69, 74	00942	4	158, 289	01311	7	141
00078	0	345	00560	0	506	00673	7	516	00807	6	74	00943	1	158	01312	4	141
00081	0	140	00561	7	506	00677	5	273	00808	3	166, 288	00945	5	158, 289	01313	1	141
00082	7	140	00562	4	506	00685	0	527	00809	0	168	00947	9	159, 288	01314	8	141
00084	1	140	00563	1	506	00686	7	527	00810	6	165, 284	00953	0	68	01317	9	141
00090	2	508	00564	8	506	00687	4	527	00811	3	165, 284	00954	7	68	01318	6	141
00091	9	508	00564	8	506	00688	1	527	00812	0	165, 268, 284	00955	4	69	01322	3	141
00092	6	544	00568	6	507	00691	1	273	00813	7	165, 268, 284	00956	1	69	01323	0	141
00093	3	544	00570	9	507	00692	8	273	00814	4	165, 284	00957	8	69	01324	7	141
00094	0	544	00572	3	346	00693	5	273	00815	1	74	00958	5	62	01332	2	141
00098	8	544	00574	7	509	00694	2	547	00816	8	74, 569	00959	2	68	01335	3	141
00099	5	544	00576	1	509	00695	9	547	00817	5	168	00960	8	63, 161	01338	4	141
00106	0	545	00578	5	509	00696	6	547	00820	5	148	00966	0	156	01348	3	141
00110	7	544	00580	8	510	00697	3	547	00821	2	148	00968	4	160	01699	6	149, 317
00113	8	544	00581	5	315, 505	00699	7	273	00822	9	148	00969	1	160	01712	2	141
00311	8	355	00582	2	506	00700	0	349	00825	0	148, 567	00971	4	159, 289, 304	02038	2	355
00381	1	140	00583	9	506	00711	6	516	00826	7	148, 567	00973	8	28, 30, 157, 386	02039	9	355
00382	8	140	00584	6	506	00712	3	516	00827	4	146, 567	00975	2	160, 569	02311	6	142
00383	5	140	00585	3	506	00713	0	516	00828	1	146, 567	00979	0	31, 156, 158	03038	1	342
00384	2	140	00586	0	509	00714	7	516	00830	4	45, 148	00984	4	161, 289	03039	8	342
00385	9	140	00587	7	515	00715	4	516	00831	1	518	00986	8	159, 288	03098	5	342
00388	0	140	00588	4	514	00716	1	516	00832	8	518	00987	5	159, 288	03099	2	342
00389	7	150	00589	1	514	00721	5	516	00833	5	518	00988	2	158, 289	03622	2	93, 241
00391	0	150	00590	7	514	00722	2	516	00834	2	518	00989	9	63, 161	03623	9	93, 241
00392	7	150	00591	4	514	00723	9	516	00835	9	163, 287	00990	5	30, 157	03824	0	140
			00592	1	515	00730	7	516	00840	3	556	00991	2	30, 157	04010	6	342
			00593	8	515	00740	6	537	00841	0	556	00992	9	30, 157	04011	3	342
			00594	5	515	00744	4	537	00842	7	556	00993	6	30, 157	04015	1	342
						00745	1	537							04446	3	316

06401	0	147, 567	10400	6	110, 111, 454, 455	10573	7	457	10803	5	119	11043	4	139, 188, 217, 379, 564	11597	2	104
06501	7	570				10574	4	457	10804	2	119				11598	9	104
06503	1	147	10403	7	110, 111, 454, 455	10575	1	457	10807	3	119	11044	1	67, 139, 188, 217, 379, 564	11599	6	104
06504	8	570	10404	4	111, 455	10576	8	457	10808	0	119	11051	9	60, 571	11616	0	30
06506	2	570	10405	1	111, 455	10577	5	457	10809	7	119	11052	6	60, 571	11617	7	30
06510	9	147, 241, 570	10409	9	112, 455	10578	2	457	10812	7	119	11053	3	571	11619	1	156
06512	3	45, 67, 74, 241, 570	10410	5	112, 455	10579	9	457	10814	1	119	11054	0	571	11620	7	28, 30, 386
06515	4	570	10411	2	112, 455	10585	0	457	10818	9	112	11055	7	144, 502, 567	11621	4	28, 29, 30, 386, 387
06517	8	570	10415	0	113	10586	7	457	10830	1	117, 120	11056	4	65, 144, 219, 502, 567	11622	1	29, 387
06519	2	45, 74, 154, 155, 208, 209, 211, 569	10416	7	113	10587	4	457	10833	2	117				11623	8	29, 387
			10417	4	113	10588	1	457	10836	3	22, 116	11065	6	139	11625	2	311
			10418	1	113	10589	8	457	10837	0	22, 116	11070	0	366, 369, 379, 563	11626	9	28, 30, 386
06520	8	45, 67, 74, 153, 154, 155, 208, 210, 211, 569	10422	8	115	10661	1	21, 38, 39, 575	10838	7	22, 116	11071	7	366, 369, 378, 379, 563	11627	6	29, 30, 387
			10424	2	114, 115	10663	5	117	10839	4	22, 116	11072	4	366, 369, 379, 563	11628	3	29, 387
			10426	6	114, 115	10668	0	103	10840	0	117	11073	1	72, 379, 563	11629	0	29, 387
06521	5	45, 74, 154, 155, 211, 569	10427	3	114	10690	1	73, 124, 283	10841	7	112, 455	11074	8	379, 563	11645	0	31, 156
			10428	0	114, 115	10691	8	124	10849	3	110, 454	11075	5	31, 32, 72, 156, 565	11649	8	311
06525	3	155, 211, 569	10430	3	115	10692	5	125	10850	9	117	11077	5	31, 32, 72, 156, 565	11650	4	311
06701	1	147, 567	10435	8	114	10693	2	125	10851	6	112, 115, 455				11651	1	311
08201	4	140	10440	2	116	10700	7	118, 120	10853	0	110, 112, 454, 455	11100	4	31, 139	11671	9	129, 413
09010	1	142	10450	1	110, 454	10701	4	119	10855	4	110, 112, 454	11101	1	34, 37, 575	11672	6	129, 413
09013	2	142, 565	10451	8	110, 454	10703	8	119	10867	7	119	11110	3	139	11675	7	399
09023	1	566	10500	3	458	10704	5	119	10870	7	22, 113	11119	6	25, 247	11683	2	399
09080	4	149	10501	0	114, 115, 458	10707	6	119	10871	4	22, 113	11150	9	138	11705	1	73, 124
09082	8	37	10502	7	458	10708	3	119	10872	1	22, 113	11155	4	138	11706	8	73, 124
09083	5	37	10503	4	458	10709	0	119	10873	8	22, 113	11244	5	405	11711	2	58
09090	3	35	10504	1	458	10710	6	119	10889	9	574	11295	7	138, 564	11712	9	58
09091	0	35	10505	8	113, 459	10711	3	119	10907	0	119	11300	8	138, 564	11713	6	58
09093	4	35	10506	5	273, 493	10712	0	119	10910	0	131	11305	3	138, 564	11714	3	58
09094	1	35	10509	6	459	10713	7	119	10911	7	131	11411	1	75	11719	8	28, 386
09099	6	149	10510	2	459	10714	4	119	10912	4	131	11413	5	75	11720	4	86
09100	9	34	10511	9	459	10715	1	119	10913	1	131	11414	2	75	11721	1	28, 386
09104	7	34	10512	6	458, 459	10716	8	119	10914	8	131	11444	9	75	11722	8	29, 387
09200	6	34	10513	3	458	10717	5	119	10915	5	129	11446	3	75	11723	5	28, 386
09204	4	34	10514	0	458	10718	2	112, 113, 455	10916	2	129	11455	5	75	11724	2	29, 387
			10515	7	458	10720	5	118	10917	9	129	11495	1	105, 108	11726	6	283, 311
1			10516	4	458	10721	2	123	10921	6	130	11496	8	105	11727	3	171, 283, 311
10318	4	490	10517	1	458	10722	9	123	10922	3	130	11497	5	105	11728	0	57, 107
10319	1	490	10520	1	124, 283	10738	0	18, 123, 444	10923	0	130	11498	2	105	11729	7	57, 107
10320	7	490	10525	6	144, 459	10739	7	18, 123, 444	10924	7	130	11499	9	105	11740	2	56
10321	4	329, 490	10526	3	458, 459	10741	0	123, 126	10990	2	132, 486	11503	3	31	11747	1	352
10322	1	489	10527	0	459	10742	7	123, 126	10991	9	132, 282, 486	11505	7	31	11748	8	352
10323	8	489	10528	7	459	10748	9	125	10992	6	132, 486	11522	4	109	11750	1	351
10325	2	489	10529	4	459	10749	6	125	10993	3	133, 487	11523	1	108, 109	11752	5	89, 350, 381, 430
10326	9	489	10530	0	459	10750	2	117	10994	0	133, 282, 487	11524	8	108	11753	2	89, 350, 381, 430
10327	6	489	10531	7	459	10757	1	117	10995	7	132, 486	11526	2	108	11754	9	89, 350, 381, 430
10328	3	488	10532	4	459	10764	9	122	10996	4	132, 486	11527	9	108	11755	6	351
10329	0	488	10533	1	459	10766	3	122	11000	7	139	11528	6	109	11762	4	87
10330	6	488	10534	8	459	10769	4	125	11008	3	27, 31, 33, 365, 565	11529	3	109	11763	1	87
10331	3	488	10535	5	459	10770	0	124	11010	6	31, 32, 33, 365, 565	11540	8	33	11765	5	87
10332	0	488	10536	2	459	10771	7	125				11541	5	33	11767	9	86
10334	4	488	10540	9	335, 456	10775	5	125	11013	7	563	11542	2	36	11768	6	86
10335	1	488	10541	6	335, 456	10776	2	125	11016	8	74, 565	11543	9	36	11770	9	87
10336	8	488	10542	3	335, 456	10777	9	21, 38, 39, 40, 119, 575	11018	2	26, 27, 365, 565	11544	0	32	11771	6	87
10350	4	488	10560	7	457				11020	5	139	11555	2	366	11775	4	133, 487
10351	1	488	10561	4	457	10778	6	103	11021	2	45, 562	11556	9	43	11776	1	133, 487
10352	8	131	10562	1	457	10781	6	575	11022	9	562	11557	6	62	11778	5	88
10353	5	130	10563	8	457	10782	3	31, 156, 575	11026	7	45, 366, 562	11558	3	62	11780	8	88
10354	2	130	10564	5	457	10788	5	118	11027	4	366, 369, 562	11563	7	133, 487	11781	5	88
10355	9	489	10565	2	457	10789	2	118	11028	1	366, 562	11572	9	43	11795	2	106
10360	3	489	10566	9	457	10791	5	31, 32, 33, 36, 575	11032	8	139	11573	6	43	11805	8	101
10361	0	489	10567	6	457				11040	3	139	11574	3	133, 487	11807	2	101
10362	7	489	10568	3	457	10792	2	122, 444	11041	0	139, 188, 217, 379, 562, 564	11575	0	133, 487	11810	2	39
10370	2	135, 279, 334, 496	10569	0	457	10795	3	118	11042	7	139, 188, 217, 369, 379, 562, 564	11576	7	133, 487	11811	9	38, 39
10371	9	135, 279, 334, 496	10570	6	457	10796	0	118				11595	8	104, 109	11812	6	38, 39
10372	6	135, 279, 334, 496	10571	3	457	10800	4	118				11596	5	104			
			10572	0	457	10801	1	119									
						10802	8	120									



11813	3	38	12010	5	565	13377	8	545	15332	5	385	16014	9	137, 333, 495	30072	9	543
11815	7	39	12065	5	139	13378	5	545	15334	9	385	16015	6	137, 333, 495	30075	0	433, 543
11816	4	38, 39	12100	3	139	13379	2	545	15335	6	385	16016	3	136, 137, 332, 333, 494, 495	30076	7	433, 543
11817	1	38, 574	12224	6	400	13380	8	143, 292	15336	3	385	16017	0	137, 333, 495	30077	4	433, 543
11818	8	38, 574	12225	3	400	13382	2	146	15337	0	385	17000	1	337, 437	30078	1	433, 543
11840	9	100	12232	1	42, 400	13385	3	146	15350	9	566	17001	8	337, 437	30108	5	316, 505
11841	6	100	12233	8	399	13622	9	146	15351	6	566	17002	5	337, 437	30110	8	316, 505
11845	4	40, 574	12235	2	400	13965	7	102	15400	1	227, 243, 573	17003	2	338, 339, 438, 439	30111	5	144, 501
11846	1	38, 39	12236	9	399	13966	4	59	15401	8	227	17004	9	338, 339, 438, 439	30112	2	144, 501
11847	8	39, 574	12243	7	405	13980	0	21	15402	5	227	17005	6	338, 339, 438, 439	30113	9	144, 501
11848	5	38, 39	12244	4	405	13981	7	21	15403	2	227	17006	3	338, 438	30114	6	145, 502
11849	2	39, 574	12245	1	398	13987	9	23, 102	15404	9	227, 243, 573	17007	0	338, 339, 438, 439	30115	3	144, 501
11859	1	106, 574	12249	9	398, 399	13990	9	20	15416	2	227, 243, 573	17020	9	340, 440	30116	0	144, 501
11865	2	105, 243, 573, 574	12265	9	51, 53, 406	13995	4	23	15417	9	227	17021	6	340, 341, 440, 441	30117	7	144, 501
11866	9	243, 573, 574	12266	6	50, 51, 53, 406	14000	4	15	15418	6	227	17022	3	340, 341, 440, 441	30118	4	145, 501
11868	3	38, 39, 105, 574	12272	7	85, 403	14001	1	15, 16	15419	3	227	17023	0	340, 440	30119	1	145, 501
11875	1	40, 104, 574	12275	8	85, 403	14002	8	15, 16	15420	9	227, 243, 573	17910	3	25	30130	6	143, 292, 500
11878	2	38, 39, 40, 104, 574	12276	5	85, 403	14003	5	15	15421	6	226, 227	17922	6	25	30131	3	143, 292, 500
11879	9	346, 574	12285	7	18, 403, 404	14004	2	15, 16	15424	7	226, 227	18121	2	567	30132	0	143, 264, 292, 500
11881	2	559	12287	1	129, 413	14005	9	15, 16	15425	4	227	18380	3	566	30133	7	143, 292, 500
11884	3	78	12291	8	394, 395, 404	14006	6	15	15449	0	227	18387	2	36, 365, 566	30134	4	143, 292
11885	0	78	12292	5	404	14007	3	15	15450	6	226, 227	18388	9	36, 37, 241, 365, 566	30140	5	144, 292, 500
11887	4	41	12294	9	404	14008	0	15	15451	3	227	18389	6	26, 365	30141	2	144, 292, 500
11888	1	41	12295	6	85, 390, 392, 393, 394, 395, 397, 403, 404	14009	7	15	15452	0	227	18621	7	567	30142	9	144, 292, 500
11889	8	41	12296	3	393, 404	14010	3	19, 66	15453	7	227	30000	2	99	30148	1	144, 502, 567
11891	1	41	12299	4	404	14011	0	19, 66	15454	4	227	30001	9	99	30149	8	144, 502, 567
11901	7	401	12300	7	398, 422	14012	7	19, 66	15455	1	227	30002	6	99	30200	6	382
11910	9	401	12310	6	405	14013	4	19, 66	15456	8	227	30003	3	99	30206	8	384
11915	4	401	12315	1	134, 412, 485	14014	1	19, 66	15457	5	227	30010	1	50	30207	5	384
11916	1	401	12316	8	134, 412, 485	14015	8	18, 111	15458	2	226, 227	30011	8	50	30208	2	384
11917	8	401	12322	9	396	14016	5	18, 111	15459	9	44	30013	2	50	30209	9	63, 373, 384
11921	5	353	12323	6	396	14019	6	18, 123	15460	5	227	30014	9	50	30210	5	382
11922	2	353	12324	3	397	14021	9	16	15461	2	227, 243, 573	30015	6	51	30220	4	382
11930	7	355	12325	0	397	14022	6	16	15462	9	226, 227, 243, 573	30016	3	51	30230	3	382
11931	4	355	12329	8	84, 402	14030	1	17	15467	4	227, 243, 573	30017	0	51	30240	2	382
11940	6	432	12330	4	84, 402	14031	8	17	15473	5	228	30018	7	51	30250	1	382
11945	1	427	12335	9	84, 402	14032	5	17	15474	2	228	30019	4	51	30260	0	547
11946	8	427	12336	6	84, 402	14033	2	17	15475	9	228	30021	7	99	30263	1	547
11947	5	427	12337	3	84, 402	14034	9	17	15477	3	228	30024	8	50	30270	9	382
11948	2	90, 428	12338	0	84, 402	14035	6	17	15485	8	228	30045	3	543	30276	1	383
11949	9	90, 428	12339	7	84, 85, 402, 403	14036	3	16	15504	6	228	30046	0	542	30277	8	383
11950	5	432	12350	2	398	14037	0	16	15505	3	226, 228	30047	7	542	30279	2	368
11951	2	90, 428	12352	6	391	14038	7	18	15506	0	44, 85, 226, 228, 403	30048	4	542	30280	8	368
11952	9	90, 428	12353	3	391	14039	4	18	15513	8	95, 228	30049	1	542	30281	5	368
11954	3	91, 429	12354	0	391	14040	0	18	15514	5	95, 226, 228	30050	7	21	30282	2	368
11955	0	23, 91, 429	12360	1	400	14050	9	18, 403	15620	3	67	30052	1	21	30283	9	368
11960	4	91, 429	12366	3	391, 394	14940	3	24	15621	0	67, 569	30057	6	542	30285	3	368
11965	9	90, 428	12366	3	391, 394	14941	0	24	15622	7	67, 569	30058	3	543	30286	0	368
11966	6	90, 362, 428	12370	0	391	14953	3	27	15623	4	67	30059	0	542	30299	0	361
11969	7	41	12371	7	391	14954	0	27	15921	1	312	30061	3	542	30310	2	383
11970	3	101	12372	4	391	14956	4	27	15925	9	312	30062	0	542	30329	4	29, 387
11971	0	103	12393	9	394, 397	14965	6	102	15926	6	312	30063	7	542	30331	7	29, 387
11972	7	103	12394	6	393	14966	3	59	16000	2	136, 332, 494	30065	1	433, 546	30332	4	445
11973	4	103	12396	0	395	14970	0	26	16001	9	136, 332, 494	30066	8	433, 546	30333	1	453
11974	1	103	12397	7	391, 395	14980	9	21	16002	6	136, 332, 494	30067	5	433, 546	30334	8	64, 567
11975	8	101	12398	4	395	14981	6	21	16003	3	137, 333, 495	30068	2	433, 546	30335	5	60
11977	2	341, 426, 441	12399	1	395	14987	8	23, 102	16004	0	137, 333, 495	30069	9	433, 546	30336	2	65, 219
11978	9	423	12403	5	394, 397	14990	8	20	16005	7	137, 333, 495	30070	5	433, 546	30337	9	65, 379
11979	6	426	12404	2	393	14995	3	23	16006	4	137, 333, 495	30071	2	433, 546	30338	6	65, 567
11980	2	106	12483	7	394	15215	1	229	16007	1	136, 137, 332, 333, 494, 495	30063	7	542	30339	3	64
11981	9	106	12484	4	394	15216	8	229	16008	8	137, 333, 495	30065	1	433, 546	30340	9	371
11986	4	106	12879	8	346, 574	15217	5	229	16009	5	136, 332, 494	30066	8	433, 546	30341	6	371
11998	7	91, 352, 429	12940	5	24	15320	2	228, 385	16010	1	136, 332, 494	30067	5	433, 546	30345	4	371
11999	4	91, 352, 429	12941	2	24	15322	6	228, 385	16011	8	136, 332, 494	30068	2	433, 546	30346	1	371
12000	6	139	12990	0	478	15324	0	228, 385	16012	5	137, 333, 495	30069	9	433, 546	30347	8	371
12008	2	565	13122	4	146	15326	4	385	16013	2	137, 333, 495	30070	5	433, 546	30348	5	371
						15331	8	385				30071	2	433, 546	30350	8	371

30351	5	371	33215	7	61	36037	2	476	40137	2	364	40293	5	26, 29, 362, 387	40510	3	331, 492
30355	3	370	33216	4	61	36038	9	451	40139	6	364	40294	2	26, 365	40511	0	299
30356	0	169, 282, 370	33217	1	61	36044	0	446	40140	2	364	40295	9	26, 365	40516	5	273, 464
30360	7	371	33220	1	61, 571	36045	7	446	40144	0	43, 364	40296	6	361	40517	2	273, 464
30361	4	371	33232	4	43	36046	4	446	40148	8	364	40297	3	361	40535	6	303
30370	6	371	33238	6	61	36048	8	448	40149	5	365	40299	7	361	40536	3	303
30371	3	371	33246	1	106, 278	36052	5	448	40150	1	365, 366	40310	9	296	40537	0	303
30380	5	372	33248	5	61	36053	2	448	40152	5	364	40311	6	296	40538	7	307
30385	0	372	33249	2	93	36054	9	448	40153	2	365	40312	3	296	40539	4	307
30390	4	372	33250	8	93	36055	6	443	40159	4	364	40313	0	296	40540	0	304
30395	9	372	33251	5	93	36056	3	449	40179	2	367	40320	8	296	40541	7	304
30396	6	372	33252	2	93	36057	0	448	40182	2	367	40330	7	300	40543	1	309
30410	9	378	33255	3	95, 99	36062	4	449	40185	3	264	40331	4	300	40544	8	309
30411	6	378	33256	0	95, 99	36063	1	449	40186	0	149, 261	40333	8	300	40545	5	309
30412	3	379	33260	7	93	36066	2	443	40187	7	149, 261	40410	6	295	40546	2	303
30413	0	379	33261	4	93	36068	6	445	40188	4	149, 261	40411	3	295	40547	9	303
30414	7	378	33262	1	93	36069	3	445	40189	1	383	40412	0	295	40548	6	303
30415	4	378	33269	0	93, 98	36074	7	450	40190	7	383	40414	4	301	40549	3	305
30416	1	378	33270	6	93, 98	36075	4	453	40191	4	364	40415	1	296	40550	9	305
30417	8	378	33271	3	93, 98	36077	8	446	40192	1	364	40416	8	308	40551	6	305
30418	5	378	33272	0	93	36087	7	448	40193	8	364	40417	5	308	40552	3	305
30420	8	377	33273	7	93	36090	7	452	40194	5	364	40418	2	308	40553	0	57, 107, 304
30421	5	377	33280	5	95	36095	2	127, 447	40195	2	364	40419	3	300	40554	7	57, 107, 304
30422	2	377	33281	2	95	36096	9	127, 447	40196	9	364	40424	3	300	40555	4	169, 283, 301, 303
30423	9	377	33282	9	94, 215, 293	36099	0	73, 452	40198	3	366	40435	9	294	40556	1	169, 282, 283, 301, 303
30424	6	377	33288	1	45	36100	3	127, 447	40200	3	314	40436	6	294	40557	8	307
30425	3	374	33292	8	154, 569	36101	0	127, 447	40201	0	314	40437	3	294	40558	5	307
30426	0	374	33293	5	154, 569	36102	7	478	40202	7	314	40438	0	294	40561	5	309
30427	7	374	33294	2	154, 155, 568, 569	36103	4	478	40203	4	314	40439	7	294	40562	2	309
30428	4	374	33295	9	154, 155, 568, 569	36104	1	452	40204	1	314	40440	3	296	40563	9	309
30429	1	374	33296	6	154, 569	36105	8	452	40205	8	314	40441	0	296	40570	7	302
30430	7	380	33297	3	154, 155, 569	36106	5	127, 444	40206	5	314	40442	7	294	40571	4	302
30431	4	380	33299	3	154, 155, 569	36107	2	127, 444	40207	2	315	40445	8	299	40572	1	302
30435	2	380	33300	0	54	36108	9	127, 444	40208	9	314	40446	5	299	40573	8	302
30436	9	380	33301	7	55	36109	6	127, 444	40212	6	369	40450	2	296	40574	5	302
30437	6	380	33302	4	54	36111	9	127, 444	40214	0	369	40453	3	301	40575	2	302
30438	3	380	33302	4	54	36112	6	127, 444	40216	4	369	40454	0	301	40576	9	302
30439	0	380	33303	1	55, 94	36115	7	443, 445	40220	1	363	40455	7	298	40577	6	302
30440	6	370	33304	8	54, 55, 94	36116	4	445	40222	5	363	40457	1	298	40578	3	308
30441	3	370	33305	5	73, 94	36120	1	444	40223	2	362	40458	8	298	40579	0	308
30442	0	370	33306	2	46, 92	36121	8	444	40224	9	363	40461	8	297, 298	40580	6	306
30443	7	370	33307	9	92	36122	5	452	40225	6	362	40462	5	297, 298	40581	3	306
30444	7	370	35065	6	406	36123	2	452	40226	3	363	40463	2	298	40582	0	306
30445	1	370	35343	5	406	36124	9	452	40227	0	362	40464	9	298	40583	7	306
30446	8	370	35711	2	316	36125	6	256, 450	40228	7	363	40470	0	297	40600	1	262
30450	5	370	35712	9	316	36126	3	450	40229	4	362	40472	4	297	40601	8	159, 166, 262
30451	2	370	35716	7	73, 124, 316	36127	0	256, 450	40230	0	363	40474	8	297	40602	5	262
30452	9	375	35720	4	315	36128	7	450	40240	9	363	40476	2	297	40603	2	159, 262
30453	6	375	35730	3	315	36129	4	451	40242	3	108, 363	40478	6	297	40604	9	265
30454	3	375	35734	1	315	36130	0	126, 447	40243	0	108, 362	40480	9	297	40605	6	263
30455	0	375	35912	3	316	36131	7	452	40244	7	363	40482	3	300	40606	3	263
30470	3	376	36003	7	443	36140	9	53, 71, 451	40245	4	362	40485	4	299	40607	0	263
30471	0	376	36004	4	443	36233	8	315	40246	1	363	40486	1	331, 491	40610	0	262
30472	7	376	36010	5	467	36323	6	315	40247	8	362	40487	8	331, 492	40611	7	262
30473	4	376	36011	2	467	38202	2	140	40249	2	362	40488	5	329, 490	40612	4	262
30500	7	52	36013	6	476	4			40260	7	363	40490	8	331, 491	40613	1	262
30501	4	52	36015	0	477	40007	8	353, 367	40262	1	363	40494	6	331, 491	40616	2	263
30502	1	52	36016	7	477	40009	2	353, 367	40263	8	363	40498	4	491	40617	9	263
30503	8	53	36017	4	477	40010	8	353, 367	40264	5	363	40499	1	491	40618	6	263
30504	5	53	36020	4	442	40011	5	353, 367	40270	6	363	40501	1	310	40620	9	262
33202	7	94	36021	1	442	40012	2	353, 367	40272	0	363	40503	5	310	40621	6	262
33206	5	59	36025	9	442	40013	9	353, 367	40274	4	363	40504	2	169, 282, 309	40622	3	262
33207	2	59	36026	6	442, 445	40110	5	142	40276	8	363	40505	9	309	40623	0	262
33208	9	60	36028	0	442, 445	40130	3	353, 367	40290	4	26, 109, 362	40506	6	331, 491	40624	7	262
33209	6	60, 571	36030	3	451	40131	0	353, 367	40291	1	26, 109, 362	40507	3	310	40625	4	159, 262, 288
33210	2	62	36032	7	449	40132	7	364	40292	8	26, 29, 362, 387	40508	0	330, 491	40626	1	262
33211	9	61	36033	4	476	40135	8	364				40509	7	330, 491			
33212	6	61	36034	1	449												
33214	0	61															

40627	8	262	40726	8	257, 270	50605	3	360	60525	1	324	71490	8	17, 28, 76, 127, 344, 346, 386, 447	75841	4	526
40628	5	262	40727	5	257, 270	50606	0	360	60526	8	325				75842	1	526
40629	2	262	40728	2	270	50607	7	60, 360	60527	5	324	71491	5	346	75843	8	526
40630	8	263	40729	9	163, 270, 287	50608	4	360	60528	2	323	71492	2	349	75844	5	526
40631	5	263	40730	5	260	50612	1	360	60530	5	322	71493	9	349	75850	6	523
40632	2	266	40731	2	260	50620	6	361	60531	2	322	71494	6	349	75851	3	523
40636	0	168, 266	40732	9	260	50621	3	361	60536	7	328	71495	3	345	75852	0	523
40637	7	266	40733	6	260	50622	0	361	60537	4	328	71496	0	344	75853	7	479, 523
40638	4	266	40734	3	260	50623	7	361	60540	4	322	71497	7	344	75854	4	479, 523
40640	7	263, 329, 489	40735	0	260	50624	4	361	60541	1	322	71510	3	347	75855	1	479, 523
40642	1	261	40736	7	260	50625	1	361	60542	8	321	71512	7	347	75860	5	522
40643	8	261	40737	4	260	50626	8	361	60543	5	328	71512	7	347	75861	2	522
40644	5	261	40738	1	260	50627	5	361	60544	2	327	71513	4	347	75862	9	522
40645	2	266	40740	4	261	50630	5	360	60545	9	327	71516	5	347	75863	6	522
40646	9	266	40741	1	261	50631	2	360	60546	6	327	71520	2	344	75864	3	522
40647	6	266	40742	8	261	50644	2	369	60551	0	325	71521	9	343	75865	0	522
40654	4	264	40752	7	570	50702	9	359	60552	7	326	71522	6	343	75866	7	522
40655	1	143, 243, 264, 292, 500, 573	40760	2	271	50707	4	359	60554	1	326	71523	3	343	75867	4	522
40656	8	143, 243, 264, 292, 500, 573	40761	9	271	50710	4	358	60580	0	318	71527	1	343	75867	1	522
40657	5	264	40762	6	271	50712	8	358	60581	7	318	71528	8	343	75869	8	522
40658	2	264	40763	3	271	50722	7	359	60582	4	318	71529	5	343	75900	8	517
40659	9	264	40764	0	271	50800	2	360	60583	1	319	71531	8	344	75902	2	517
40660	5	261	40765	7	271	50801	9	360	60584	8	319	73502	6	552	75903	9	517
40661	2	267	40766	4	271	50802	6	360	60585	5	319	73505	7	552	75904	6	517
40662	9	267	40767	1	271	50803	3	360	60586	2	319	73506	4	552	75906	0	517
40663	6	267	40768	8	271	50805	7	360	61190	0	142	73507	1	552, 553	75907	7	517
40664	3	267	40770	1	79	50806	4	360	61280	8	142	73508	8	552	75908	4	517
40665	0	267	40771	8	79	50807	1	44, 360	61400	0	142	73509	5	552	75912	1	517
40666	7	267	40772	5	79	50808	8	360	65060	2	317, 407	73510	1	552	77315	8	559
40667	4	267, 313	40773	2	79	50815	6	360	65061	9	407	73511	8	552	77338	7	541
40668	1	267, 313	40774	9	79	50817	0	360	65062	6	407	73513	2	552	79000	1	46
40669	8	267	40775	6	79	50823	1	360	66900	0	511	73515	6	553	79001	8	46
40670	4	143, 159, 169, 264, 292, 500	40776	3	79	50905	4	358	66901	7	511	73750	1	554	79002	5	46
40676	6	91, 269, 429	40780	0	258	50908	5	358	66902	4	511	74201	7	537	79003	2	46
40677	3	282	40781	7	258	50910	8	358	66904	8	551	74402	8	539	79004	9	46, 573
40680	3	269	40782	4	258	50913	9	358	66905	5	498	74404	2	539	79005	6	46, 573
40681	0	269	40783	1	259	50915	3	358	66906	2	498	74700	5	538	79006	3	49, 425
40685	8	164, 171, 264, 285	40784	8	259	50918	4	358	66907	9	121, 499	74701	2	538	79007	0	49, 425
40686	5	171, 264, 283	40785	5	259	6			66908	6	121, 499	74702	9	538	79008	7	46
40690	2	265, 373	40786	2	259	60002	7	324	66909	3	121, 499	74703	6	538	79009	4	46
40691	9	265, 373	40790	9	272	60012	6	325	66910	9	497	74705	0	538	79010	0	48
40692	6	265, 373	40791	6	272	60014	0	323	66911	6	497	74706	7	538	79011	7	48
40693	3	265, 373	40792	3	272	60015	7	325	66912	3	497	74707	4	538	79012	4	48
40694	0	265, 373	40793	0	272	60016	4	323	66913	0	497	74721	0	539	79013	1	48
40695	7	265, 373	40794	7	272	60018	8	323	66914	7	497	74722	7	539	79014	8	47
40700	8	257	40795	4	272	60019	8	323	66915	4	497	74731	9	541	79015	5	47
40701	5	257	40800	5	354	60018	8	323	66916	1	497	74750	0	492	79016	2	47
40702	2	257	40801	2	354	60037	9	320	66917	8	497	75600	7	528	79017	9	47
40703	9	257	40802	9	354	60038	6	320				75800	1	525	79018	6	47
40704	6	257	40900	2	254	60040	9	321	7			75801	8	524	79019	3	47
40705	3	257	40901	9	255	60041	6	324	71001	6	528, 559	75803	2	528	79020	9	47
40706	0	257	40902	6	254	60042	3	321, 327	71002	3	528, 559	75804	9	528	79021	6	47
40707	7	257	40903	3	255	60044	7	326, 328	71003	0	528, 559	75805	6	479	79022	3	46
40708	4	257	40904	0	254	60045	4	326	71004	7	528, 559	75806	3	525	79023	0	46
40709	1	257	40905	7	255	60046	1	326	71005	4	528, 559	75807	0	525	79024	7	47
40710	7	257, 263	40906	4	254	60270	0	142	71006	1	528, 559	75808	7	529	79025	4	47
40711	4	257, 263	40907	1	255	60310	3	142	71400	7	505	75809	4	529	79026	1	47
40712	1	256	5			60503	9	320	71421	2	550, 575	75810	0	524	79027	8	47
40713	8	256	50002	0	62	60508	4	321	71430	4	493	75820	9	479, 529	79028	5	47
40720	6	270	50205	5	359	60509	1	322	71431	1	484, 551	75821	6	479, 529	79029	2	47
40721	3	270	50210	9	359	60510	7	321	71433	5	505	75822	3	524	79030	8	49, 425
40722	0	257, 270	50305	2	359	60511	4	321	71441	0	369, 427	75823	0	524	79031	5	49, 425
40723	7	257, 270	50400	4	359	60512	1	322	71460	1	347	75824	7	524	79032	2	49, 425
40724	4	270	50600	8	360	60520	6	324	71461	8	347	75825	4	523	79033	9	49, 425
40725	1	270	50601	5	360	60521	3	323	71470	0	346	75830	8	523	79034	6	49, 425
			50602	2	360	60522	0	323	71471	7	346	75831	5	523	79035	3	49, 425
			50603	9	360	60523	7	324	71480	9	346	75832	2	523	79036	0	49, 425
						60524	4	325				75840	7	526	79037	7	49, 425

79038	4	48	81700	5	415	82068	5	420	82301	3	422	83466	8	233	83740	9	207
79039	1	48	81701	2	415	82069	2	420	82306	8	422	83467	5	233	83742	3	207
79040	7	48	81702	9	415	82070	8	420	82307	5	274, 275, 278	83468	2	233, 235, 573	83744	7	207
79041	4	48	81704	3	415	82072	2	420	82308	2	274, 275, 278	83469	9	233, 235, 573	83748	5	108, 251, 424
79553	2	62	81706	7	415	82073	9	420	82309	9	274, 275, 278	83479	8	232	83749	2	108, 251, 424
8			81707	4	415	82074	6	420	82310	5	106, 159, 171, 275, 276, 278, 283, 288, 311	83480	4	158, 232, 289	83750	8	251, 424
80023	6	418	81791	3	417	82076	0	420	82312	9	106, 159, 275, 276, 278, 288	83481	1	56, 232	83751	5	251, 424
80024	3	418	81795	1	417	82077	7	420	82314	3	106, 159, 171, 275, 276, 278, 283, 288, 311	83482	8	232	83752	2	251, 424
80025	0	418	81796	8	423	82078	4	420	82316	7	64, 159, 168, 275, 277, 278, 283, 288, 289	83486	6	249	83753	9	108, 109, 251, 424
80026	7	418	81800	2	415	82081	4	420	82318	1	278	83487	3	249	83754	6	251, 424
80027	4	418	81801	9	415	82100	2	422	82319	8	278	83488	0	508	83755	3	251, 424
80028	1	418	81802	6	415	82101	9	419	82328	0	77, 102	83489	7	508	83756	0	251, 424
80028	1	418	81804	0	415	82104	0	419	82338	9	278	83490	3	232	83757	7	108, 109, 251, 424
80029	8	418	81804	0	415	82106	4	419	82345	7	276, 278	83491	0	56, 232	83758	4	251, 424
81000	6	415	81806	4	415	82108	8	419	82346	4	275, 276, 278	83492	7	232	83759	1	109, 251, 424
81095	2	415	81850	7	416	82108	8	419	82347	1	275, 276, 278	83498	9	235	83777	5	243, 271
81100	3	415	81891	0	417	82110	1	419	82350	1	163, 171, 277, 285, 287	83499	6	235	83780	5	243, 271
81101	0	415	81895	8	417	82112	5	419	82352	5	276	83500	9	42, 233	83781	2	243, 265, 271
81102	7	415	81901	6	416	82113	2	419	82354	9	277	83514	6	233	83782	9	243, 271
81104	1	415	81902	3	416	82114	9	419	82355	6	25, 423	83572	6	235	83783	6	243, 271
81106	5	415	81903	0	416	82116	3	419	82356	3	25, 423	83573	3	235	83785	0	239
81108	9	415	81904	7	416	82117	0	419	82357	0	25, 423	83574	0	235	83787	4	239
81109	6	415	81905	4	416	82118	7	419	82359	4	171, 277, 285	83575	7	235	83788	1	92, 239
81116	4	405	81906	1	416	82119	4	419	82360	0	275	83592	4	232	83789	8	239
81117	1	418	81907	8	416	82120	0	419	82361	7	275	83597	9	232	83790	4	239
81118	8	418	81908	5	416	82122	4	419	82362	4	275	83600	6	219, 235, 573	83798	0	243, 271
81191	1	417	81909	2	416	82123	1	419	82363	1	275	83601	3	214, 219, 235, 573	83799	7	239
81195	9	417	81910	8	416	82128	6	419	82370	9	275, 277	83605	1	243, 573	83801	7	250, 431
81198	0	423	81911	5	416	82129	3	419	82371	6	275, 277	83606	8	243, 573	83803	1	250, 431
81199	7	423	81996	2	418	82130	9	419	82394	5	278	83607	5	243, 573	83828	4	238, 247
81200	0	415	81997	9	418	82132	3	419	82395	2	278	83610	5	508	83830	7	238, 247
81201	7	415	81998	6	418	82134	7	419	82419	5	432, 550	83611	2	508	83832	1	56
81202	4	415	81999	3	418	82136	1	419	82420	1	432, 550	83612	9	508	83842	0	249
81204	8	415	82001	2	251, 421, 424	82137	8	419	82440	9	432, 554	83613	6	508	83843	7	249
81206	2	415	82003	6	421	82138	5	419	82441	6	432, 554	83616	7	508	83848	2	250, 313
81208	6	415	82004	3	421	82140	8	419	82828	5	196	83648	8	249	83849	9	250, 313
81209	3	415	82005	0	421	82142	2	419	82829	2	196	83649	5	249	83851	2	250, 313
81292	5	417	82006	7	421	82150	7	419	82831	5	197	83696	9	40, 242	83867	3	71
81295	6	417	82007	4	421	82151	4	419	83310	4	71	83697	6	40, 242	83868	0	71
81296	3	423	82008	1	421	82159	0	419	83311	1	71	83698	3	40, 242	83869	7	233, 241
81300	7	415	82009	8	421	82200	9	422	83401	9	232	83699	0	40, 242	83878	9	247
81301	4	415	82010	4	421	82210	8	394, 397	83402	6	232	83700	3	21, 40, 242, 243, 573	83879	6	247
81302	1	415	82011	1	421	82211	5	84, 402	83403	3	158, 232, 289	83701	0	21, 40, 242, 243, 573	83880	2	106, 242
81304	5	415	82012	8	421	82215	3	394, 397	83405	7	232	83702	7	21, 40, 242	83881	9	242, 243, 573
81306	9	415	82013	5	251, 421, 424	82241	2	64, 275	83406	4	232	83703	4	21, 40, 242	83884	0	155, 233, 569
81308	3	415	82014	2	421	82242	9	275	83407	1	232	83704	1	40, 242, 243, 573	83887	1	248
81391	5	417	82016	6	421	82249	4	77	83408	8	233, 235, 573	83705	8	40, 242, 243, 573	83888	8	248
81395	3	417	82017	3	421	82250	1	77	83409	5	233, 235, 573	83712	6	204	83889	5	248
81400	4	415	82018	0	421	82252	8	77	83410	1	233	83716	4	205	83890	1	153, 155, 240, 569
81401	1	415	82019	7	251, 421, 424	82253	5	77	83414	9	233	83718	8	206	83892	5	153, 240
81402	8	415	82020	3	421	82255	9	76	83415	6	233	83720	1	206	83893	2	153, 240
81402	8	415	82022	7	421	82256	6	76	83417	0	158, 232, 289	83721	8	205	83897	0	250, 431
81404	2	415	82023	4	421	82257	3	76	83418	7	232	83722	5	206	83900	7	236
81406	6	415	82028	9	421	82265	8	76	83419	4	233	83723	2	205	83901	4	236
81408	0	415	82029	6	251, 421, 424	82266	5	76	83433	0	158, 232, 289	83724	9	206	83902	1	236
81492	9	417	82030	2	421	82267	2	76	83434	7	232	83725	6	205	83903	8	236
81495	0	417	82032	6	421	82270	2	422	83450	7	233	83726	3	206	83904	5	236
81502	5	415	82034	0	421	82271	9	422	83451	4	233	83727	0	205	83905	2	236
81504	9	415	82036	4	421	82272	6	422	83452	1	233	83728	7	206	83906	9	236
81506	3	415	82037	1	251, 421, 424	82273	3	422	83453	8	233	83730	0	206	83907	6	236
81591	9	417	82038	8	421	82274	0	405, 422	83454	5	233	83732	4	206	83908	3	236
81595	7	417	82040	1	421	82275	7	422	83455	2	233	83735	5	205	83909	0	236
81602	2	415	82042	5	421	82276	4	422				83739	3	205	83910	6	237
81604	6	415	82050	0	421	82277	1	422							83911	3	237
81606	0	415	82051	7	421	82278	8	422									
81608	4	415	82059	3	421	82279	5	422									
81611	4	416, 493	82064	7	420	82280	1	422									
81692	3	417	82065	4	420	82281	8	422									
81695	4	417	82066	1	420	82300	6	422									

83912	0	237, 247	84133	8	231	84381	3	225	84571	8	202, 203	84815	3	189	85024	8	180
83913	7	237, 247	84134	5	231	84400	1	197	84572	5	203	84816	0	189	85025	5	180
83914	4	237	84135	2	231	84401	8	197	84573	2	203	84819	1	189	85026	2	180
83915	1	237	84158	1	230, 248	84402	5	197	84574	9	203	84820	7	196	85027	9	180
83916	8	237, 573	84161	1	200	84403	2	197	84575	6	202	84821	4	196	85028	6	180
83917	5	237, 573	84170	3	200	84404	9	197	84576	3	202	84824	5	197	85029	3	181
83918	2	42, 237, 573	84171	0	200	84408	7	235	84577	0	203	84825	2	196	85030	9	181
83919	9	237, 573	84172	7	200	84409	4	235	84578	7	203	84826	9	196	85036	1	181
83921	2	237, 573	84174	1	223	84417	9	235	84579	4	203	84827	6	196	85037	8	181
83922	9	237, 573	84177	2	155, 221, 569	84418	6	235	84580	0	203	84828	3	196	85038	5	181
83923	6	237	84178	9	221	84422	3	235	84581	7	202, 203	84829	0	196	85040	8	241
83924	3	237	84179	6	221	84423	0	235	84582	4	203	84830	6	197	85041	5	241
83925	0	237	84180	2	217	84424	7	233	84583	1	213, 572	84831	3	197	85042	2	241
83926	7	237	84181	9	217	84425	4	233	84584	8	213, 572	84835	1	197	85043	9	241
83929	8	204	84182	6	217	84426	1	233	84586	2	213	84836	8	92, 197	85051	4	568, 569
83932	8	206	84185	7	30, 217	84427	8	233	84587	9	213	84837	5	197	85052	1	568, 569
83933	5	206	84186	4	30, 217	84430	8	235	84589	3	213	84860	3	71	85055	2	181
83935	9	206	84187	1	56, 217	84434	6	221	84590	9	213	84862	7	71	85056	9	181
83941	0	207	84188	8	30, 217	84444	5	245	84592	3	214	84863	4	71	85057	6	181
83946	5	207	84189	5	30, 217	84445	2	245	84593	0	214	84900	6	198	85060	6	177
83947	2	207	84200	7	239	84446	9	245	84605	0	212, 572	84901	3	198	85061	3	177
83949	6	207	84205	2	216	84448	3	245	84606	7	212, 572	84902	0	198	85062	0	177
83955	7	218	84206	9	216	84449	0	245	84607	4	212, 572	84903	7	198	85063	7	176
83956	4	218	84207	6	216	84450	6	245	84608	1	212, 572	84904	4	199	85064	4	176
83957	1	218	84209	0	216	84452	0	245	84609	8	212	84905	1	199	85065	1	176
83958	8	218	84215	1	243	84454	4	245	84610	4	212	84906	8	199	85066	8	176
83960	1	238	84216	8	243	84456	8	245	84611	1	212	84907	5	199	85067	5	42, 176
83961	8	238	84217	5	231, 246	84458	2	245	84612	8	212	84908	2	60, 199	85068	2	42, 176
83962	5	238	84220	5	243	84460	5	249	84613	5	212	84909	9	199	85069	9	177
83971	7	218	84221	2	242	84462	9	239	84614	2	212	84910	5	199	85070	5	177
83980	9	218	84230	4	238	84470	4	244, 271	84671	5	190	84911	2	199	85071	2	177
83981	6	219	84231	1	238	84471	1	244, 271	84672	2	190	84912	9	199	85072	9	177
83992	2	219	84244	1	219, 234, 573	84472	8	244, 271	84673	9	190	84920	4	208, 210	85073	6	176
83994	6	219	84245	8	219, 234, 573	84490	2	201	84674	6	190, 191	84921	1	210	85074	3	178
84018	8	246, 271	84251	9	145, 502	84491	9	201	84675	3	190, 191	84922	8	210	85075	0	178
84020	1	250	84253	3	145, 502	84492	6	201	84676	0	190, 191	84923	5	209, 210	85076	7	178
84021	8	250	84257	1	220	84494	0	201	84677	7	190, 191	84924	2	208, 210	85077	4	178
84035	5	250	84258	8	220	84509	1	186	84678	4	190, 191	84925	9	209, 210	85080	4	64, 183, 283
84040	9	241	84259	5	220	84510	7	186	84680	7	192	84926	6	208, 211	85081	1	64, 183, 283
84041	6	241	84295	3	243	84511	4	186	84681	4	192	84927	3	209, 210, 211	85082	8	183
84042	3	241	84300	4	251, 424	84512	1	186	84682	1	192	84928	0	208, 210, 211	85083	5	183
84043	0	241	84301	1	251, 424	84514	5	186	84683	8	192	84929	7	209, 210, 211	85092	7	178
84045	4	151, 503	84302	8	251, 424	84515	2	186	84684	5	193	84930	3	208, 212, 273, 572	85093	4	178
84046	1	25, 235	84303	5	251, 424	84517	6	186	84685	2	193	84931	0	209, 212, 572	85097	2	178
84047	8	25, 27, 235	84304	2	108, 109, 251, 424	84519	0	188	84686	9	193	84932	7	208, 212	85098	9	177
84048	5	25, 235	84305	9	108, 251, 424	84520	6	188	84687	6	193	84933	4	209, 212	85099	6	65, 219, 567
84100	0	222	84306	6	251, 424	84521	3	188	84688	3	193	84934	1	212	85100	9	184
84101	7	222	84307	3	251, 424	84522	0	188	84689	0	193	84935	8	209, 212	85101	6	184
84103	1	224	84308	0	251, 424	84523	7	187	84690	6	193	84936	5	208, 213, 572	85103	0	184
84104	8	224	84309	7	251, 424	84524	4	187	84729	3	224	84937	2	209, 213, 572	85104	7	184, 243, 573
84105	5	224	84310	3	108, 251, 424	84525	1	187	84730	9	224	84942	6	209	85105	4	184, 243, 573
84106	2	224	84311	0	108, 251, 424	84526	8	187	84731	6	222	84943	3	208, 210, 211, 569	85107	8	184, 243, 573
84107	9	223	84329	5	195	84528	2	187	84732	3	222	84944	0	210, 211, 569	85108	5	184
84108	6	223	84331	8	195	84529	9	187, 464	84733	0	222	84948	8	214	85109	2	92, 184
84109	3	223	84335	6	195	84530	5	187, 464	84750	7	244	84950	1	201	85111	5	184
84110	9	223	84337	0	195	84548	0	214	84775	0	246	84951	8	201	85112	2	568
84111	6	223	84348	6	205	84555	8	213, 572	84776	7	246	84958	7	201	85113	9	184
84112	3	223	84349	3	205	84556	5	213, 572	84777	4	246	84959	4	201, 213	85116	0	184
84113	0	223	84351	6	205	84558	9	213, 572	84778	1	246	84962	4	212, 572	85120	7	184, 185
84115	4	223	84353	0	205	84559	6	213, 572	84779	8	246	84963	1	212, 572	85121	4	185
84116	1	223	84355	4	204	84561	9	213, 214, 573	84780	4	246	84964	8	212, 572	85124	5	185
84117	8	224	84365	3	225	84562	6	213, 214, 573	84781	1	246	84965	5	213, 572	85125	2	185
84118	5	224	84366	0	225	84564	0	213	84782	8	246	84966	2	213, 572	85128	3	185
84119	2	224	84377	6	225	84565	7	213	84783	5	246	84967	9	213, 572	85129	0	185
84125	3	230	84378	3	225	84567	1	202	84785	9	239	84968	6	213, 572	85132	0	185
84128	4	230, 248	84379	0	225	84568	8	202	84806	1	189	85021	7	180	85133	7	185
84130	7	231	84380	6	225	84569	5	203	84807	8	189				85150	4	231
84131	4	231				84570	1	203	84808	5	189				85151	1	231

85200	6	182	88228	7	268	88921	7	534	93170	1	483	93332	3	462
85201	3	182	88229	4	268	88922	4	534	93171	8	473	93333	0	462
85202	0	182	88256	0	552	88923	1	534	93173	2	474	93334	7	465
85203	7	182	88271	3	550	88928	6	534	93174	9	474	93335	4	465
85204	4	182	88285	0	423	88929	3	536	93175	6	474	93336	1	464
85205	1	182	88287	4	558	88930	9	536	93176	3	473	93337	8	464
85206	8	182	88288	1	558	88932	3	534	93179	4	467	93338	5	464
85207	5	182	88300	0	80, 408	88933	0	534	93180	0	470	93345	3	143, 461
85208	2	182	88301	7	80, 408	88935	4	535	93181	7	470	93346	0	460
85211	2	214	88302	4	81, 409	88937	8	535	93182	4	470	93347	7	472
85225	9	70, 500	88303	1	81, 83, 409, 411	88938	5	535	93189	3	484, 551	93348	4	472
85230	3	94, 215, 293	88304	8	81, 409	88939	2	535	93190	9	479	93349	1	472
85231	0	94, 215, 293	88305	5	81, 83, 409, 411	88940	8	535	93191	6	477	93350	7	466
85232	7	112	88306	2	82, 410	88941	5	535	93192	3	477	93351	4	468
85240	2	244, 271	88307	9	82, 410	88942	2	535	93200	5	476	93352	1	468
85241	9	244, 271	88308	6	82, 83, 410, 411	88946	0	536	93201	2	466	93353	8	468
85242	6	244, 271	88309	3	82, 410	88947	7	536	93203	6	466	93354	5	468
85243	3	244, 271	88310	9	83, 411	9			93204	3	463, 466	93355	2	468
85244	0	244, 271	88311	6	83, 411	88948	4	536	93211	1	467	93356	9	469
85250	1	240	88312	3	80, 83, 408, 411	88949	1	537, 554	93212	8	467	93357	6	469
85251	8	240	88313	0	81, 409	88950	7	545	93214	2	484, 551	93358	3	470
85252	5	240	88314	7	81, 409	88951	4	545	93220	3	476	93359	0	299, 480
85260	0	234, 573	88315	4	82, 83, 410, 411	90902	1	34	93225	8	548	93360	6	470
85261	7	234, 573	88316	1	82, 410	93034	6	471	93226	5	548	93361	3	470
85266	2	234, 573	88317	8	83, 411	93090	2	126, 453	93230	2	126	93362	0	470
85267	9	234, 573	88320	8	83, 411	93091	9	126, 453	93250	0	549	93364	4	462
85270	9	179	88598	1	555	93092	6	126, 453	93251	7	549	93365	1	462
85271	6	179	88608	7	521	93093	3	126, 453	93252	4	549	93366	8	467
85272	3	179	88609	4	555	93101	5	480	93253	1	549	93367	5	460
85273	0	179	88618	6	538	93102	2	481	93254	8	549	93368	2	471
85274	7	177	88627	8	555	93105	3	126, 453	93255	5	549	93369	9	471
85275	4	176	88628	5	555	93110	7	481	93256	2	549	93371	2	463
85276	1	179	88636	0	555	93111	4	481	93257	9	549	93372	9	463
85277	8	179	88637	7	521	93112	1	469	93258	6	549	93373	6	463
85278	5	179	88639	1	538	93114	5	481	93259	3	548	93374	3	463
85279	2	179	88640	7	520	93116	9	469	93260	9	548	93375	0	465
85290	7	200	88642	1	520	93120	6	469	93261	6	548	93377	4	482
85291	4	200	88643	8	525	93121	3	469	93270	8	549	93380	4	475
85300	3	174	88644	5	525	93122	0	482	93271	5	549	93381	1	475
85301	0	174	88645	2	525	93124	4	483	93272	2	549	93382	8	475
85302	7	174	88688	9	541	93125	1	482	93273	9	549	93383	5	475
85303	4	174	88717	6	539	93129	9	471	93274	6	549	93384	2	475
85304	1	174	88810	4	530	93134	3	471	93275	3	549	93385	9	475
85305	8	175	88811	1	530	93138	1	466	93280	7	550	93386	6	475
85306	5	175	88823	4	530	93139	8	466	93281	4	550	93390	3	475
85307	2	175	88826	5	531	93140	4	466	93300	2	472	93391	0	475
85308	9	175	88827	2	531	93141	1	480	93302	6	482	93392	7	475
85309	6	175	88829	6	532	93144	2	480	93303	3	474	93393	4	475
85310	2	175	88834	0	532	93145	9	480	93304	0	474	93394	1	475
85311	9	175	88836	4	532	93146	6	480	93306	4	473	93395	8	475
85312	6	175	88839	5	532	93147	3	480	93307	1	473	93398	9	465
85320	1	194	88840	1	533	93148	0	480	93310	1	461	93399	6	465
85321	8	194	88843	2	473, 533	93152	7	471	93311	8	461	93400	9	465
85322	5	194	88846	3	473, 531	93153	4	471	93312	5	472	98120	1	42
85323	2	194	88850	0	531	93154	1	549	93313	2	472			
85324	9	194	88853	1	533	93155	8	548	93318	7	473, 539			
88080	1	553	88855	5	558	93156	5	548	93321	7	91, 429			
88081	8	553	88900	2	558	93157	2	548	93322	4	461			
88090	0	554	88901	9	558	93160	2	481	93323	1	461			
88099	3	537	88902	6	558	93161	9	481	93324	8	468			
88220	1	268	88903	3	559	93163	3	549	93325	5	466			
88221	8	268	88911	8	558	93164	0	468	93326	2	467			
88222	5	268	88912	5	558	93165	7	468	93327	9	464			
88223	2	268	88920	0	534	93166	4	474	93328	6	464			
88224	9	268				93167	1	474	93329	3	464			
88225	6	268				93168	8	474	93330	9	443, 460			
88226	3	268				93169	5	474	93331	6	462			
88227	0	268												



buffet | tabletop | bar



#### DE Impressum

Herausgeber: Assheuer + Pott GmbH & Co. KG, Talweg 11, 59846 Sundern, Tel. +49 2933 97350, [info@aps-germany.de](mailto:info@aps-germany.de), [www.aps-germany.de](http://www.aps-germany.de)  
Gestaltung: Assheuer + Pott GmbH & Co. KG - Druck: Westdeutsche Verlags- und Druckerei GmbH, Kurhessenstraße 4-6, 64546 Mörfelden-Walldorf  
Wir behalten uns das Recht vor, die angegebenen Spezifikationen jederzeit zu ändern. Irrtum, Druckfehler und technische Änderungen vorbehalten. Artikelbeschreibungen sowie Abbildungen und Fotodarstellungen sind ohne Gewähr. Alle Angebote ohne Dekoration. Alle Preise verstehen sich unverbindlich (UVP) in Euro zuzüglich der gesetzlichen Mehrwertsteuer.  
© 2024 - Die Vervielfältigung dieses Kataloges - auch wenn partial - muss ausschließlich von der Assheuer + Pott GmbH & Co. KG genehmigt werden.  
Bildnachweis: Niklas Thiemann Fotodesign · Studio CASA · Stoll GmbH – Studio für Fotografie · track by track GmbH · iStock · Envato Elements Pty Ltd.

#### GB Imprint

Editor: Assheuer + Pott GmbH & Co. KG, Talweg 11, 59846 Sundern, Germany, Tel. +49 2933 97350, [info@aps-germany.de](mailto:info@aps-germany.de), [www.aps-germany.de](http://www.aps-germany.de)  
Design: Assheuer + Pott GmbH & Co. KG - Print: Westdeutsche Verlags- und Druckerei GmbH, Kurhessenstraße 4-6, 64546 Mörfelden-Walldorf, Germany  
We reserve the right to alter at any time the specifications stated without notice. Errors, printing error and technical changes reserved. Item description as well as images and illustrations are without guaranty. All offers are without decoration. All prices are without commitment (RRP) in Euro and exclude the legal VAT prescribed by law.  
© 2024 - This catalogue may not be reproduced in whole or in part unless specific prior written authorization of Assheuer + Pott GmbH & Co. KG.  
Picture credits: Niklas Thiemann Fotodesign · Studio CASA · Stoll GmbH – Studio für Fotografie · track by track GmbH · iStock · Envato Elements Pty Ltd.

#### ES Impressum

Editor: Assheuer + Pott GmbH & Co. KG, Talweg 11, 59846 Sundern, Alemania, Tel. +49 2933 97350, [info@aps-germany.de](mailto:info@aps-germany.de), [www.aps-germany.de](http://www.aps-germany.de)  
Diseño gráfico: Assheuer + Pott GmbH & Co. KG - Impresión: Westdeutsche Verlags- und Druckerei GmbH, Kurhessenstraße 4-6, 64546 Mörfelden-Walldorf, Alemania  
Nos reservamos el derecho de efectuar modificaciones en cualquier momento, sin aviso previo. Salvo errores de imprenta o impresión o cambios técnicos. La descripción de los artículos, sus imágenes e ilustraciones son sin garantía. Los artículos se ofrecen sin decoración. Todos los precios indicados son precios sugeridos (PVR) en euros y a dichos precios se deberá añadir el impuesto sobre el valor añadido legal vigente.  
© 2024 - Todas las reproducciones, aunque parciales, de este catálogo tienen que ser autorizadas por escrito por Assheuer + Pott GmbH & Co. KG.  
Derechos de la imagen: Niklas Thiemann Fotodesign · Studio CASA · Stoll GmbH – Studio für Fotografie · track by track GmbH · iStock · Envato Elements Pty Ltd.

#### FR Impressum

Éditeur: Assheuer + Pott GmbH & Co. KG, Talweg 11, 59846 Sundern, Allemagne, Tel. +49 2933 97350, [info@aps-germany.de](mailto:info@aps-germany.de), [www.aps-germany.de](http://www.aps-germany.de)  
Design: Assheuer + Pott GmbH & Co. KG - Impression: Westdeutsche Verlags- und Druckerei GmbH, Kurhessenstraße 4-6, 64546 Mörfelden-Walldorf, Allemagne  
Nous nous réservons le droit de modifier à tout moment les spécifications. Toutes erreurs, fautes d'impression et modifications techniques sont réservées. Les descriptions d'articles, les illustrations et les photos sont sans garantie. Toutes les articles s'entendent hors décoration. Tous les prix sont donnés sans engagement (PVC) et s'entendent en Euro et T.V.A. légale en vigueur non incluse.  
© 2024 - Toute reproduction même partielle de ce catalogue est interdite sauf autorisation expresse de Assheuer + Pott GmbH & Co. KG.  
Crédit photo: Niklas Thiemann Fotodesign · Studio CASA · Stoll GmbH – Studio für Fotografie · track by track GmbH · iStock · Envato Elements Pty Ltd.



buffet | tabletop | bar

Assheuer + Pott GmbH & Co. KG  
Talweg 11, 59846 Sundern / Germany

[aps-germany.de](http://aps-germany.de)

CATALOGUE NO 50



no. 3777

